



Chipsmall Limited consists of a professional team with an average of over 10 year of expertise in the distribution of electronic components. Based in Hongkong, we have already established firm and mutual-benefit business relationships with customers from,Europe,America and south Asia,supplying obsolete and hard-to-find components to meet their specific needs.

With the principle of “Quality Parts,Customers Priority,Honest Operation,and Considerate Service”,our business mainly focus on the distribution of electronic components. Line cards we deal with include Microchip,ALPS,ROHM,Xilinx,Pulse,ON,Everlight and Freescale. Main products comprise IC,Modules,Potentiometer,IC Socket,Relay,Connector.Our parts cover such applications as commercial,industrial, and automotives areas.

We are looking forward to setting up business relationship with you and hope to provide you with the best service and solution. Let us make a better world for our industry!



Contact us

Tel: +86-755-8981 8866 Fax: +86-755-8427 6832

Email & Skype: info@chipsmall.com Web: www.chipsmall.com

Address: A1208, Overseas Decoration Building, #122 Zhenhua RD., Futian, Shenzhen, China



RSAN SERIES

Multipurpose Single-Phase Filter Compatible with High-Voltage Pulse

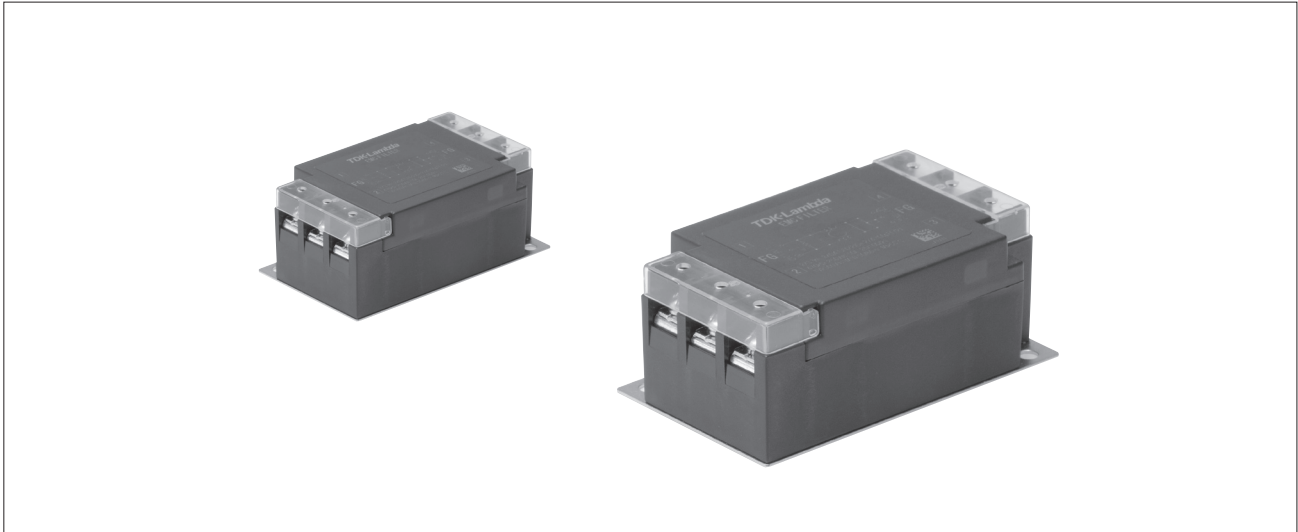

FEATURES

- Amorphous core is used as the common mode coil core for the RSEN series, which helps prevent device error.
- Self-tightening screws and an open/close type cover make wiring work easier.
- Optional low-leakage current characteristic type and DIN rail installation compatible type are also available.
- Compliant with RoHS directives.

SAFETY STANDARDS

UL1283	File No. E62388
CSA C22.2 No.8	File No. 208777
EN60939	Licence Ref. No. SE/07115-2

PRODUCT IDENTIFICATION

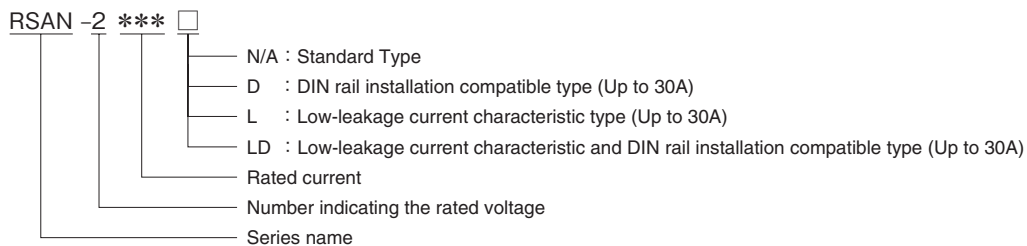

CIRCUIT DIAGRAMS

RSAN-2 ***
RSAN-2 *** D

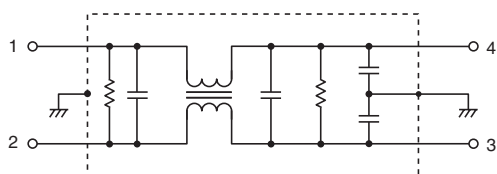

RSAN-2 *** L

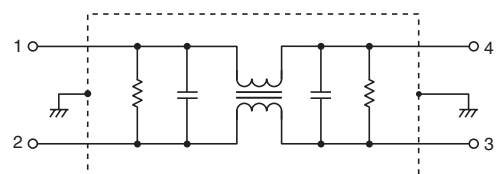

• Conformity to RoHS Directive: This means that, in conformity with EU Directive 2002/95/EC, lead, cadmium, mercury, hexavalent chromium, and specific bromine-based flame retardants, PBB and PBDE, have not been used, except for exempted applications.

• All specifications are subject to change without notice.

ELECTRICAL CHARACTERISTICS

Part No.	Rated voltage (AC/DC)	Rated current (AC/DC)	Withstand voltage	Insulation resistance	Leakage current	Operating temperature range	With derating over	DC resistance (mΩ)	Attenuation frequency range (MHz)		Weight (g)		
									Common mode			Differential mode	
									at 25dB			at 25dB	
RSAN-2003	250V	3A	AC.2500V 60s [Between line to ground]	100MΩ min. [DC.500V/ 1min]	1.0mA max. [250V/60Hz]	-25 to +85°C	55°C	250 max.	0.1 to 10	0.1 to 30	170		
RSAN-2006		6A						110 max.	0.1 to 10	0.1 to 30	230		
RSAN-2010		10A						40 max.	0.3 to 10	0.2 to 30	230		
RSAN-2016		16A						20 max.	0.8 to 10	0.3 to 30	230		
RSAN-2020		20A						10 max.	1 to 10	0.3 to 30	230		
RSAN-2030		30A						6 max.	2 to 10	0.4 to 30	230		
RSAN-2040		40A						6 max.	0.8 to 10	0.1 to 30	870		
RSAN-2050		50A						4 max.	1 to 10	0.1 to 30	870		
RSAN-2060		60A						3 max.	2 to 10	0.2 to 30	870		

Part No.	Rated voltage (AC/DC)	Rated current (AC/DC)	Withstand voltage	Insulation resistance	Leakage current	Operating temperature range	With derating over	DC resistance (mΩ)	Attenuation frequency range (MHz)			Weight (g)
									Common mode		Differential mode	
									at 20dB	at 10dB	at 25dB	
RSAN-2003L	250V	3A	AC.2500V 60s [Between line to ground]	100MΩ min. [DC.500V/ 1min]	10 μA max. [250V/60Hz]	-25 to +85°C	55°C	250 max.	0.1 to 3	-	0.1 to 30	170
RSAN-2006L		6A						110 max.	0.1 to 3	-	0.1 to 30	230
RSAN-2010L		10A						40 max.	0.5 to 6	-	0.2 to 30	230
RSAN-2016L		16A						20 max.	-	0.3 to 10	0.3 to 30	230
RSAN-2020L		20A						10 max.	-	0.5 to 8	0.3 to 30	230
RSAN-2030L		30A						6 max.	-	3 to 20	0.4 to 30	230

DERATINGS

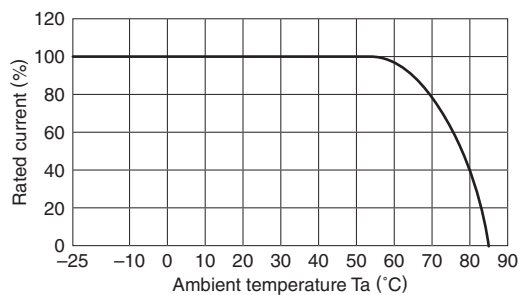

■ SHAPES AND DIMENSIONS

RSAN-2003/2006/2010/2016/2020/2030

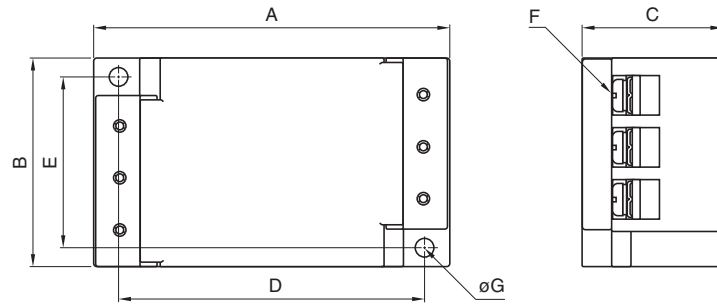

RSAN-2040/2050/2060

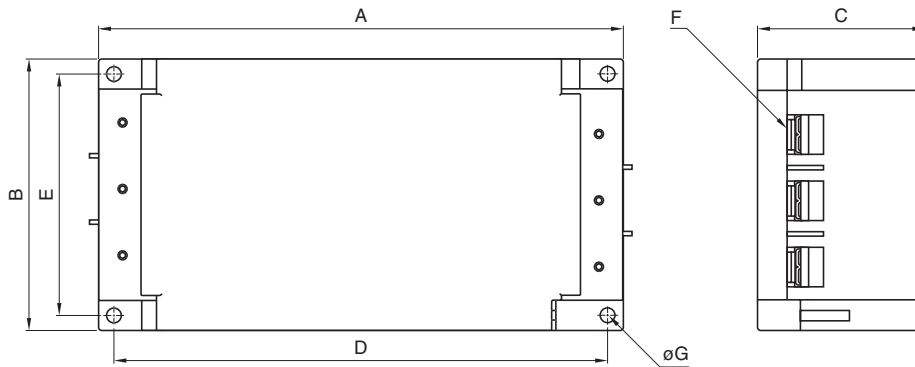

Dimensions in mm

Part No.	A	B	C	D	E	F	ϕG	Recommended clamping torque
RSAN-2003	87	52	35	75	43	M4	4.5	1.27N · m
RSAN-2006								
RSAN-2010								
RSAN-2016								
RSAN-2020								
RSAN-2030	170	90	54	160	80	M5	4.5	2.5N · m
RSAN-2040								
RSAN-2050								
RSAN-2060								

RSAN-2003D/2006D/2010D/2016D/2020D/2030D

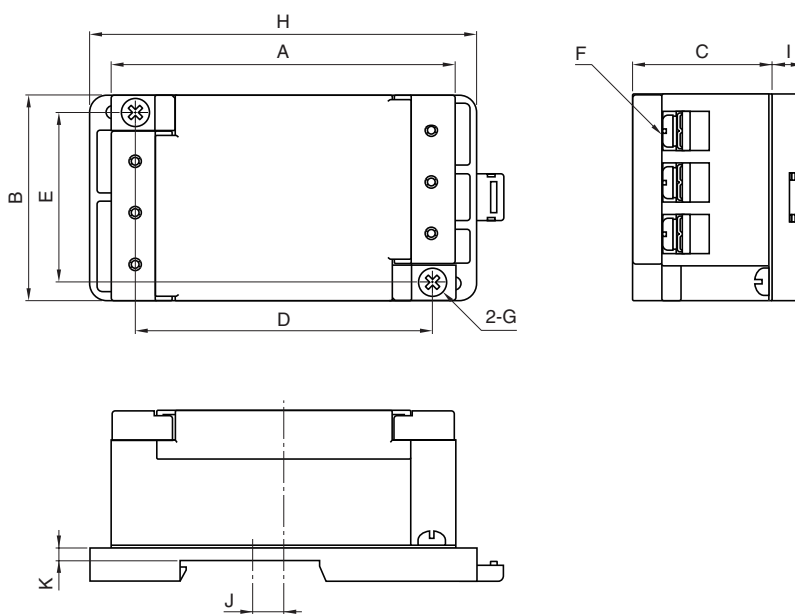

Dimensions in mm

Part No.	A	B	C	D	E	F	G	H	I	J	K
RSAN-2003D	87	52	35	75	43	M4	M4	98	8.4	8.5	3.5
RSAN-2006D											
RSAN-2010D											
RSAN-2016D											
RSAN-2020D											
RSAN-2030D											

ATTENUATION vs. FREQUENCY CHARACTERISTICS

RSAN-2003

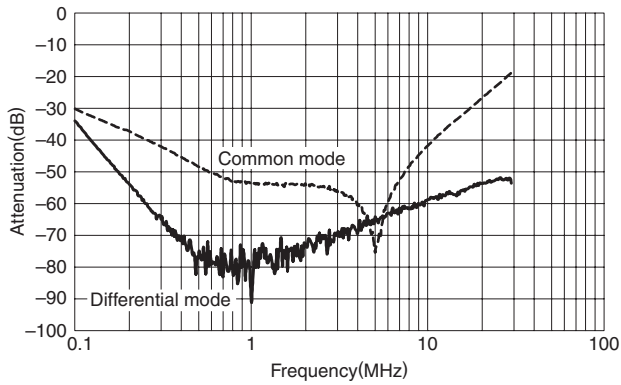

RSAN-2006

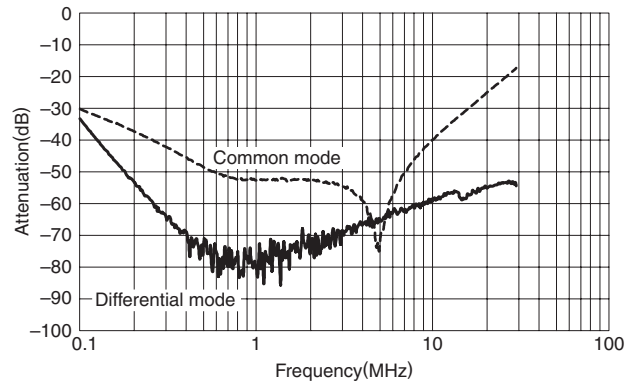

RSAN-2010

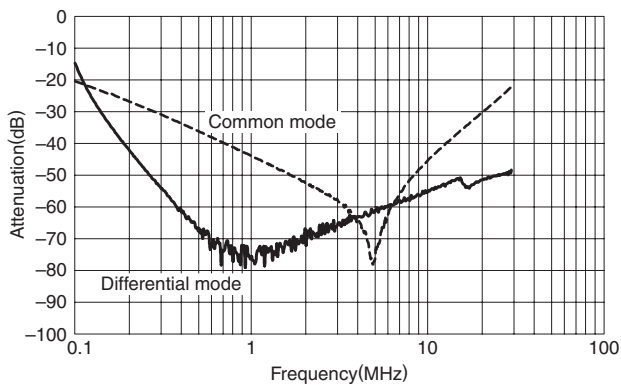

RSAN-2016

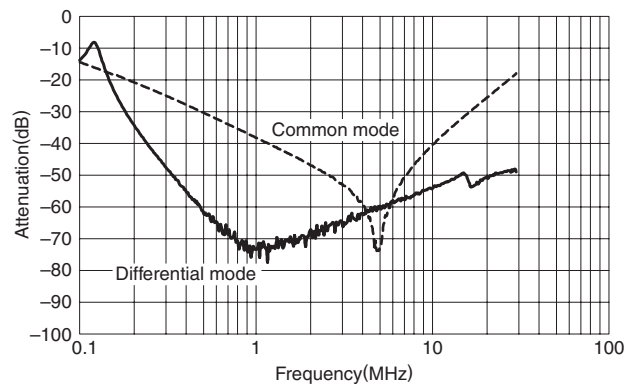

RSAN-2020

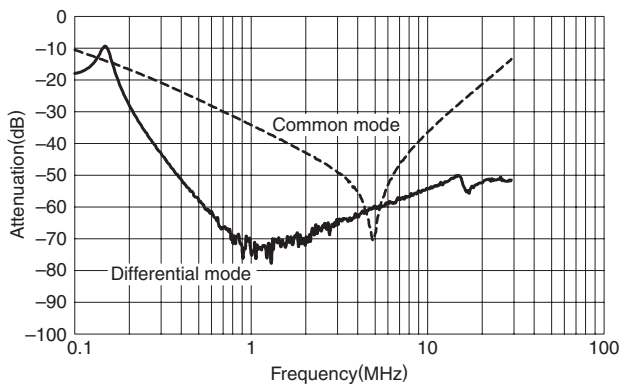

RSAN-2030

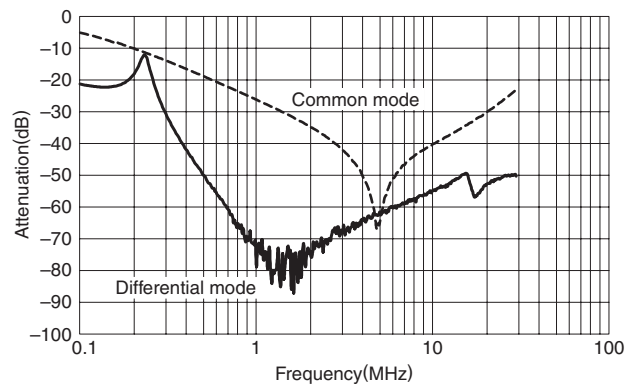

RSAN-2040

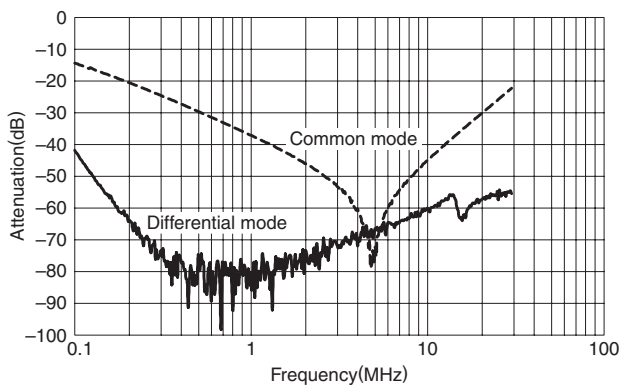

RSAN-2050

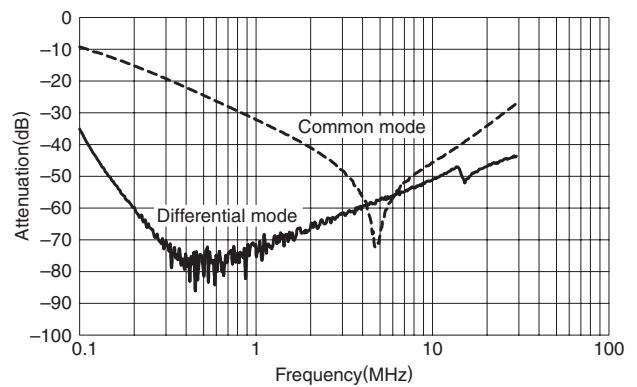

RSAN-2060

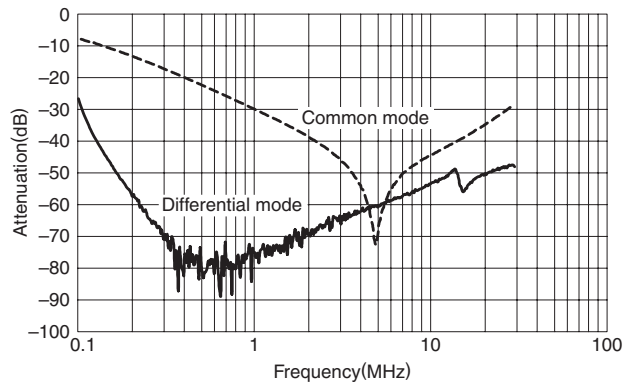

RSAN-2003L

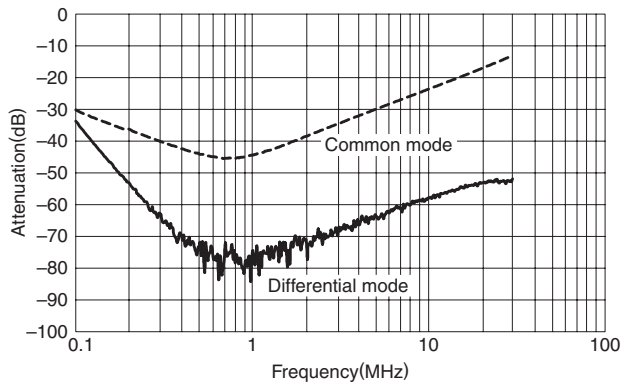

RSAN-2006L

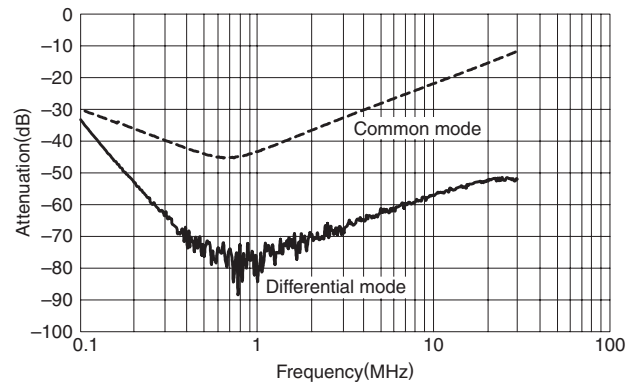

RSAN-2010L

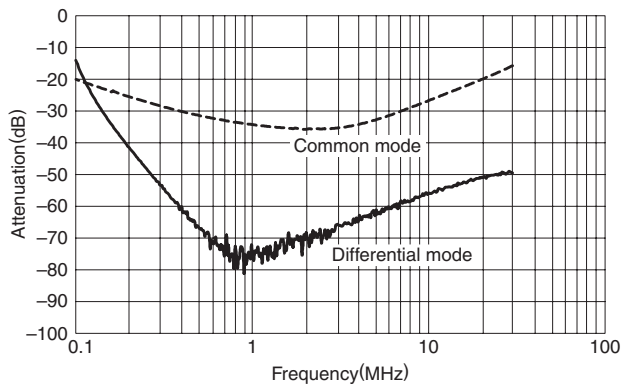

RSAN-2016L

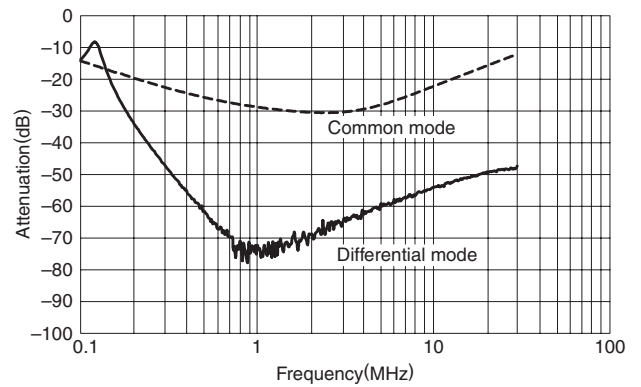

RSAN-2020L

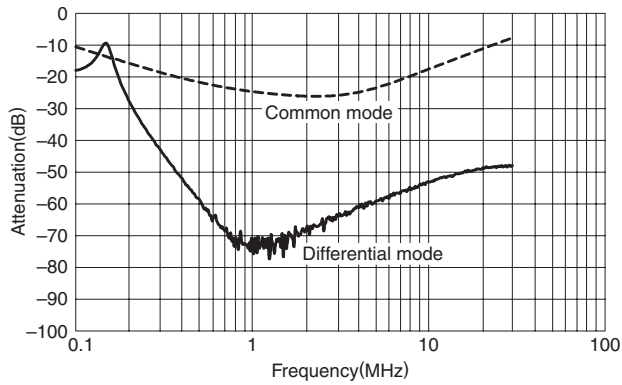

RSAN-2030L

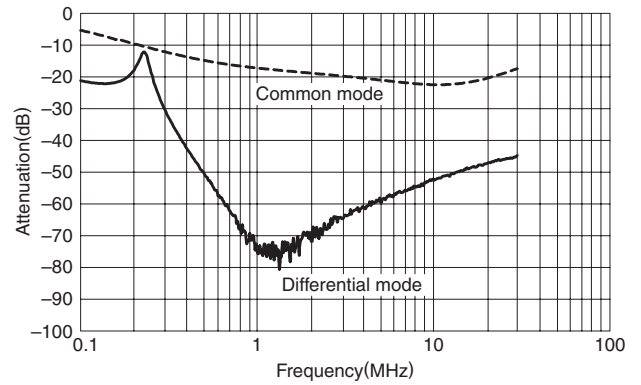

PULSE ATTENUATION CHARACTERISTICS

RSAN-2003/2003D

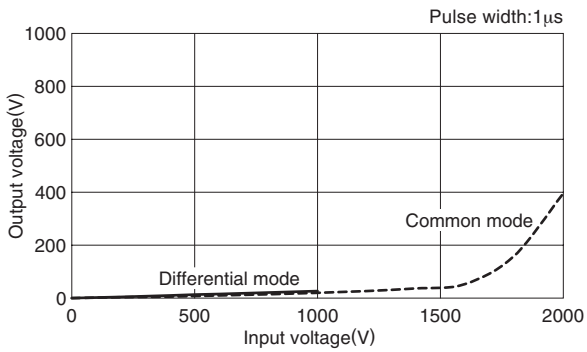

RSAN-2006/2006D

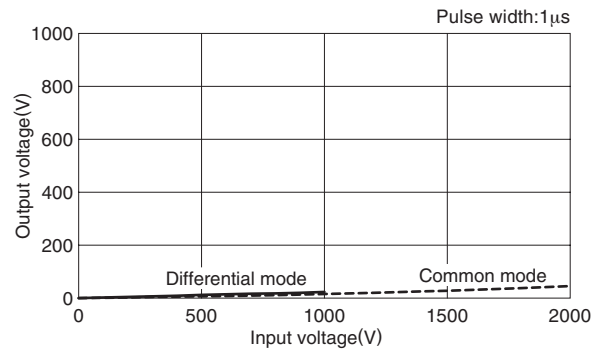

RSAN-2010/2010D

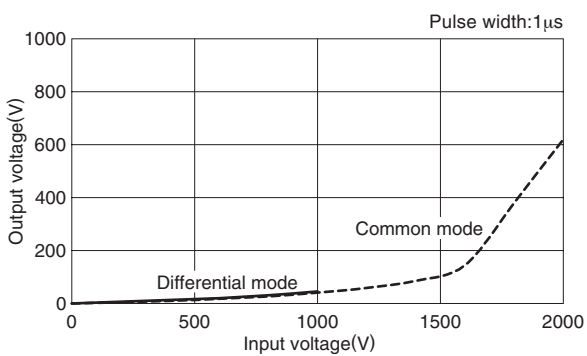

RSAN-2016/2016D

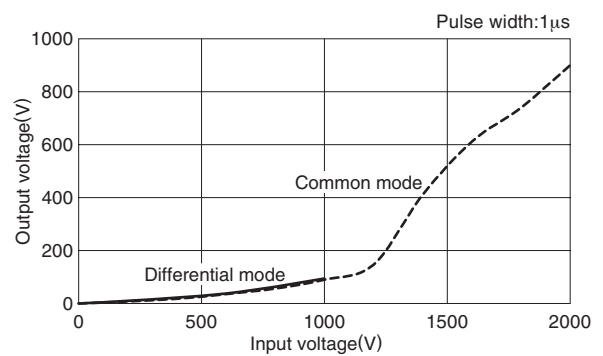

RSAN-2020/2020D

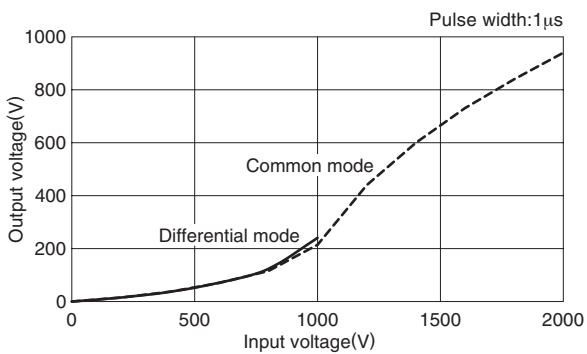

RSAN-2030/2030D

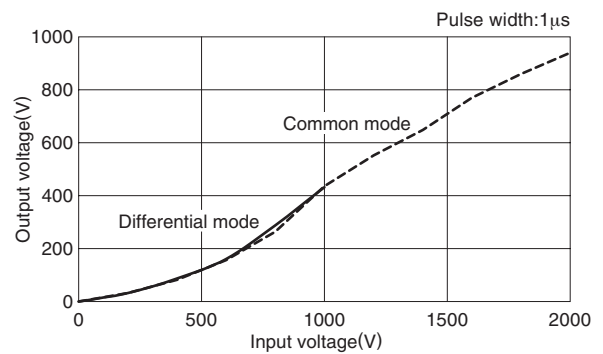

RSAN-2040

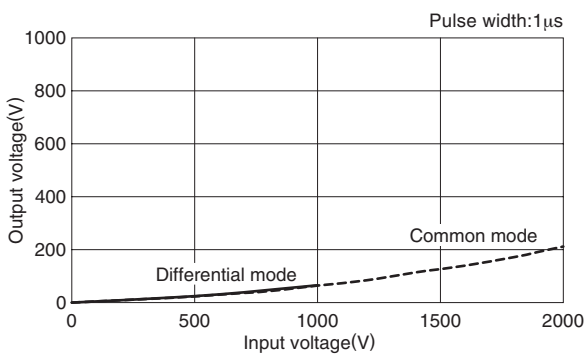

RSAN-2050

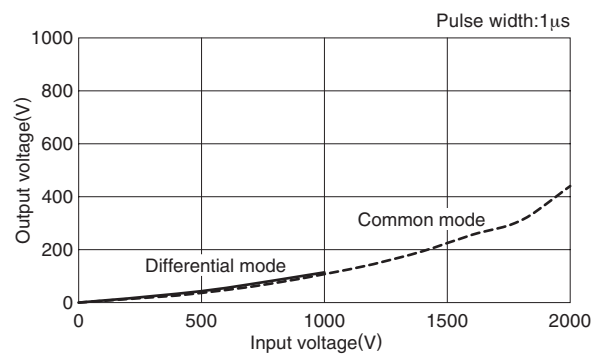

RSAN-2060

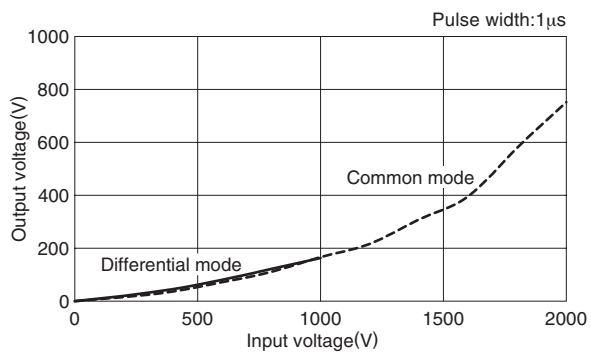

RSAN-2003L/LD

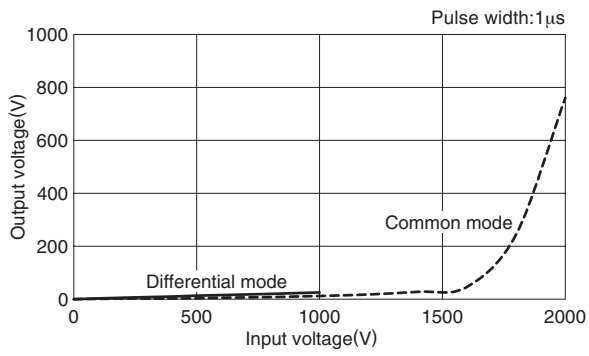

RSAN-2006L/LD

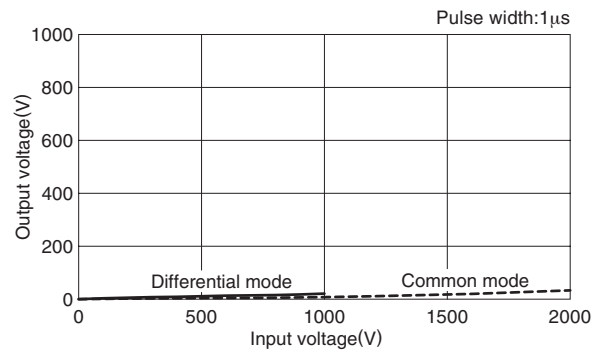

RSAN-2010L/LD

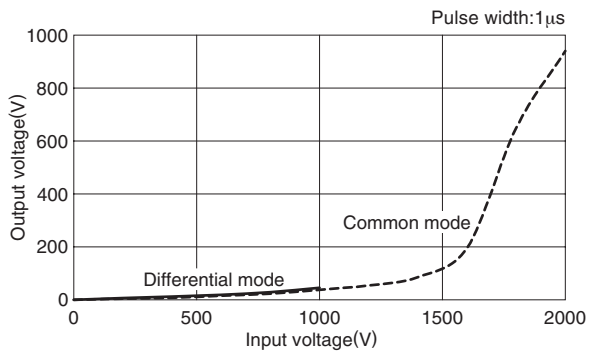

RSAN-2016L/LD

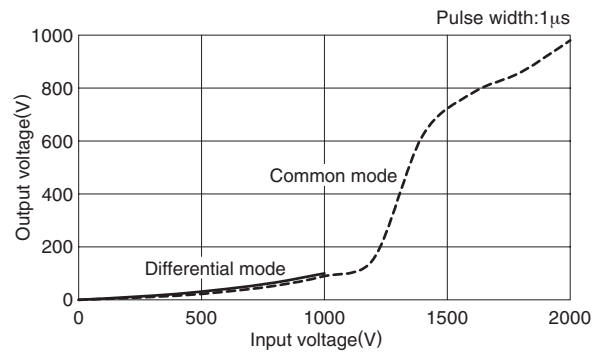

RSAN-2020L/LD

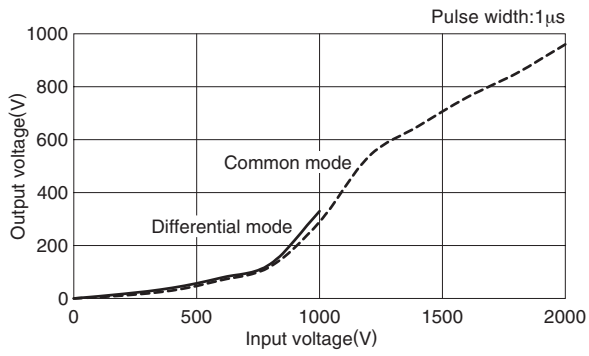

RSAN-2030L/LD

