



Chipsmall Limited consists of a professional team with an average of over 10 year of expertise in the distribution of electronic components. Based in Hongkong, we have already established firm and mutual-benefit business relationships with customers from,Europe,America and south Asia,supplying obsolete and hard-to-find components to meet their specific needs.

With the principle of “Quality Parts,Customers Priority,Honest Operation,and Considerate Service”,our business mainly focus on the distribution of electronic components. Line cards we deal with include Microchip,ALPS,ROHM,Xilinx,Pulse,ON,Everlight and Freescale. Main products comprise IC,Modules,Potentiometer,IC Socket,Relay,Connector.Our parts cover such applications as commercial,industrial, and automotives areas.

We are looking forward to setting up business relationship with you and hope to provide you with the best service and solution. Let us make a better world for our industry!



## Contact us

Tel: +86-755-8981 8866 Fax: +86-755-8427 6832

Email & Skype: info@chipsmall.com Web: www.chipsmall.com

Address: A1208, Overseas Decoration Building, #122 Zhenhua RD., Futian, Shenzhen, China



# RSMN SERIES

## Compact Multipurpose Type Compatible with High-Voltage Pulse

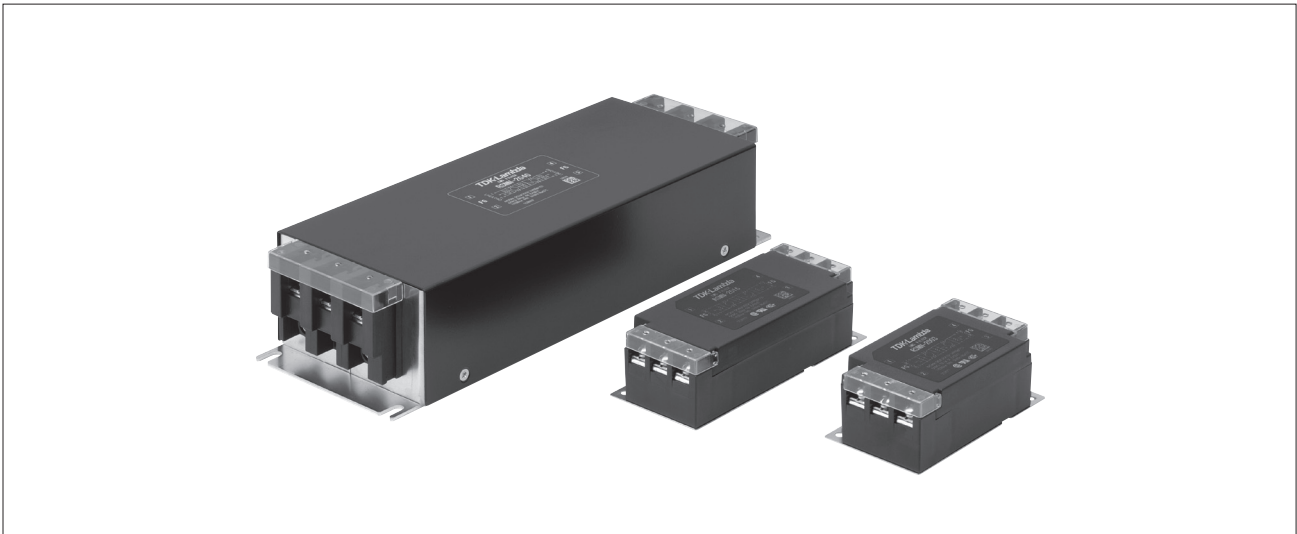

### FEATURES

- EMC filter equipped with an amorphous core as the common mode coil core for the RSHN series, which helps prevent device errors, and can also withstand current saturation.
- Self-tightening screws and an open/close type cover make wiring work easier.
- Optional low-leakage characteristic type and DIN rail installation compatible type are also available.
- Compliant with RoHS directives.

### SAFETY STANDARDS

UL1283	File No. E62388 (Up to 30A)
CSA C22.2 No.8	File No. 208777 (Up to 30A)
EN60939	Licence Ref. No. SE/07115-3 (Up to 30A)

### PRODUCT IDENTIFICATION

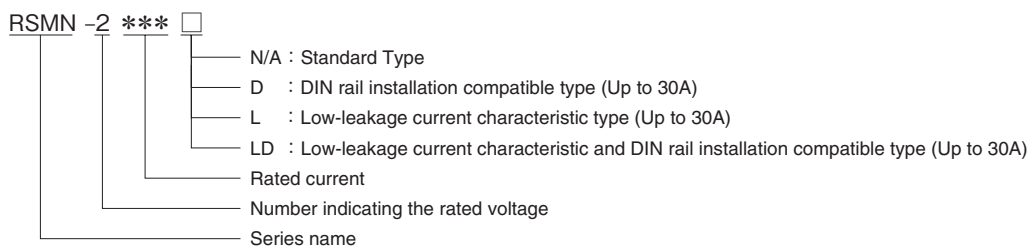

### CIRCUIT DIAGRAM

RSMN-2 \*\*\*  
RSMN-2 \*\*\* D

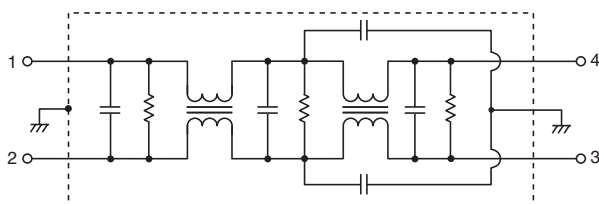

RSMN-2 \*\*\* L  
RSMN-2 \*\*\* LD

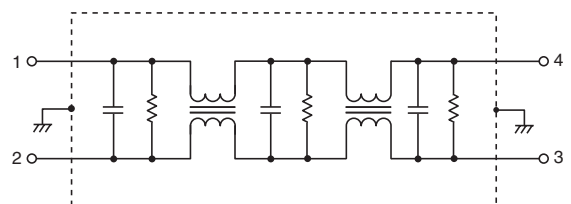

• Conformity to RoHS Directive: This means that, in conformity with EU Directive 2002/95/EC, lead, cadmium, mercury, hexavalent chromium, and specific bromine-based flame retardants, PBB and PBDE, have not been used, except for exempted applications.

• All specifications are subject to change without notice.

## ELECTRICAL CHARACTERISTICS

Part No.	Rated voltage (AC/DC)	Rated current (AC/DC)	Withstand voltage	Insulation resistance	Leakage current	Operating temperature range	With derating over	DC resistance (mΩ)	Attenuation frequency range (MHz)		Weight (g)		
									Common mode			Differential mode	
									at 25dB	at 25dB		at 25dB	at 25dB
RSMN-2003	250V	3A	AC.2500V 60s [Between line to ground]	100MΩ min. [DC.500V/ 1min]	1.0mA max. [250V/60Hz]	-25 to +85°C	55°C	350 max.	0.1 to 30	0.1 to 30	190		
RSMN-2006		6A						140 max.	0.1 to 30	0.2 to 30	240		
RSMN-2010		10A						60 max.	0.2 to 30	0.2 to 30	240		
RSMN-2016		16A						35 max.	0.2 to 30	0.3 to 30	350		
RSMN-2020		20A						22 max.	0.3 to 20	0.4 to 30	350		
RSMN-2030		30A						12 max.	0.4 to 20	0.6 to 30	350		
RSMN-2040		40A						10 max.	0.3 to 30	0.1 to 30	960		
RSMN-2050		50A						8 max.	0.4 to 30	0.3 to 30	960		
RSMN-2060		60A						6 max.	0.5 to 30	0.3 to 30	960		

Part No.	Rated voltage (AC/DC)	Rated current (AC/DC)	Withstand voltage	Insulation resistance	Leakage current	Operating temperature range	With derating over	DC resistance (mΩ)	Attenuation frequency range (MHz)			Weight (g)
									Common mode		Differential mode	
									at 25dB	at 10dB	at 25dB	
RSMN-2003L	250V	3A	AC.2500V 60s [Between line to ground]	100MΩ min. [DC.500V/ 1min]	100 μ A max. [250V/60Hz]	-25 to +85°C	55°C	350 max.	0.3 to 30	-	0.2 to 30	190
RSMN-2006L		6A						140 max.	0.4 to 20	-	0.2 to 30	240
RSMN-2010L		10A						60 max.	0.7 to 20	-	0.3 to 30	240
RSMN-2016L		16A						35 max.	0.7 to 20	-	0.3 to 30	350
RSMN-2020L		20A						22 max.	-	0.6 to 20	0.3 to 30	350
RSMN-2030L		30A						12 max.	-	1 to 20	0.4 to 30	350

## DERATINGS

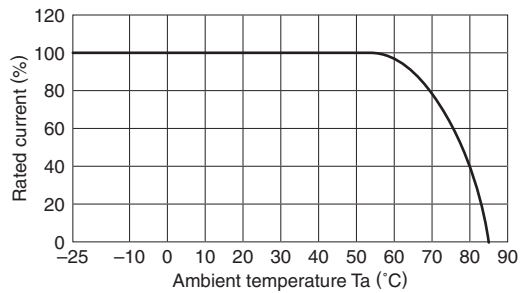

■ SHAPES AND DIMENSIONS

RSMN-2003/2006/2010/2016/2020/2030

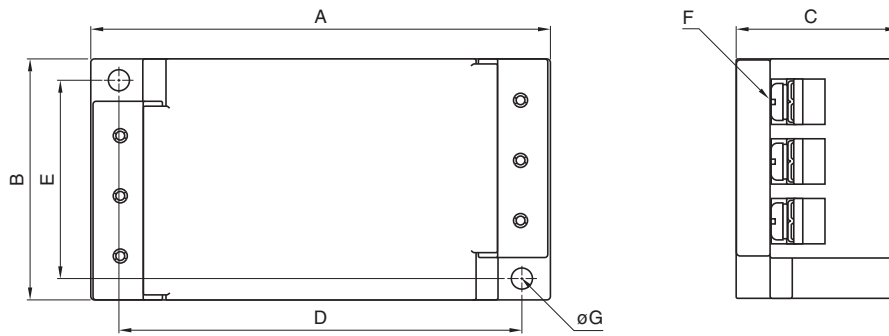

RSMN-2040/2050/2060

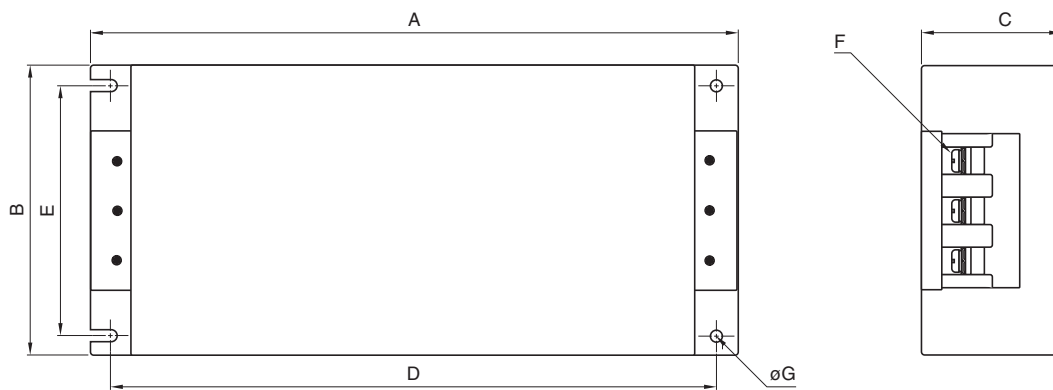

Dimensions in mm

Part No.	A	B	C	D	E	F	$\phi G$	Recommended clamping torque
RSMN-2003	98	52	35	86	43	M4	4.5	1.27N · m
RSMN-2006								
RSMN-2010								
RSMN-2016	127	52	35	115	43	M4	4.5	
RSMN-2020								
RSMN-2030								
RSMN-2040	272	100	60	254	82	M5	5.5	2.5N · m
RSMN-2050								
RSMN-2060								

RSMN-2003D/2006D/2010D

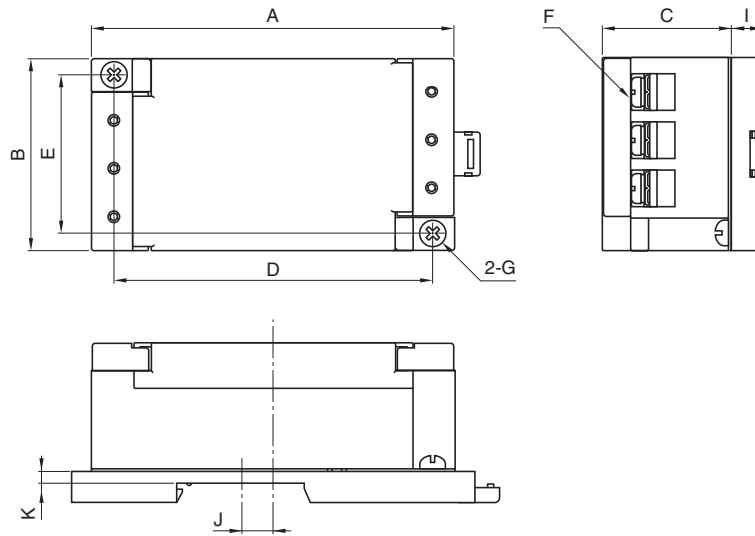

RSMN-2016D/2020D/2030D

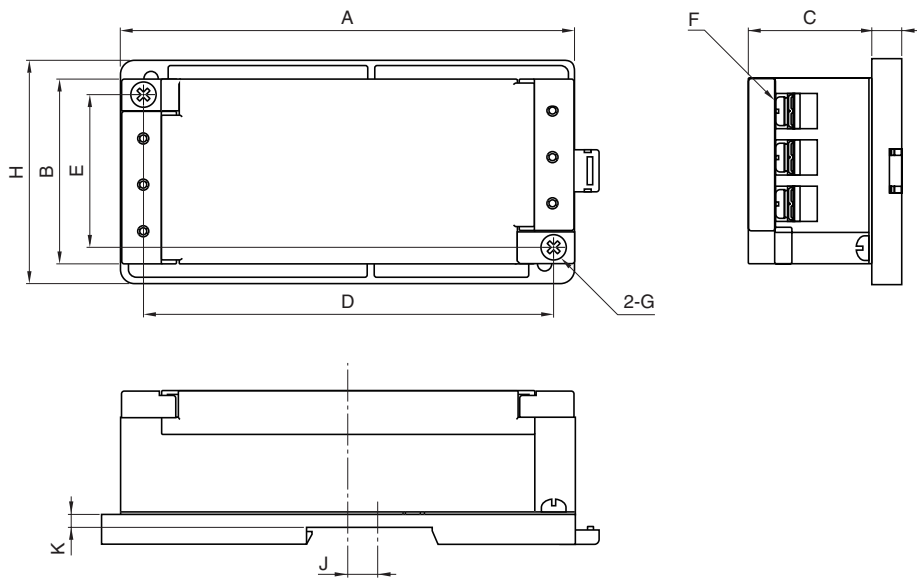

Dimensions in mm

Part No.	A	B	C	D	E	F	G	H	I	J	K
RSMN-2003D	98	52	35	86	43	M4	M4	-	8.4	8.5	3.5
RSMN-2006D											
RSMN-2010D											
RSMN-2016D	127	52	35	115	43	M4	M4	63	8.4	6	3.5
RSMN-2020D											
RSMN-2030D											



**ATTENUATION vs. FREQUENCY CHARACTERISTICS**

RSMN-2003

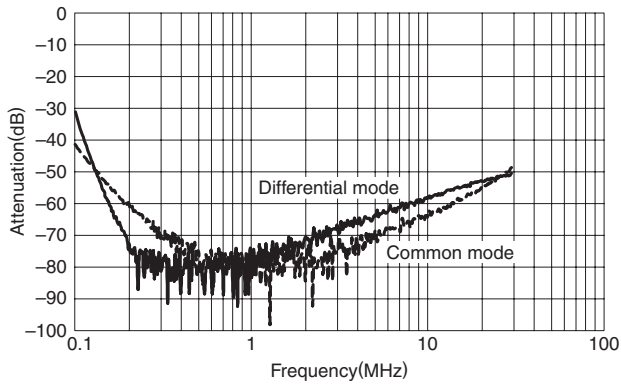

RSMN-2006

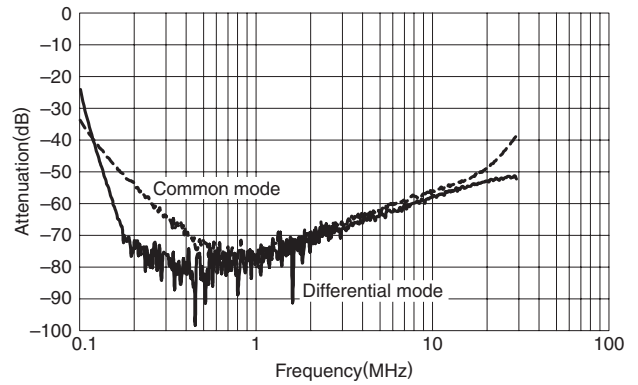

RSMN-2010

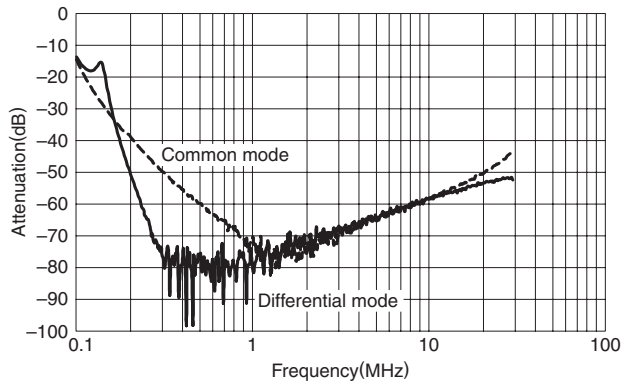

RSMN-2016

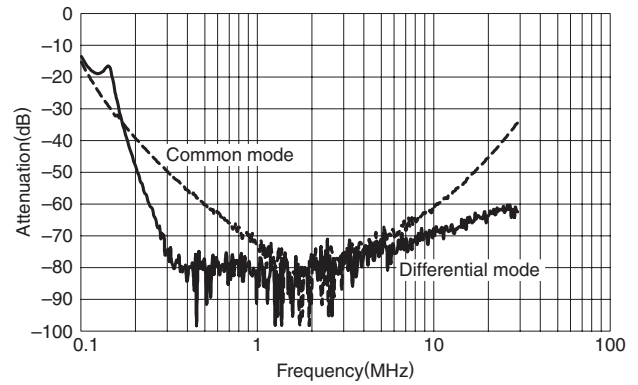

RSMN-2020

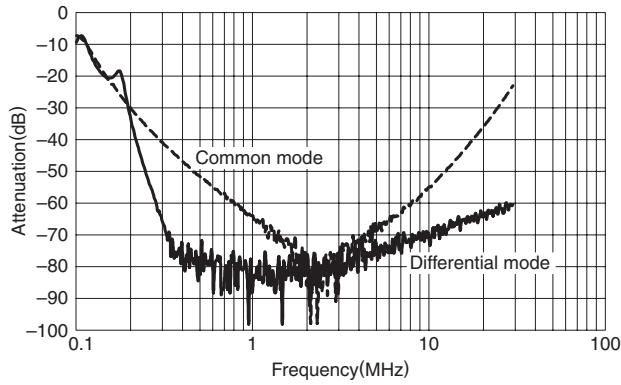

RSMN-2030

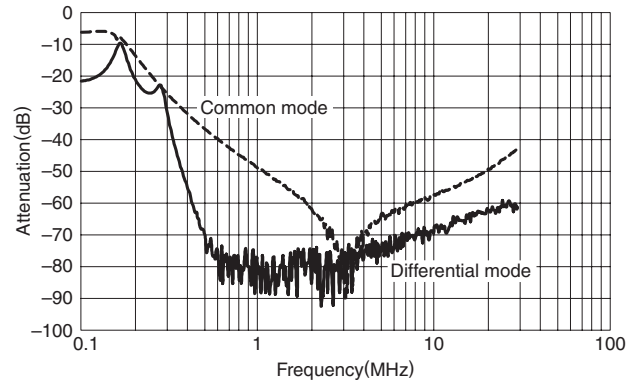

RSMN-2040

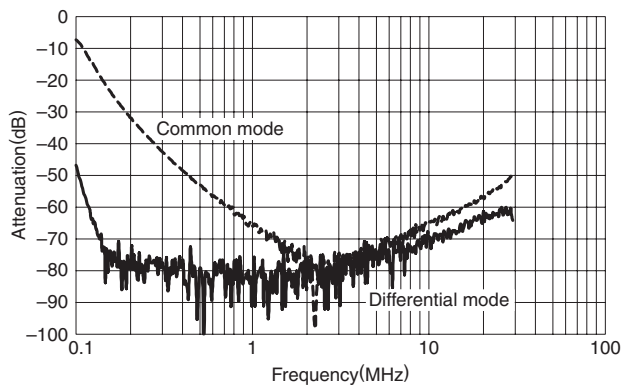

RSMN-2050

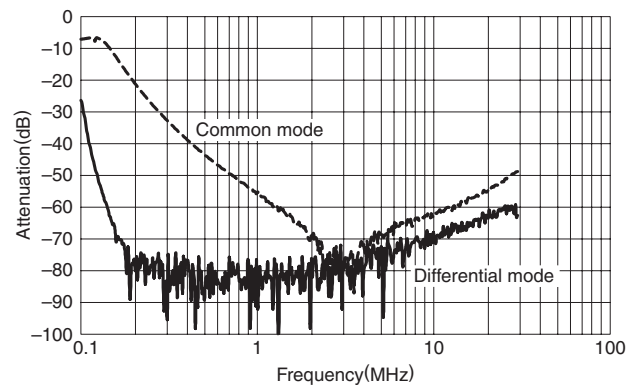

RSMN-2060

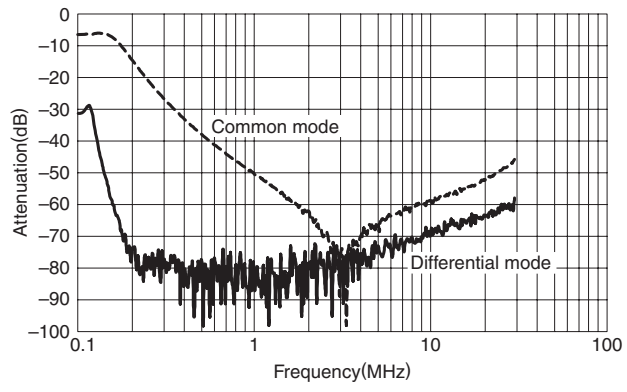

RSMN-2003L

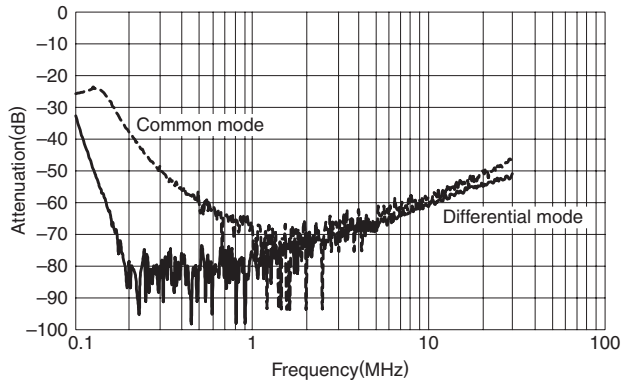

RSMN-2006L

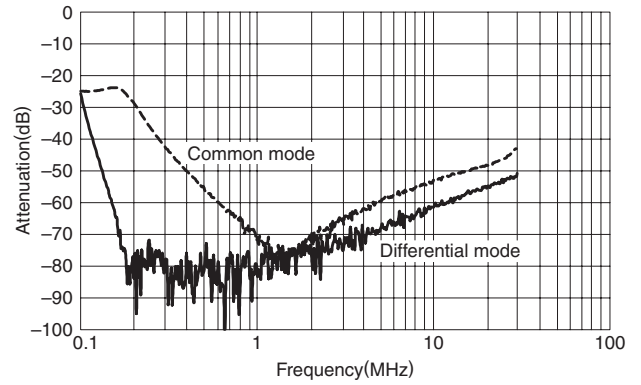

RSMN-2010L

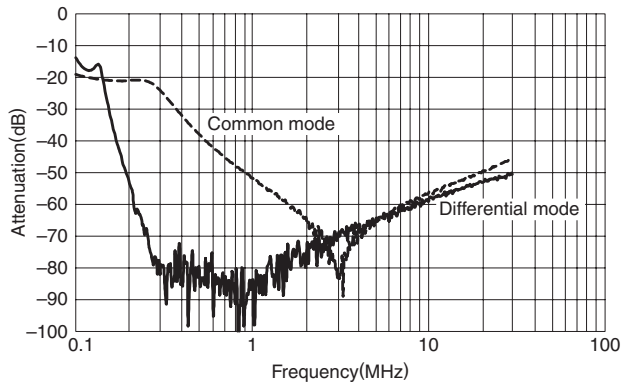

RSMN-2016L

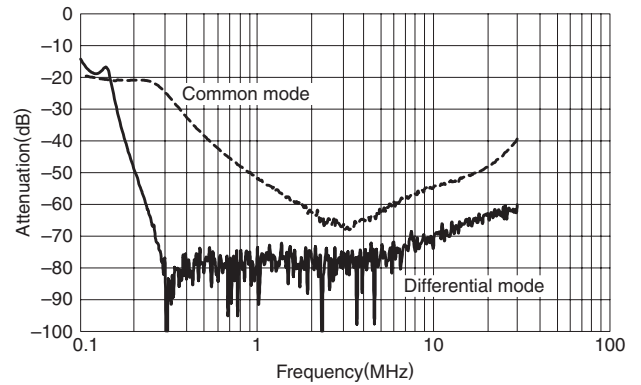

RSMN-2020L

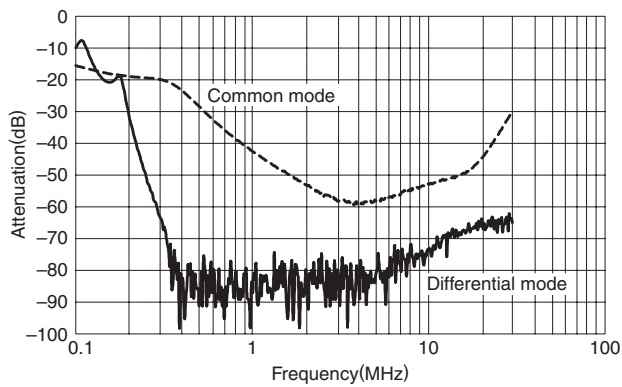

RSMN-2030L

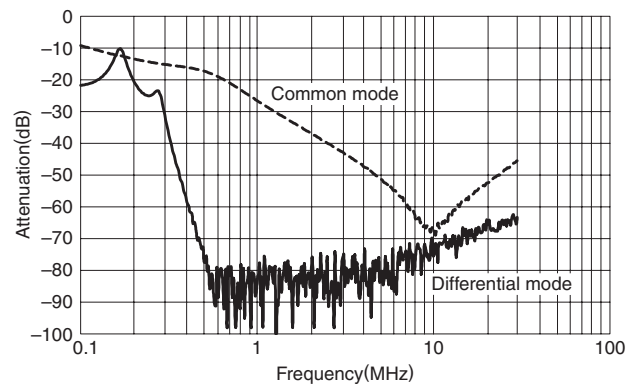



**PULSE ATTENUATION CHARACTERISTICS**

RSMN-2003/2003D

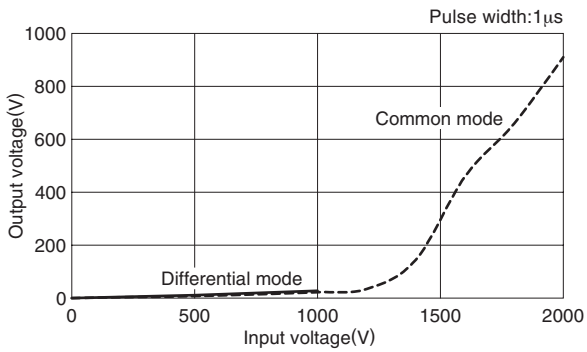

RSMN-2006/2006D

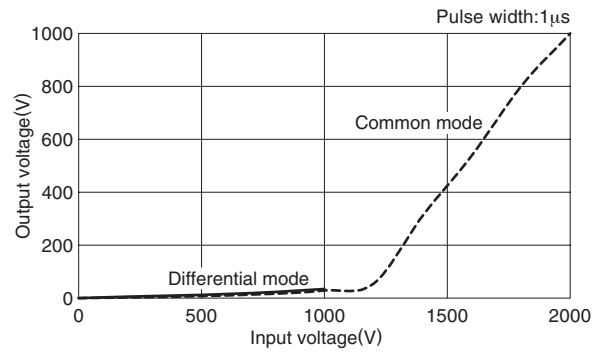

RSMN-2010/2010D

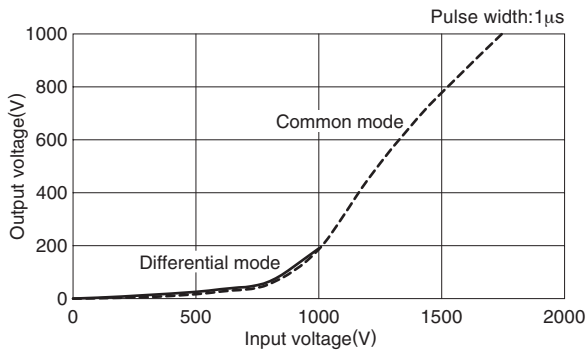

RSMN-2016/2016D

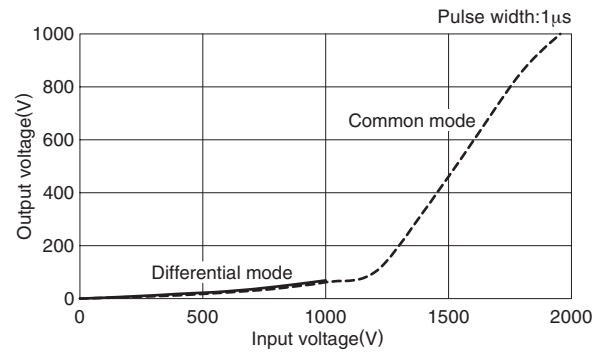

RSMN-2020/2020D

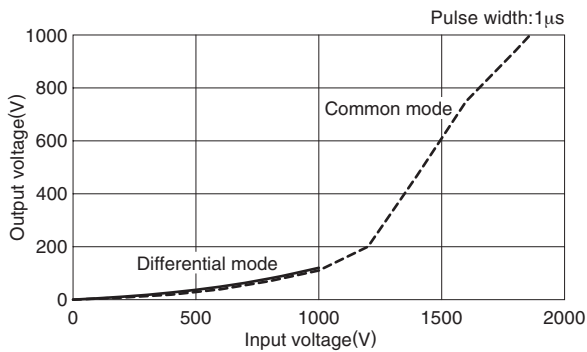

RSMN-2030/2030D

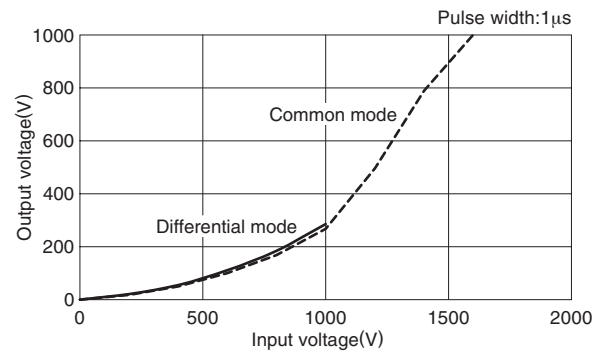

RSMN-2040

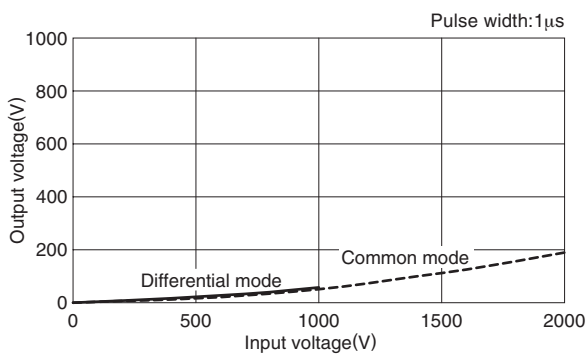

RSMN-2050

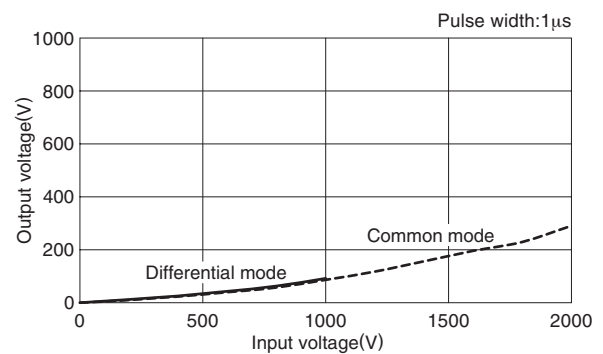

RSMN-2060

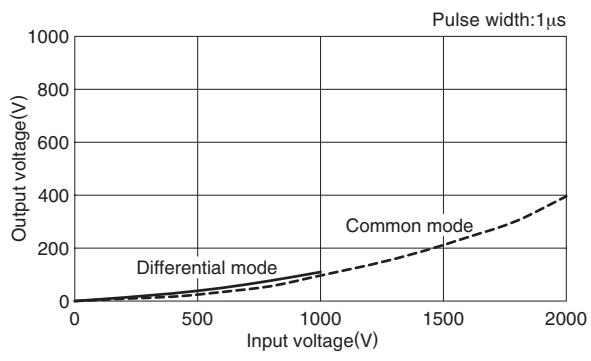

RSMN-2003L/LD

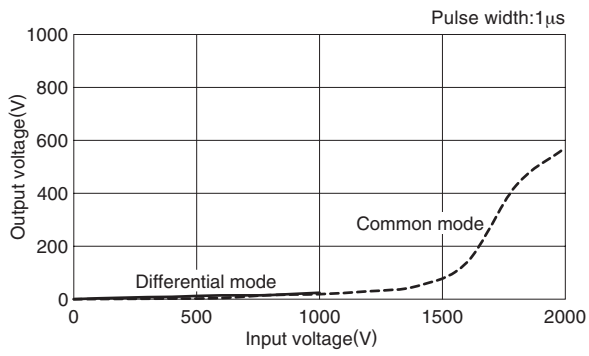

RSMN-2006L/LD

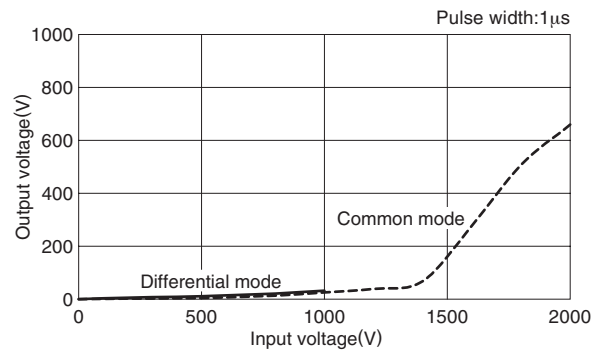

RSMN-2010L/LD

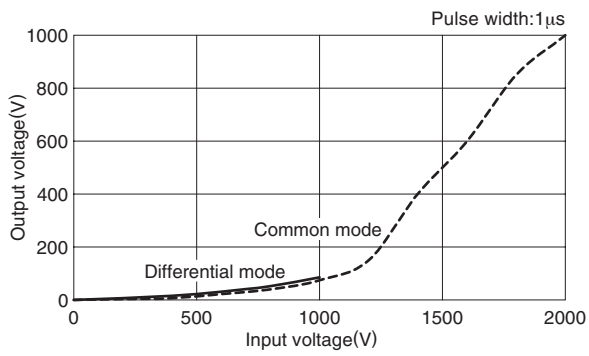

RSMN-2016L/LD

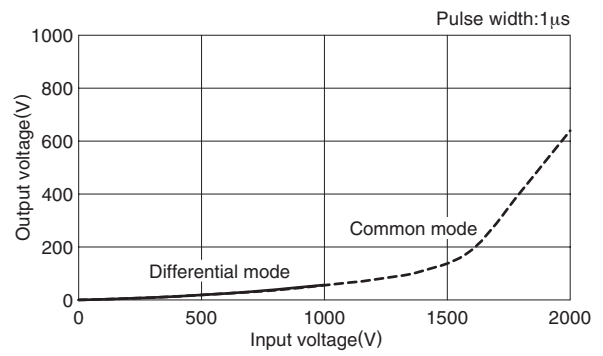

RSMN-2020L/LD

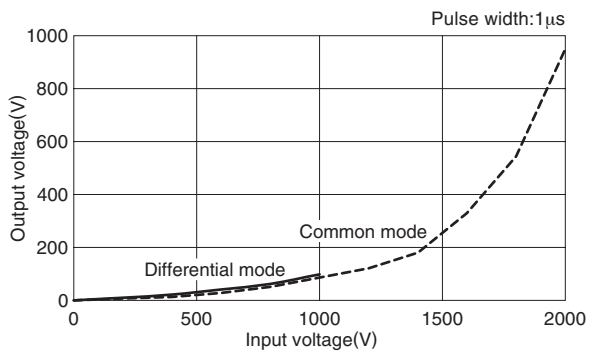

RSMN-2030L/LD

