



Chipsmall Limited consists of a professional team with an average of over 10 year of expertise in the distribution of electronic components. Based in Hongkong, we have already established firm and mutual-benefit business relationships with customers from,Europe,America and south Asia,supplying obsolete and hard-to-find components to meet their specific needs.

With the principle of "Quality Parts,Customers Priority,Honest Operation,and Considerate Service",our business mainly focus on the distribution of electronic components. Line cards we deal with include Microchip,ALPS,ROHM,Xilinx,Pulse,ON,Everlight and Freescale. Main products comprise IC,Modules,Potentiometer,IC Socket,Relay,Connector.Our parts cover such applications as commercial,industrial, and automotives areas.

We are looking forward to setting up business relationship with you and hope to provide you with the best service and solution. Let us make a better world for our industry!



## Contact us

Tel: +86-755-8981 8866 Fax: +86-755-8427 6832

Email & Skype: info@chipsmall.com Web: www.chipsmall.com

Address: A1208, Overseas Decoration Building, #122 Zhenhua RD., Futian, Shenzhen, China



# 36V, 2μA I<sub>Q</sub>, 200mA Low Dropout Voltage Linear Regulator

## General Description

The RT9069 is a low-dropout (LDO) voltage regulators with enable function offering the benefits of high input voltage, low-dropout voltage, low-power consumption, and miniaturized packaging.

The features of low quiescent current as low as 2μA and zero disable current is ideal for powering the battery equipment to a longer service life. The RT9069 is stable with the ceramic output capacitor over its wide input range from 3.5V to 36V and the entire range of output load current (0mA to 200mA).

## Applications

- Portable, Battery Powered Equipments
- Extra Low Voltage Microcontrollers
- Notebook Computers

## Marking Information

For marking information, contact our sales representative directly or through a Richtek distributor located in your area.

Note :

Richtek products are :

- ▶ RoHS compliant and compatible with the current requirements of IPC/JEDEC J-STD-020.
- ▶ Suitable for use in SnPb or Pb-free soldering processes.

## Features

- 2μA Ground Current at no Load
- ±2% Output Accuracy
- 200mA Output Current with EN
- Zero Disable Current
- Maximum Operating Input Voltage 36V
- Dropout Voltage: 0.2V at 10mA/ VIN 5V
- Support Fixed Output Voltage 2.5V, 3V, 3.3V, 5V, 9V, 12V
- Stable with Ceramic or Tantalum Capacitor
- Current Limit Protection
- Over-Temperature Protection
- RoHS Compliant and Halogen Free

## Ordering Information

RT9069-	□	□	□	□	
	Package Type				
	SP : SOP-8 (Exposed Pad-Option 1)				
	B : SOT-23-5				
	X5 : SOT-89-5				
	QU : UDFN-6L 1.6x1.6 (U-type)				
	Lead Plating System				
	G : Green (Halogen Free and Pb Free)				
	Output Voltage				
	25 : 2.5V				
	30 : 3V				
	33 : 3.3V				
	50 : 5V				
	90 : 9V				
	C0 : 12V				
	Special Request: Any Voltage between 2.5V and 12V under specific business agreement				

## Simplified Application Circuit

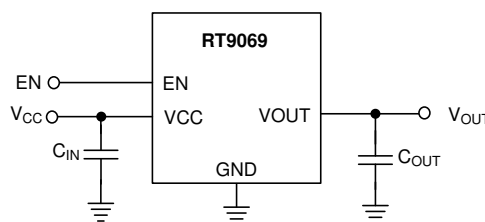

## Pin Configurations

(TOP VIEW)

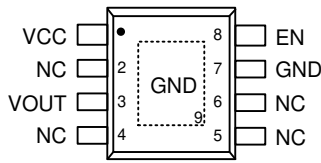

SOP-8 (Exposed Pad)

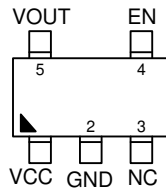

SOT-23-5

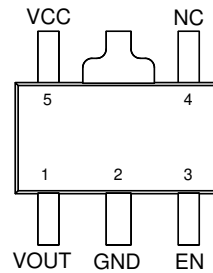

SOT-89-5

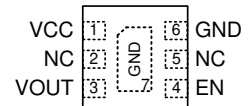

UDFN-6L 1.6x1.6

## Functional Pin Description

Pin No.				Pin Name	Pin Function
SOP-8 (Exposed Pad)	SOT-23-5	SOT-89-5	UDFN-6L 1.6x1.6		
1	1	5	1	VCC	Supply Voltage Input.
2, 4, 5, 6	3	4	2, 5	NC	No Internal Connection.
3	5	1	3	VOUT	Output of the Regulator.
7, 9 (Exposed Pad)	2	2	6, 7 (Exposed Pad)	GND	Ground. The exposed pad must be soldered to a large PCB and connected to GND for maximum thermal dissipation.
8	4	3	4	EN	Enable Control Input.

**Function Block Diagram**

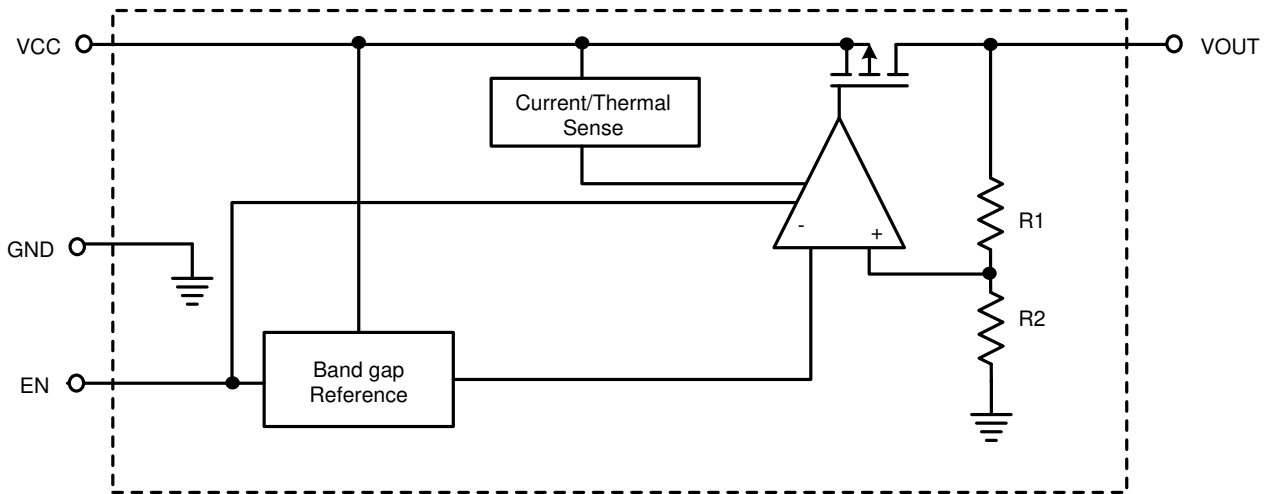

**Operation**

**Basic Operation**

The RT9069 is a high input voltage linear regulator designed especially for low external component systems. The input voltage range is from 3.5V to 36V. The minimum required output capacitance for stable operation is 1 $\mu$ F effective capacitance after consideration of the temperature and voltage coefficient of the capacitor.

**Output Transistor**

The RT9069 builds in a P-MOSFET output transistor which provides a low switch-on resistance for low dropout voltage applications.

**Error Amplifier**

The Error Amplifier compares the internal reference voltage with the output feedback voltage from the internal divider, and controls the Gate voltage of P-MOSFET to support good line regulation and load regulation at output voltage.

**Enable**

The RT9069 delivers the output power when it is set to enable state. When it works in disable state, there is no output power and the operation quiescent current is zero.

**Current Limit Protection**

The RT9069 provides current limit function to prevent the device from damages during over-load or shorted-circuit conditions. This current is detected by an internal sensing transistor.

**Over-Temperature Protection**

The over-temperature protection function turns off the P-MOSFET when the junction temperature exceeds 150°C (typ.) and the output current exceeds 4mA. Once the junction temperature cools down by approximately 20°C, the regulator automatically resumes operation.

## Absolute Maximum Ratings (Note 1)

• VCC, EN to GND	-----	-0.3V to 40V
• VOUT to VCC	-----	-40V to 0.3V
• VOUT to GND		
RT9069-90/RT9069-C0	-----	-0.3V to 15V
RT9069-25/RT9069-30/RT9069-33/RT9069-50	-----	-0.3V to 6V
• Power Dissipation, P <sub>D</sub> @ T <sub>A</sub> = 25°C		
SOP-8 (Exposed Pad)	-----	3.26W
SOT-23-5	-----	0.45W
SOT-89-5	-----	0.87W
UDFN-6L 1.6x1.6	-----	2.15W
• Package Thermal Resistance (Note 2)		
SOP-8 (Exposed Pad), $\theta_{JA}$	-----	30.6°C/W
SOP-8 (Exposed Pad), $\theta_{JC}$	-----	3.4°C/W
SOT-23-5, $\theta_{JA}$	-----	218.1°C/W
SOT-23-5, $\theta_{JC}$	-----	28.5°C/W
SOT-89-5, $\theta_{JA}$	-----	113.9°C/W
SOT-89-5, $\theta_{JC}$	-----	6.9°C/W
UDFN-6L 1.6x1.6, $\theta_{JA}$	-----	46.5°C/W
UDFN-6L 1.6x1.6, $\theta_{JC}$	-----	18.6°C/W
• Lead Temperature (Soldering, 10 sec.)	-----	260°C
• Junction Temperature	-----	150°C
• Storage Temperature Range	-----	-65°C to 150°C
• ESD Susceptibility (Note 3)		
HBM (Human Body Model)	-----	2kV

## Recommended Operating Conditions (Note 4)

• Supply Input Voltage	-----	3.5V to 36V
• Junction Temperature Range	-----	-40°C to 125°C
• Ambient Temperature Range	-----	-40°C to 85°C

## Electrical Characteristics

(V<sub>CC</sub> = 5V, C<sub>IN</sub> = 1μF, T<sub>A</sub> = 25°C, for each LDO unless otherwise specified)

Parameter	Symbol	Test Conditions	Min	Typ	Max	Unit
Supply Voltage	V <sub>CC</sub>		3.5	--	36	V
Output Voltage Range	V <sub>OUT</sub>		2.5	--	12	V
DC Output Accuracy	ΔV <sub>OUT</sub>	I <sub>LOAD</sub> = 10mA	-2	--	+2	%
Dropout Voltage	V <sub>DROP</sub>	I <sub>LOAD</sub> = 10mA, V <sub>CC</sub> > 5V	--	0.2	0.36	V

Parameter	Symbol	Test Conditions	Min	Typ	Max	Unit
V <sub>CC</sub> Consumption Current	I <sub>Q</sub>	I <sub>LOAD</sub> = 0mA, V <sub>OUT</sub> ≤ 5.5V	--	2	3.5	μA
		I <sub>LOAD</sub> = 0mA, V <sub>OUT</sub> > 5.5V, V <sub>CC</sub> = 15V	--	3.5	5	μA
Shutdown Current		V <sub>EN</sub> = 0V	--	0.1	--	μA
Shutdown Leakage Current		V <sub>EN</sub> = 0V, V <sub>OUT</sub> = 0V	--	0.1	--	μA
EN Input Current	I <sub>EN</sub>	V <sub>EN</sub> = 36V	--	0.1	--	μA
Line Regulation	ΔV <sub>LINE</sub>	I <sub>LOAD</sub> = 1mA, V <sub>OUT+1</sub> < V <sub>CC</sub> < 36V, V <sub>OUT</sub> > 3.3V	--	0.04	0.5	%
		I <sub>LOAD</sub> = 1mA, V <sub>OUT+1</sub> < V <sub>CC</sub> < 36V, V <sub>OUT</sub> ≤ 3.3V	--	0.04	0.6	
Load Regulation	ΔV <sub>LOAD</sub>	0mA < I <sub>LOAD</sub> < 100mA	-1	--	1	%
Output Current Limit	I <sub>LIM</sub>	V <sub>OUT</sub> = 0.5 × V <sub>OUT(normal)</sub>	200	350	--	mA
Enable Input Voltage	Logic-High	V <sub>IH</sub>	--	--	1.6	V
	Logic-Low	V <sub>IL</sub>	0.6	--	--	
Thermal Shutdown Temperature	T <sub>SD</sub>	I <sub>LOAD</sub> = 30mA	--	150	--	°C
Thermal Shutdown Hysteresis	ΔT <sub>SD</sub>		--	20	--	°C

**Note 1.** Stresses beyond those listed “Absolute Maximum Ratings” may cause permanent damage to the device. These are stress ratings only, and functional operation of the device at these or any other conditions beyond those indicated in the operational sections of the specifications is not implied. Exposure to absolute maximum rating conditions may affect device reliability.

**Note 2.** θ<sub>JA</sub> is measured at T<sub>A</sub> = 25°C on a high effective thermal conductivity four-layer test board per JEDEC 51-7. θ<sub>JC</sub> is measured at the exposed pad of the package.

**Note 3.** Devices are ESD sensitive. Handling precaution is recommended.

**Note 4.** The device is not guaranteed to function outside its operating conditions.

Typical Application Circuit

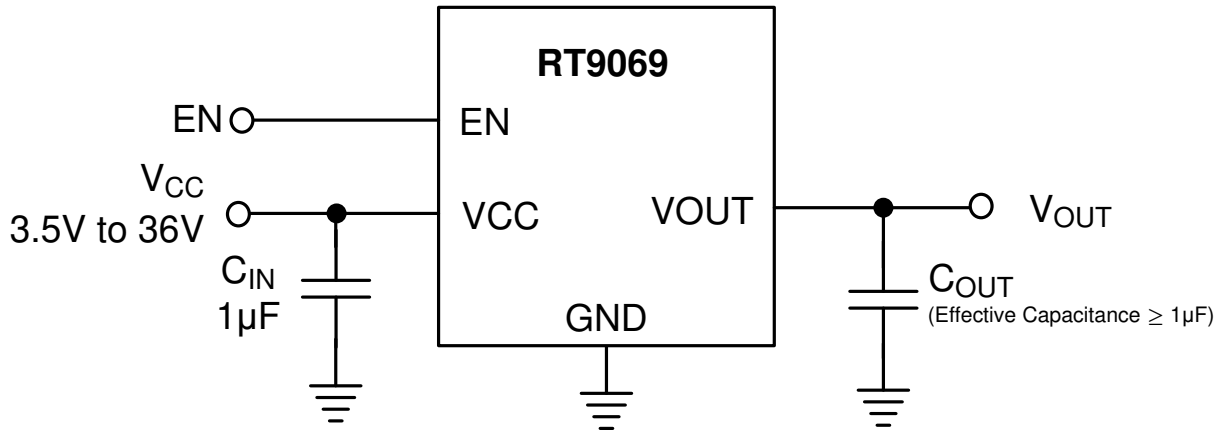

**Typical Operating Characteristics**

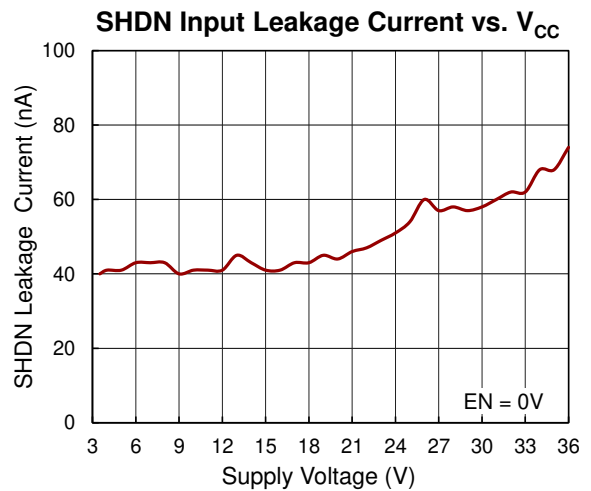
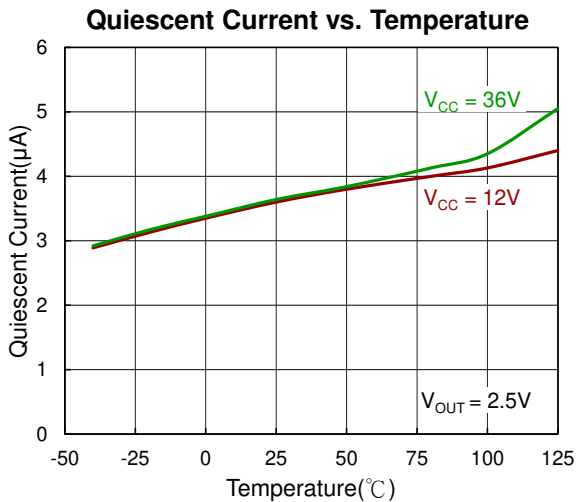
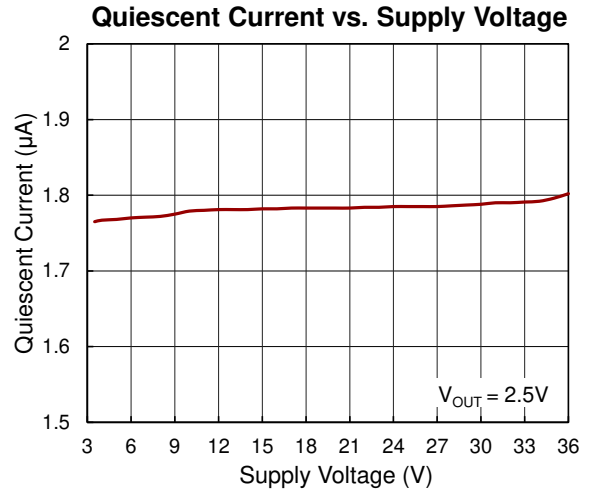
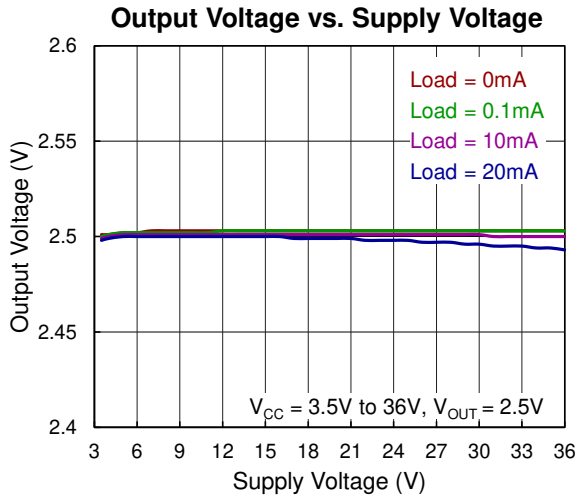
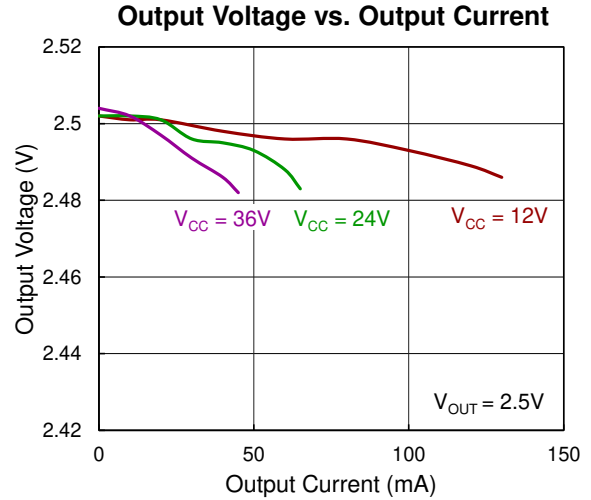
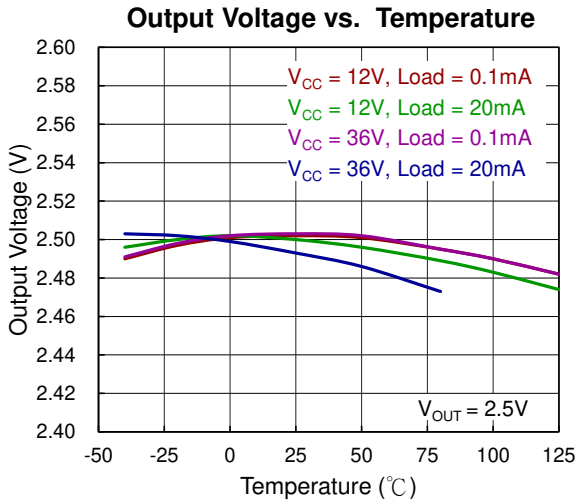



SHDN Leakage Input Current vs. Temp.

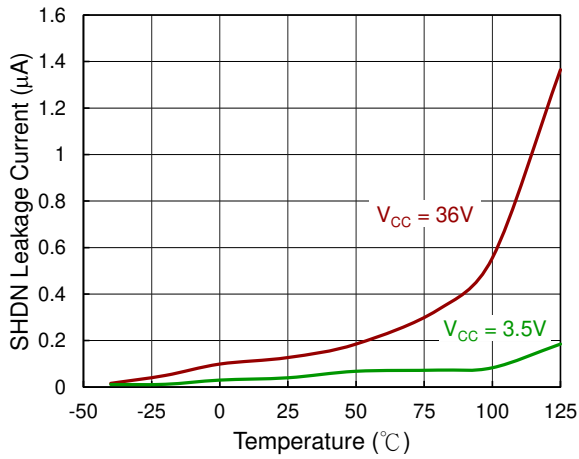

Enable Threshold vs. Supply Voltage

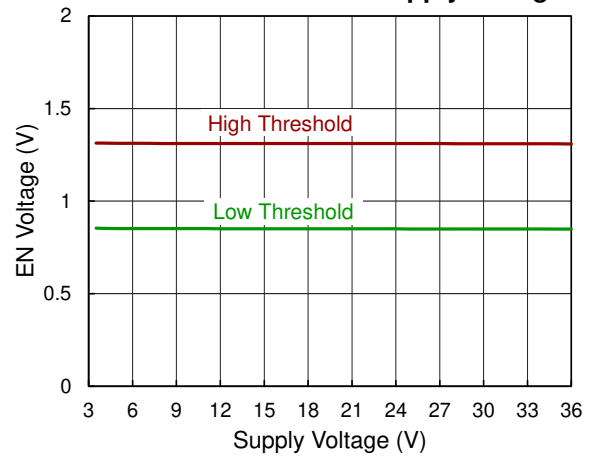

Enable Threshold vs. Temperature

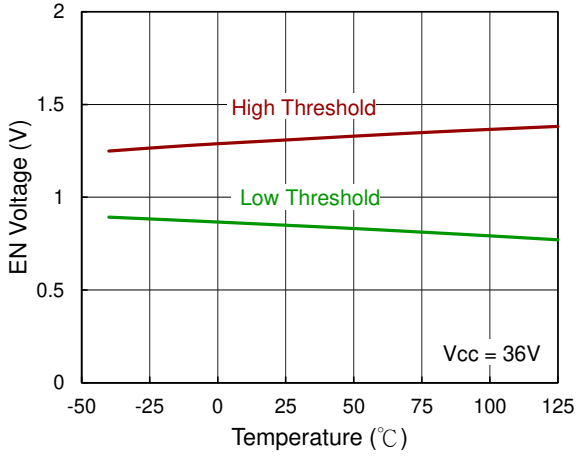

Dropout Voltage vs. Temperature

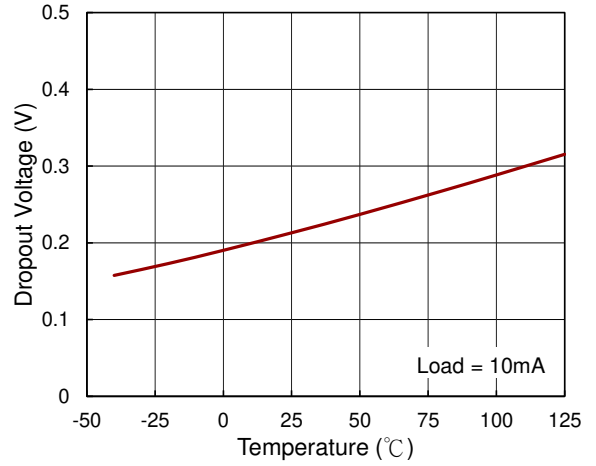

Current Limit vs. Temperature

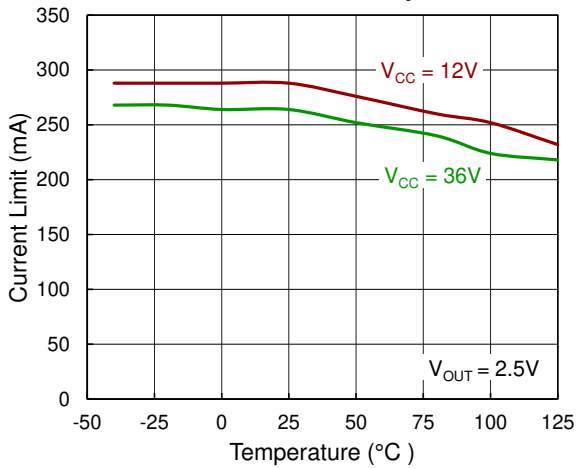

PSRR vs. Frequency

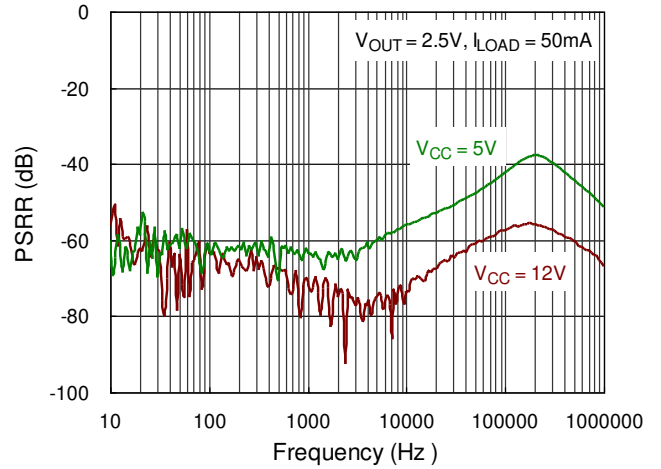

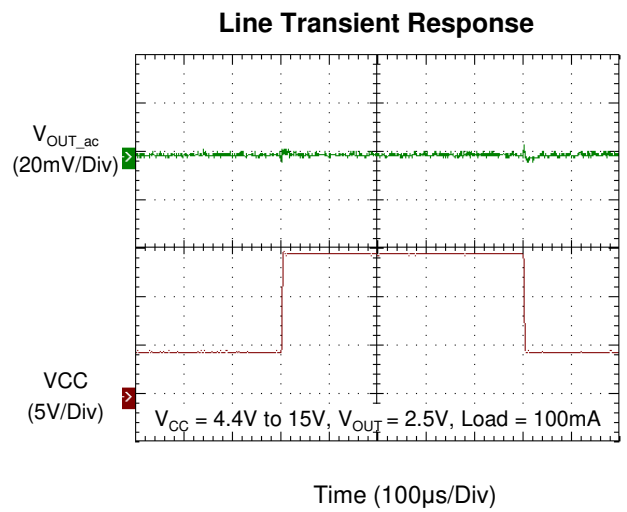
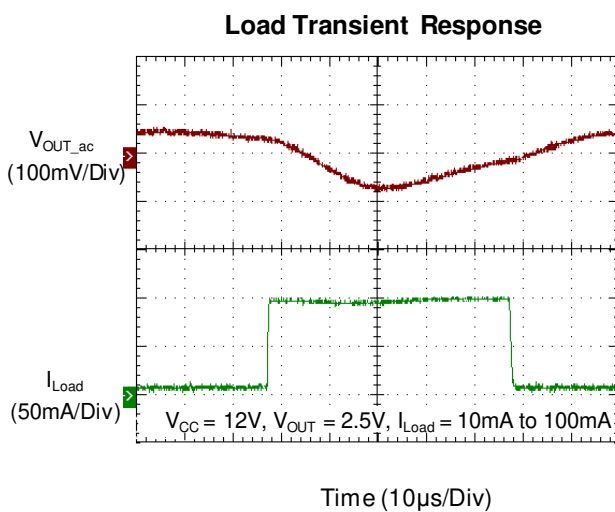
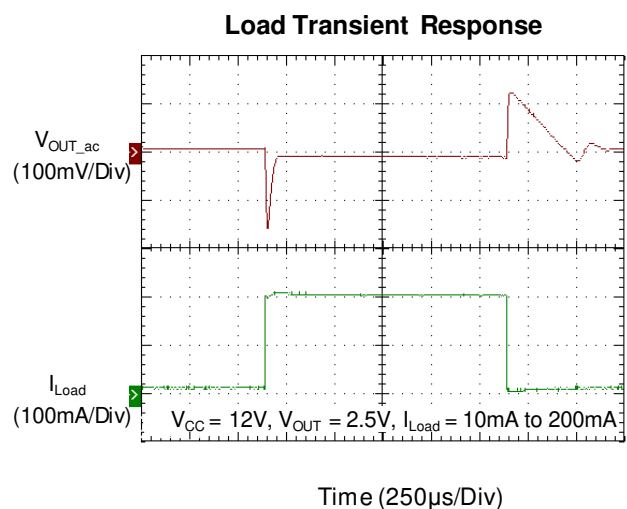
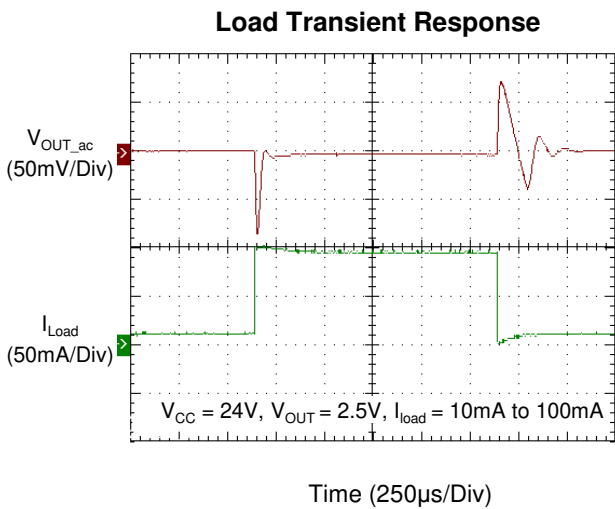
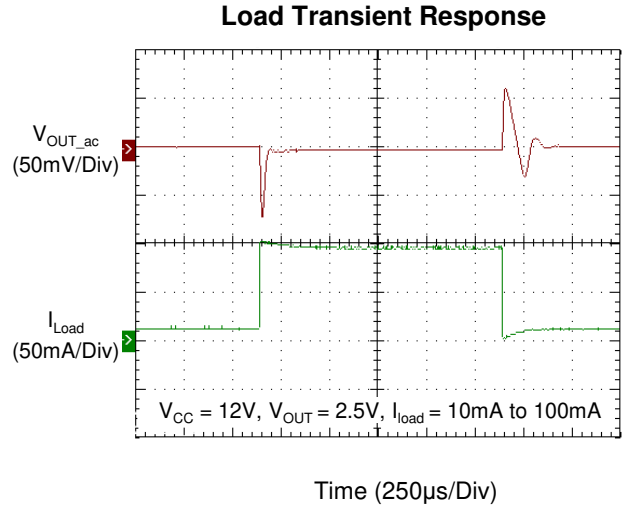
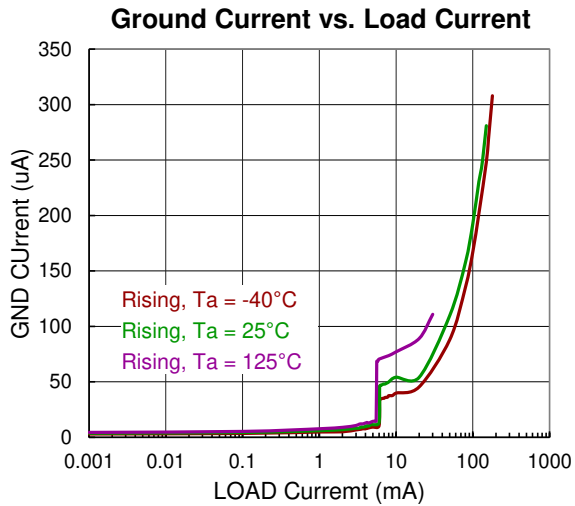

Line Transient Response

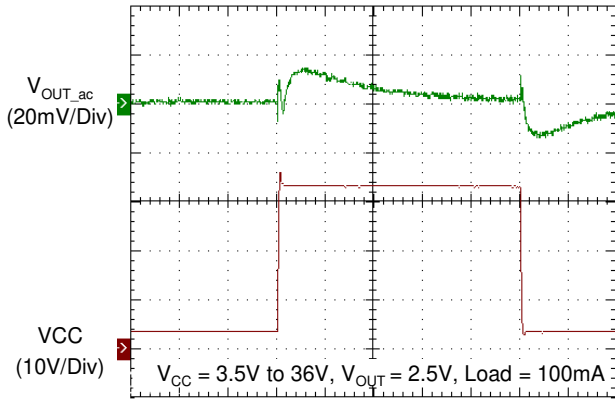

Time (100 $\mu$ s/Div)

Power On from EN

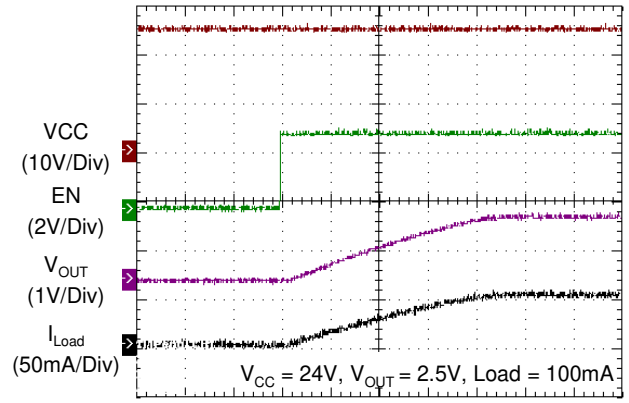

Time (25 $\mu$ s/Div)

Power Off from EN

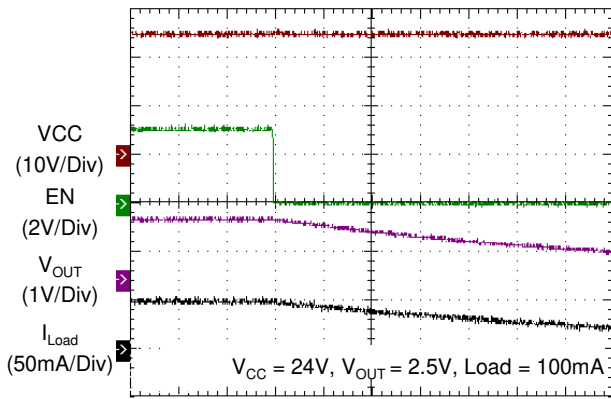

Time (25 $\mu$ s/Div)

## Application Information

### Thermal Considerations

For continuous operation, do not exceed absolute maximum junction temperature. The maximum power dissipation depends on the thermal resistance of the IC package, PCB layout, rate of surrounding airflow, and difference between junction and ambient temperature. The maximum power dissipation can be calculated by the following formula :

$$P_{D(MAX)} = (T_{J(MAX)} - T_A) / \theta_{JA}$$

where  $T_{J(MAX)}$  is the maximum junction temperature,  $T_A$  is the ambient temperature, and  $\theta_{JA}$  is the junction to ambient thermal resistance.

For recommended operating condition specifications, the maximum junction temperature is 125°C. The junction to ambient thermal resistance,  $\theta_{JA}$ , is layout dependent. For SOP-8 (Exposed Pad) packages, the thermal resistance,  $\theta_{JA}$ , is 30.6°C/W on a standard JEDEC 51-7 four-layer thermal test board. For SOT-23-5 package, the thermal resistance,  $\theta_{JA}$ , is 218.1°C/W on a standard JEDEC 51-7 four-layer thermal test board. For SOT-89-5 package, the thermal resistance,  $\theta_{JA}$ , is 113.9°C/W on a standard JEDEC 51-7 four-layer thermal test board. For UDFN-6L 1.6x1.6 package, the thermal resistance,  $\theta_{JA}$ , is 46.5°C/W on a standard JEDEC 51-7 four-layer thermal test board. The maximum power dissipation at  $T_A = 25^\circ\text{C}$  can be calculated by the following formula :

$$P_{D(MAX)} = (125^\circ\text{C} - 25^\circ\text{C}) / (30.6^\circ\text{C/W}) = 3.2679\text{W for SOP-8 (Exposed Pad) package}$$

$$P_{D(MAX)} = (125^\circ\text{C} - 25^\circ\text{C}) / (218.1^\circ\text{C/W}) = 0.4585\text{W for SOT-23-5 package}$$

$$P_{D(MAX)} = (125^\circ\text{C} - 25^\circ\text{C}) / (113.9^\circ\text{C/W}) = 0.8779\text{W for SOT-89-5 package}$$

$$P_{D(MAX)} = (125^\circ\text{C} - 25^\circ\text{C}) / (46.5^\circ\text{C/W}) = 2.15\text{W for UDFN-6L 1.6x1.6 package}$$

The maximum power dissipation depends on the operating ambient temperature for fixed  $T_{J(MAX)}$  and thermal resistance,  $\theta_{JA}$ . The derating curve in Figure 1 allows the designer to see the effect of rising ambient temperature on the maximum power dissipation

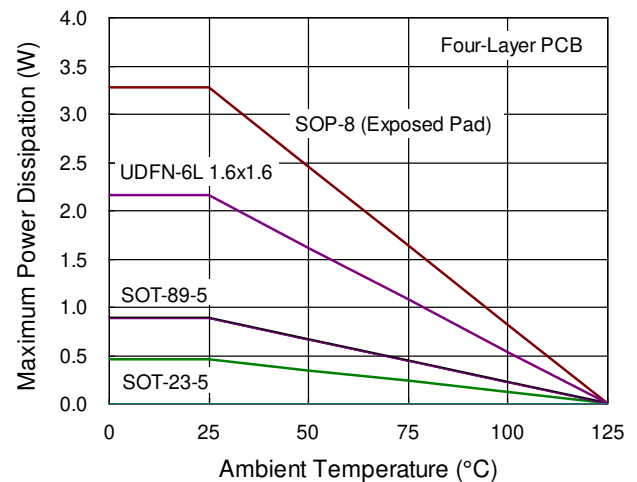
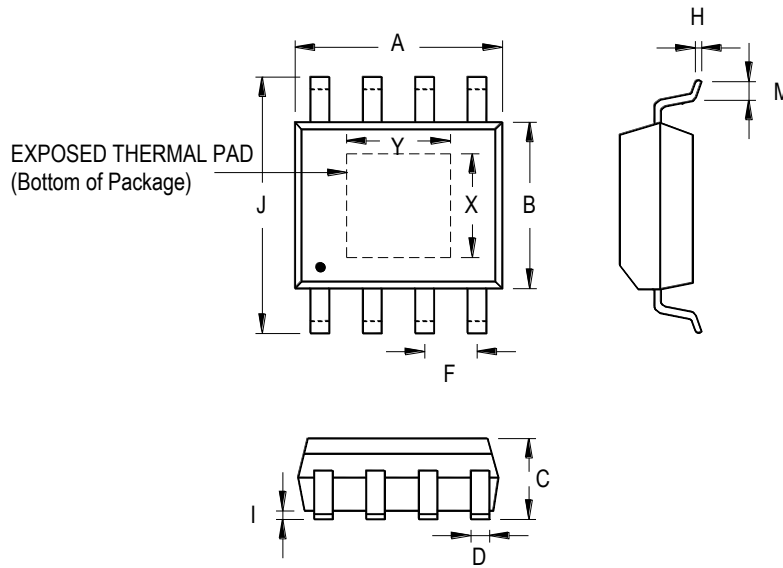

Figure 1. Derating Curve of Maximum Power Dissipation

Outline Dimension



Symbol	Dimensions In Millimeters		Dimensions In Inches		
	Min	Max	Min	Max	
A	4.801	5.004	0.189	0.197	
B	3.810	4.000	0.150	0.157	
C	1.346	1.753	0.053	0.069	
D	0.330	0.510	0.013	0.020	
F	1.194	1.346	0.047	0.053	
H	0.170	0.254	0.007	0.010	
I	0.000	0.152	0.000	0.006	
J	5.791	6.200	0.228	0.244	
M	0.406	1.270	0.016	0.050	
Option 1	X	2.000	2.300	0.079	0.091
	Y	2.000	2.300	0.079	0.091
Option 2	X	2.100	2.500	0.083	0.098
	Y	3.000	3.500	0.118	0.138

8-Lead SOP (Exposed Pad) Plastic Package

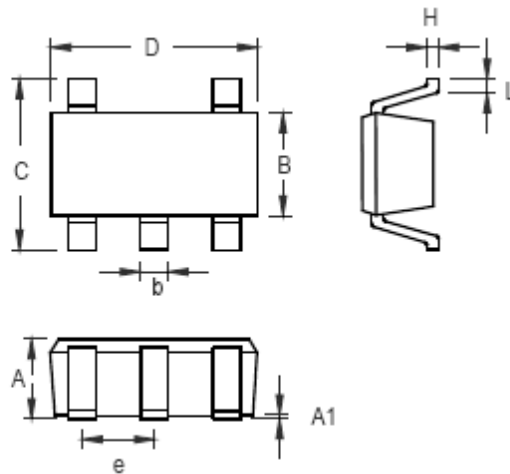

Symbol	Dimensions In Millimeters		Dimensions In Inches	
	Min	Max	Min	Max
A	0.889	1.295	0.035	0.051
A1	0.000	0.152	0.000	0.006
B	1.397	1.803	0.055	0.071
b	0.356	0.559	0.014	0.022
C	2.591	2.997	0.102	0.118
D	2.692	3.099	0.106	0.122
e	0.838	1.041	0.033	0.041
H	0.080	0.254	0.003	0.010
L	0.300	0.610	0.012	0.024

**SOT-23-5 Surface Mount Package**

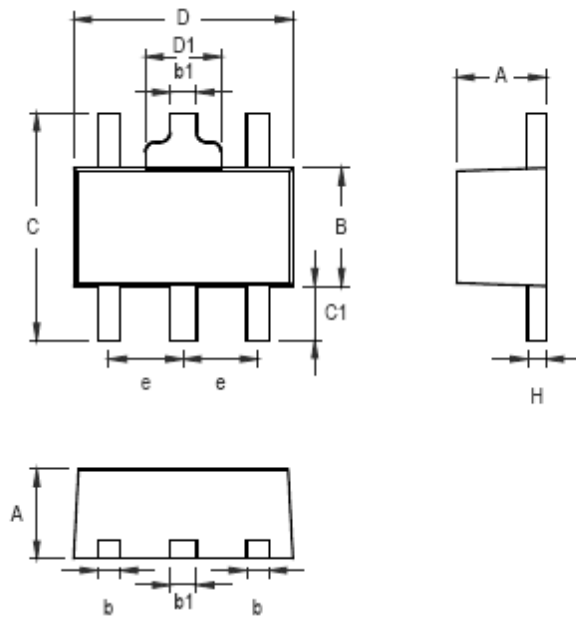

Symbol	Dimensions In Millimeters		Dimensions In Inches	
	Min	Max	Min	Max
A	1.400	1.600	0.055	0.063
b	0.360	0.508	0.014	0.020
B	2.400	2.600	0.094	0.102
b1	0.406	0.533	0.016	0.021
C	3.937	4.250	0.155	0.167
C1	0.800	1.194	0.031	0.047
D	4.400	4.600	0.173	0.181
D1	1.397	1.700	0.055	0.067
e	1.400	1.600	0.055	0.063
H	0.356	0.430	0.014	0.017

**5-Lead SOT-89 Surface Mount Package**

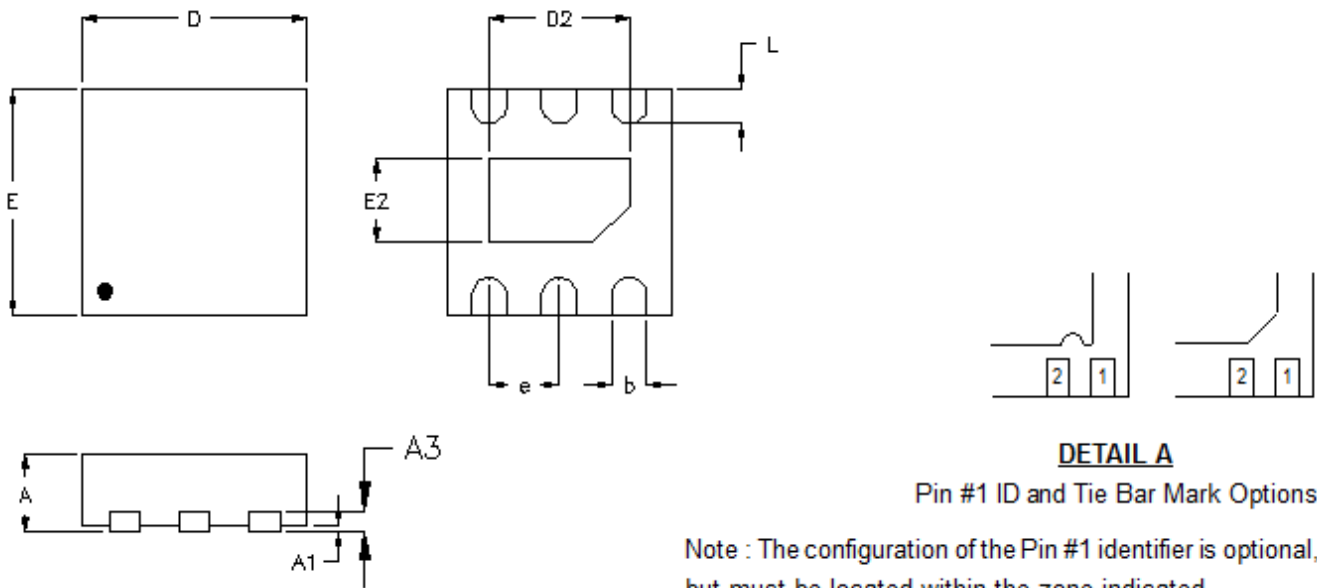

Symbol	Dimensions In Millimeters		Dimensions In Inches	
	Min.	Max.	Min.	Max.
A	0.500	0.600	0.020	0.024
A1	0.000	0.050	0.000	0.002
A3	0.100	0.175	0.004	0.007
b	0.200	0.300	0.008	0.012
D	1.500	1.700	0.059	0.067
D2	0.950	1.050	0.037	0.041
E	1.500	1.700	0.059	0.067
E2	0.550	0.650	0.022	0.026
e	0.500		0.020	
L	0.200	0.300	0.008	0.012

**U-Type 6L DFN 1.6x1.6 Package**

**Richtek Technology Corporation**

14F, No. 8, Tai Yuen 1<sup>st</sup> Street, Chupei City  
 Hsinchu, Taiwan, R.O.C.  
 Tel: (8863)5526789

Richtek products are sold by description only. Customers should obtain the latest relevant information and data sheets before placing orders and should verify that such information is current and complete. Richtek cannot assume responsibility for use of any circuitry other than circuitry entirely embodied in a Richtek product. Information furnished by Richtek is believed to be accurate and reliable. However, no responsibility is assumed by Richtek or its subsidiaries for its use; nor for any infringements of patents or other rights of third parties which may result from its use. No license is granted by implication or otherwise under any patent or patent rights of Richtek or its subsidiaries.

Copyright © 2017 Richtek Technology Corporation. All rights reserved. **RICHTEK** is a registered trademark of Richtek Technology Corporation.