



Chipsmall Limited consists of a professional team with an average of over 10 year of expertise in the distribution of electronic components. Based in Hongkong, we have already established firm and mutual-benefit business relationships with customers from,Europe,America and south Asia,supplying obsolete and hard-to-find components to meet their specific needs.

With the principle of “Quality Parts,Customers Priority,Honest Operation,and Considerate Service”,our business mainly focus on the distribution of electronic components. Line cards we deal with include Microchip,ALPS,ROHM,Xilinx,Pulse,ON,Everlight and Freescale. Main products comprise IC,Modules,Potentiometer,IC Socket,Relay,Connector.Our parts cover such applications as commercial,industrial, and automotives areas.

We are looking forward to setting up business relationship with you and hope to provide you with the best service and solution. Let us make a better world for our industry!



## Contact us

Tel: +86-755-8981 8866 Fax: +86-755-8427 6832

Email & Skype: info@chipsmall.com Web: www.chipsmall.com

Address: A1208, Overseas Decoration Building, #122 Zhenhua RD., Futian, Shenzhen, China



# 5V/12V Synchronous Buck PWM DC/DC and Linear Power Controller

## General Description

The RT9218 is a dual output with one synchronous buck PWM and one linear controller. The part is proposed to generate logic-supply voltages for PC based systems. The high-performance device includes internal soft-start, frequency-compensation networks, power good signaling with specific sequence, and it comes all of the logic control, output adjustment, power monitoring and protection functions into a small footprint package. The part is operated at fixed 300kHz frequency providing an optimum compromise between efficiency, external component size, and cost. The linear controller is implemented to drive an external MOSFET for regulation and it's adjustable by setting external resistors. Moreover the specific internal PGOOD sequence and indicator is also implemented to conform to Intel® new platform requirement on FSB\_VTT power plane. An adjustable over-current protection (OCP) is proposed to monitor the voltage drop across the  $R_{DS(ON)}$  of the lower MOSFET for synchronous buck PWM DC/DC controller.

## Ordering Information

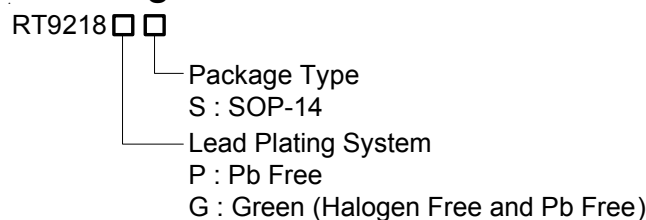

Note :

Richtek products are :

- ▶ RoHS compliant and compatible with the current requirements of IPC/JEDEC J-STD-020.
- ▶ Suitable for use in SnPb or Pb-free soldering processes.

## Features

- Operating with 5V or 12V Supply Voltage
- Drives All Low Cost N-MOSFETs
- Voltage Mode PWM Control
- 300kHz Fixed Frequency Oscillator
- Fast Transient Response :
  - ▶ High-Speed GM Amplifier
  - ▶ Full 0 to 100% Duty Ratio
- Internal Soft-Start
- Power Good Indicator
- Adaptive Non-Overlapping Gate Driver
- Over Current Fault Monitor on MOSFET, No Current Sense Resistor Required
- Specific Power Good Indicator for Intel® Grantsdale FSB\_VTT Power Sequence
- RoHS Compliant and 100% Lead (Pb)-Free

## Applications

- Graphic Card
- Motherboard, Desktop Servers
- IA Equipments
- Telecomm Equipments
- High Power DC-DC Regulators

## Pin Configurations

(TOP VIEW)

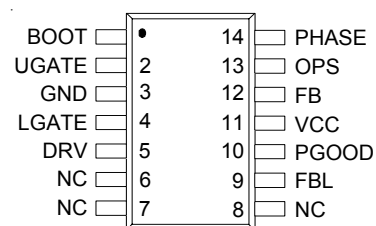

SOP-14

Typical Application Circuit

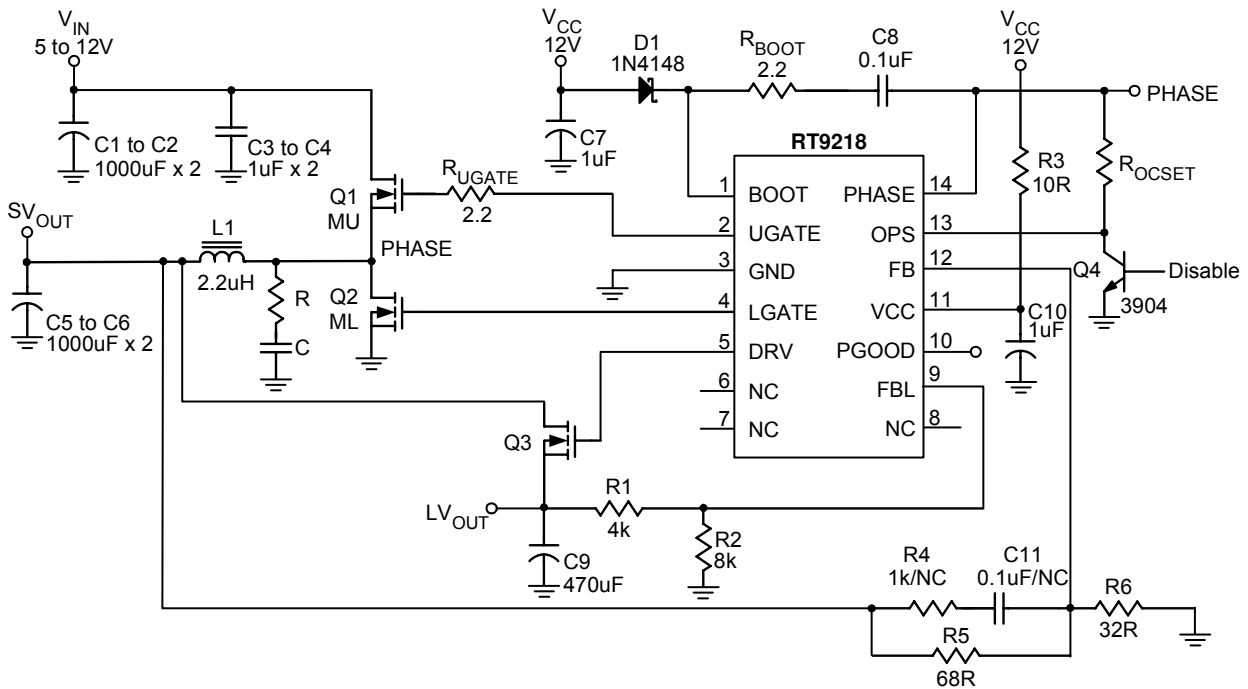

$$SV_{OUT} = V_{REF} \times \left(1 + \frac{R_5}{R_6}\right)$$

$$LV_{OUT} = V_{REF} \times \left(1 + \frac{R_1}{R_2}\right)$$

\$V\_{REF}\$ : Internal reference voltage  
(0.8V ± 2%)

## Functional Pin Description

### UGATE (Pin 2)

Upper gate driver output. Connect to gate of the high-side power N-MOSFET. This pin is monitored by the adaptive shoot-through protection circuitry to determine when the upper MOSFET has turned off.

### BOOT (Pin 1)

Bootstrap supply pin for the upper gate driver. Connect the bootstrap capacitor between BOOT pin and the PHASE pin. The bootstrap capacitor provides the charge to turn on the upper MOSFET.

### PHASE (Pin 14)

Connect this pin to the source of the upper MOSFET and the drain of the lower MOSFET.

### OPS (OCSET, POR and Shut-Down) (Pin 13)

This pin provides multi-function of the over-current setting, UGATE turn-on POR sensing, and shut-down features. Connecting a resistor ( $R_{OCSET}$ ) between OPS and PHASE pins sets the over-current trip point.

Pulling the pin to ground resets the device and all external MOSFETs are turned off allowing the output voltage power rails to float.

This pin is also used to detect  $V_{IN}$  in power on stage and issues an internal POR signal.

### LGATE (Pin 4)

Lower gate drive output. Connect to gate of the low-side power N-MOSFET. This pin is monitored by the adaptive shoot-through protection circuitry to determine when the lower MOSFET has turned off.

### FB (Pin 12)

Switcher feedback voltage. This pin is the inverting input of the error amplifier. FB senses the switcher output through an external resistor divider network.

### VCC (Pin 11)

Connect this pin to a well-decoupled 5V or 12V bias supply. It is also the positive supply for the lower gate driver, LGATE.

### GND (Pin 3)

Both signal and power ground for the IC. All voltage levels are measured with respect to this pin. Ties the pin directly to the low-side MOSFET source and ground plane with the lowest impedance.

### DRV (Pin 5)

Connect this pin to the base/gate of an external transistor/MOSFET. This pin provides the drive for the linear regulator's pass transistor/MOSFET.

### FBL (Pin 9)

Linear regulator feedback voltage. This pin is the inverting input of the error amplifier and protection monitor. Connect this pin to the external resistor divider network of the linear regulator.

### PGOOD (Pin 10)

PGOOD is an open-drain output used to indicate that the regulator is within normal operating voltage ranges and it's implemented with a specific sequence as following chart.

### NC (Pin 6,7,8)

No internal connection.

Function Block Diagram

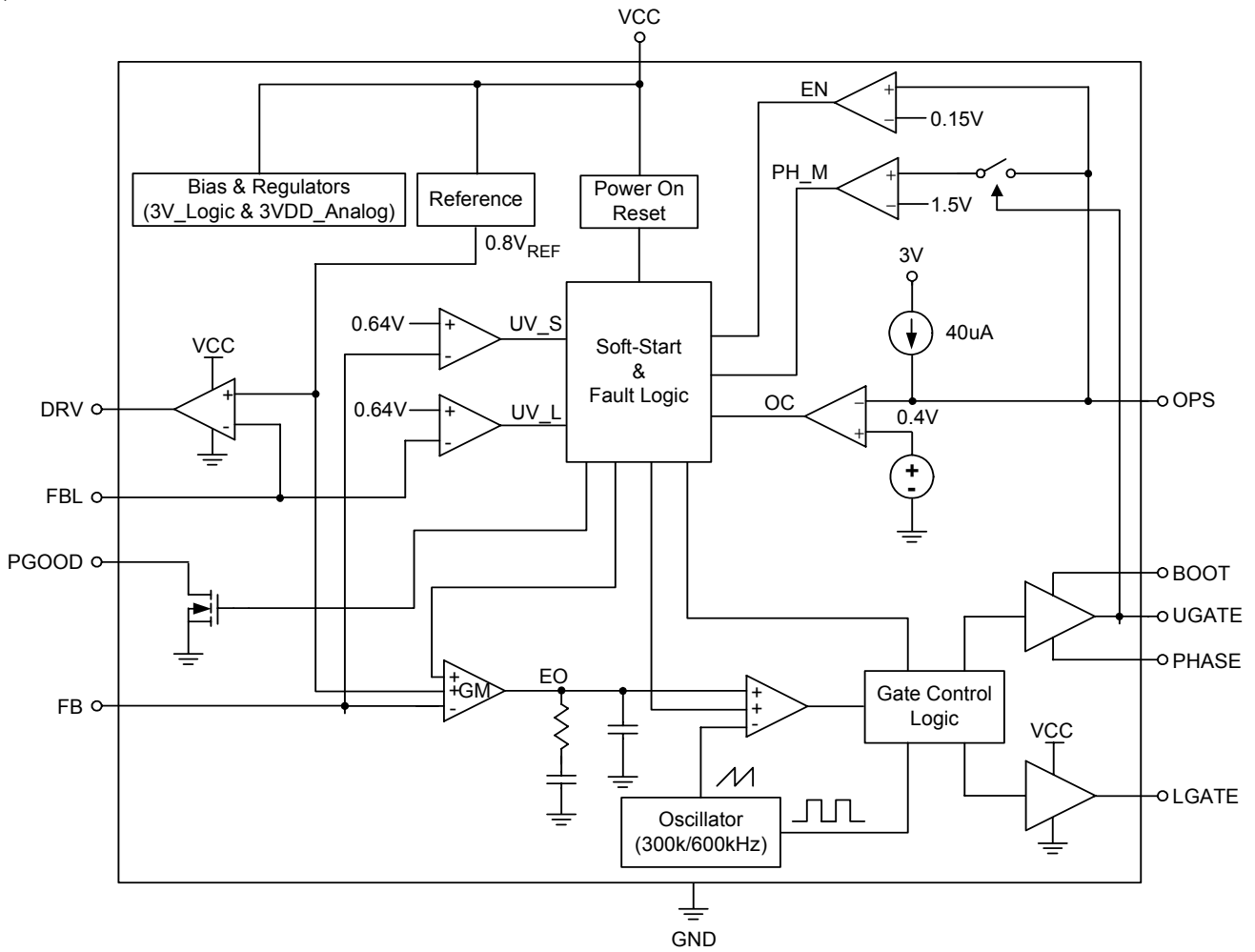

Timing Diagram

Specific Power Sequence for LDO

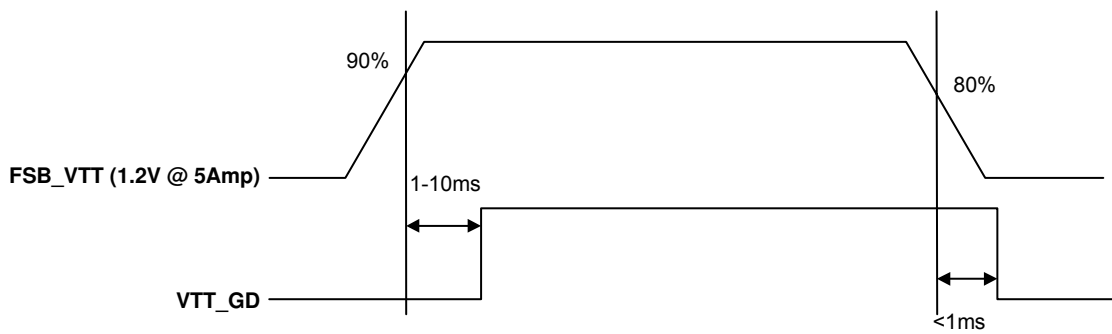

**Absolute Maximum Ratings** (Note 1)

- Supply Voltage,  $V_{CC}$  ----- 16V
- BOOT,  $V_{BOOT} - V_{PHASE}$  ----- 16V
- PHASE to GND
  - DC ----- -5V to 15V
  - < 200ns ----- -10V to 30V
- BOOT to PHASE ----- 15V
- BOOT to GND
  - DC ----- -0.3V to  $V_{CC}+15V$
  - < 200ns ----- -0.3V to 42V
- UGATE -----  $V_{PHASE} - 0.3V$  to  $V_{BOOT} + 0.3V$
- LGATE ----- GND - 0.3V to  $V_{VCC} + 0.3V$
- Input, Output or I/O Voltage ----- GND - 0.3V to 7V
- Package Thermal Resistance (Note 2)
  - SOP-14,  $\theta_{JA}$  ----- 127.67°C/W
- Junction Temperature ----- 150°C
- Lead Temperature (Soldering, 10 sec.) ----- 260°C
- Storage Temperature Range ----- -40°C to 150°C
- ESD Susceptibility (Note 3)
  - HBM (Human Body Mode) ----- 2kV
  - MM (Machine Mode) ----- 200V

**Recommended Operating Conditions** (Note 4)

- Supply Voltage,  $V_{CC}$  -----  $5V \pm 5\%$ ,  $12V \pm 10\%$
- Junction Temperature Range ----- -40°C to 125°C
- Ambient Temperature Range ----- -40°C to 85°C

**Electrical Characteristics**

( $V_{CC} = 5V/12V$ ,  $T_A = 25^\circ C$ , unless otherwise specified)

Parameter	Symbol	Test Conditions	Min	Typ	Max	Unit
<b><math>V_{CC}</math> Supply Current</b>						
Nominal Supply Current	$I_{CC}$	UGATE and LGATE Open	--	6	15	mA
<b>Power-On Reset</b>						
POR Threshold	$V_{CCRTH}$	$V_{CC}$ Rising	--	4.1	4.5	V
Hysteresis	$V_{CCCHYS}$		0.35	0.5	--	V
<b>Switcher Reference</b>						
Reference Voltage	$V_{REF}$	$V_{CC} = 12V$	0.784	0.8	0.816	V
<b>Oscillator</b>						
Free Running Frequency	$f_{OSC}$	$V_{CC} = 12V$	250	300	350	kHz
Ramp Amplitude	$\Delta V_{OSC}$		--	1.5	--	$V_{P-P}$

*To be continued*

Parameter	Symbol	Test Conditions	Min	Typ	Max	Unit
<b>Error Amplifier (GM)</b>						
E/A Transconductance	$g_m$		--	0.2	--	ms
Open Loop DC Gain	$A_O$		--	90	--	dB
<b>Linear Regulator</b>						
DRV Driver Source	$I_{DS}$	$V_{DRV} = 6V$	--	1.4	--	mA
Reference Voltage	$V_{REFREG}$	$V_{CC} = 12V$	0.784	0.8	0.816	V
<b>PWM Controller Gate Drivers (<math>V_{CC} = 12V</math>)</b>						
Upper Gate Source	$I_{UGATE}$	$V_{BOOT} - V_{PHASE} = 12V$ $V_{UGATE} - V_{PHASE} = 6V$	0.6	1	--	A
Upper Gate Sink	$R_{UGATE}$	$V_{BOOT} - V_{PHASE} = 12V$ $V_{UGATE} - V_{PHASE} = 1V$	--	4	--	$\Omega$
Lower Gate Source	$I_{LGATE}$	$V_{CC} = 12V, V_{LGATE} = 6V$	0.6	1	--	A
Lower Gate Sink	$R_{LGATE}$	$V_{CC} = 12V, V_{LGATE} = 1V$	--	3	4	$\Omega$
Dead Time	$T_{DT}$		--	--	100	ns
<b>Protection</b>						
FB Under-Voltage Trip	$\Delta F_{BUVT}$	FB Falling	70	75	80	%
FBL Under-Voltage Trip	$\Delta F_{BLUVT}$	FB and FBL Falling	70	75	80	%
OC Current Source	$I_{OC}$	$V_{PHASE} = 0V$	--	40	--	$\mu A$
Soft-Start Interval	$T_{SS}$		--	3.5	--	ms
<b>Power Good</b>						
Power Good Rising Threshold		$V_{CC} = 12V$	--	90	--	%
Power Good Hysteresis		$V_{CC} = 12V$	--	10	--	%
PG Sink Capability		$V_{CC} = 12V, 1mA$	--	0.2	0.4	V
Power Good Rising Delay		$V_{CC} = 12V$	1	3	10	ms
Power Good Falling Delay		$V_{CC} = 12V$	--	15	--	$\mu s$

**Note 1.** Stresses listed as the above "Absolute Maximum Ratings" may cause permanent damage to the device. These are for stress ratings. Functional operation of the device at these or any other conditions beyond those indicated in the operational sections of the specifications is not implied. Exposure to absolute maximum rating conditions for extended periods may remain possibility to affect device reliability.

**Note 2.**  $\theta_{JA}$  is measured in the natural convection at  $T_A = 25^\circ C$  on a low effective thermal conductivity test board of JEDEC 51-3 thermal measurement standard.

**Note 3.** Devices are ESD sensitive. Handling precaution recommended.

**Note 4.** The device is not guaranteed to function outside its operating conditions.

**Typical Operating Characteristics**

( $V_{OUT} = 2.5V$ , unless otherwise specified)

**Efficiency vs. Output Current**

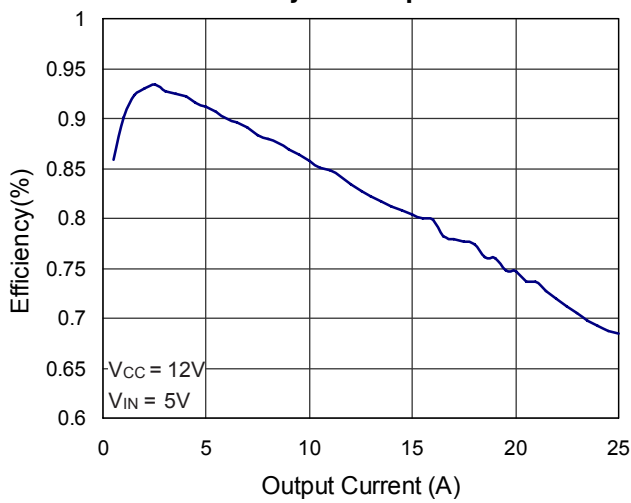

**Efficiency vs. Output Current**

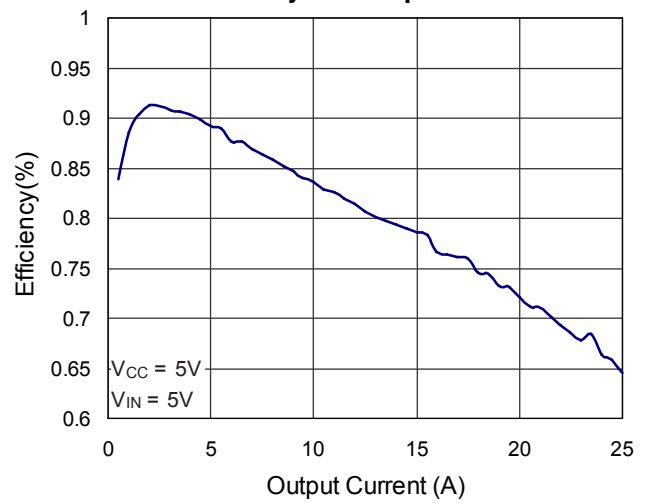

**Reference Voltage vs. Temperature**

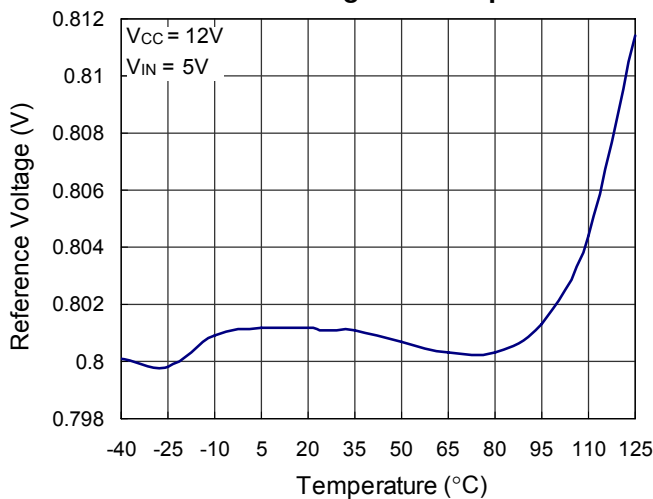

**Frequency vs. Temperature**

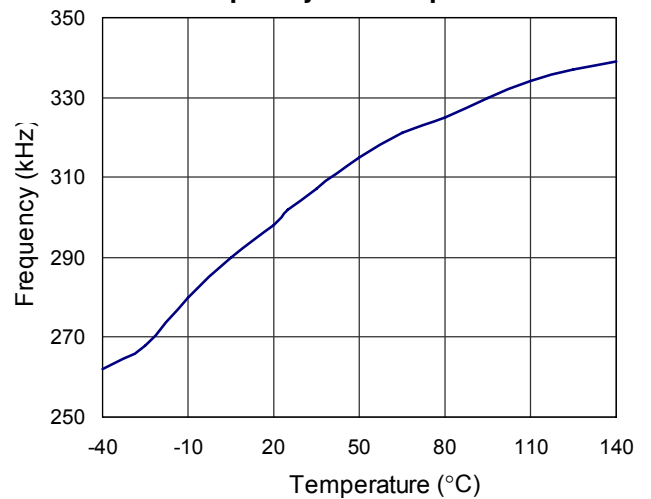

**POR vs. Temperature**

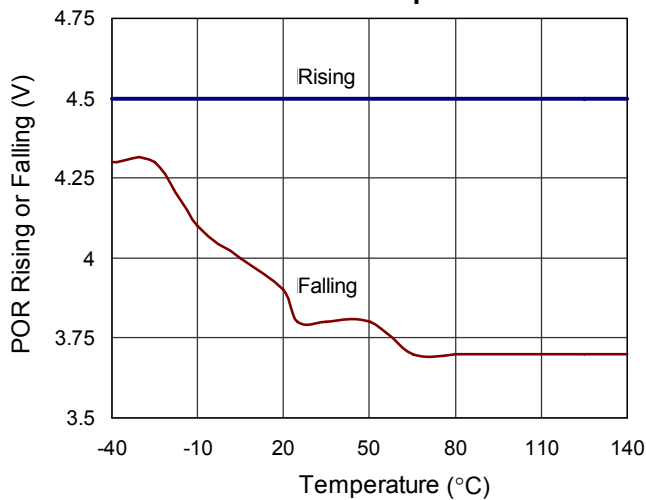

**OCP**

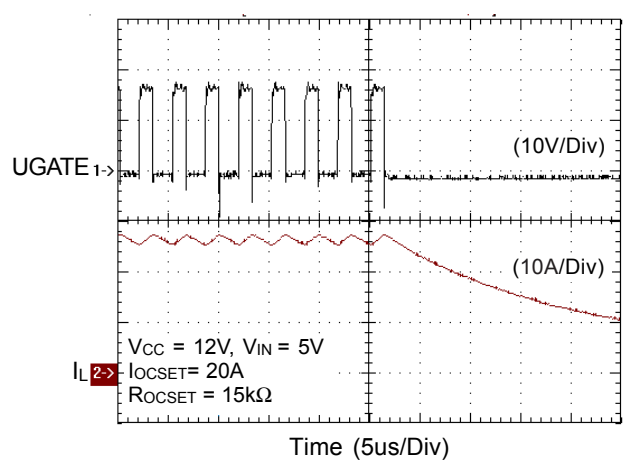



V<sub>CC</sub> Switching

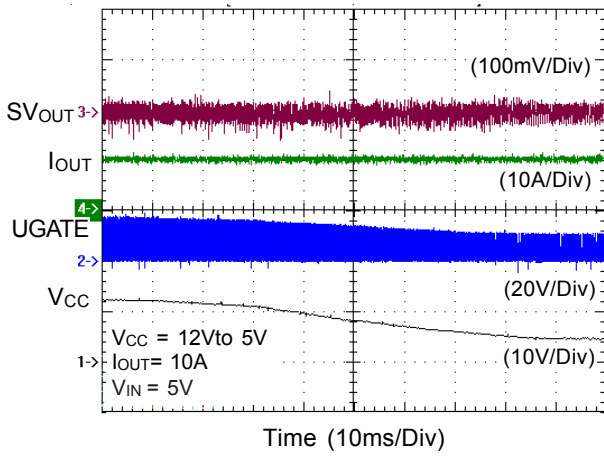

V<sub>CC</sub> Switching

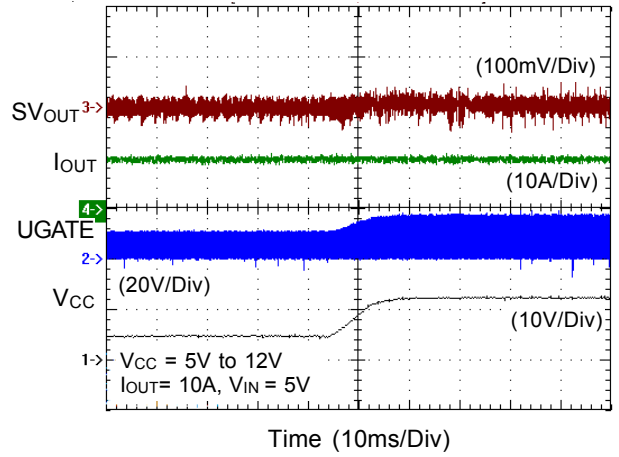

Power On

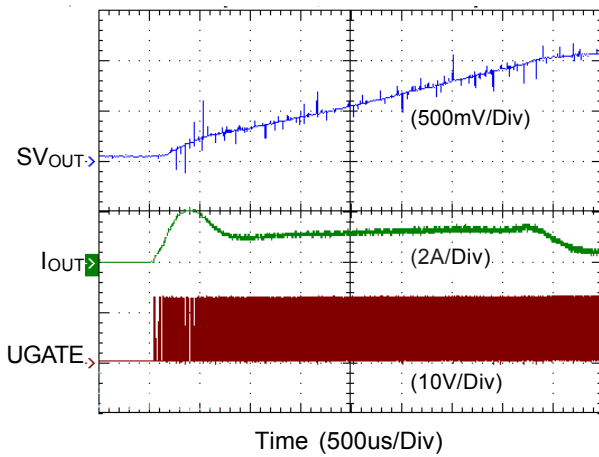

Power Off

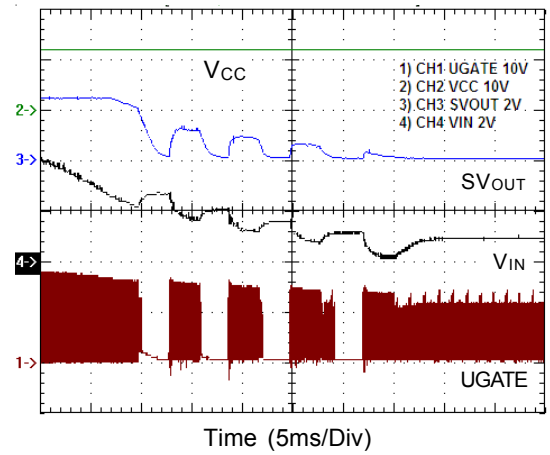

Dead Time (Rising)

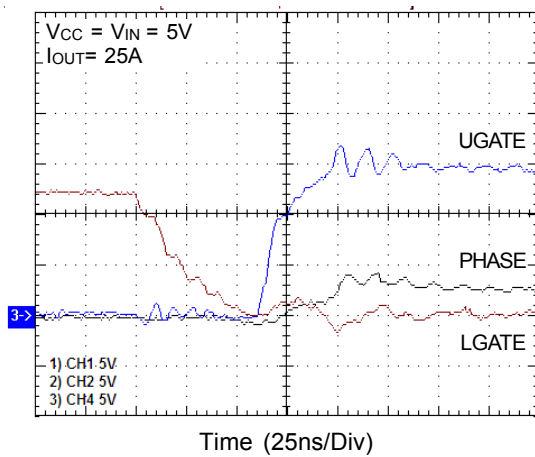

Dead Time (Falling)

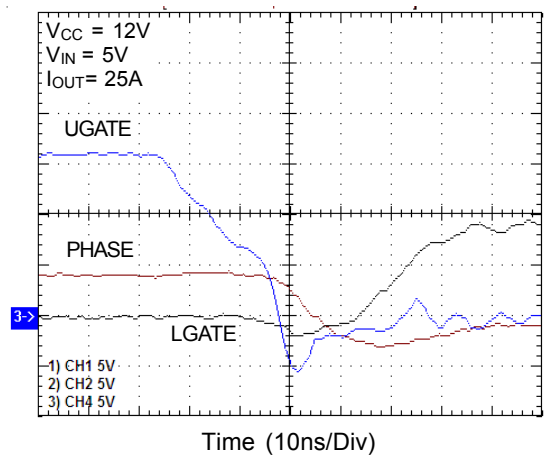

**Transient Response (Rising)**

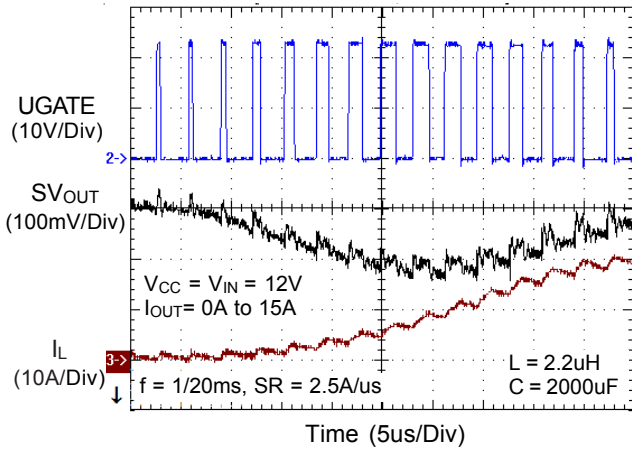

**Transient Response (Falling)**

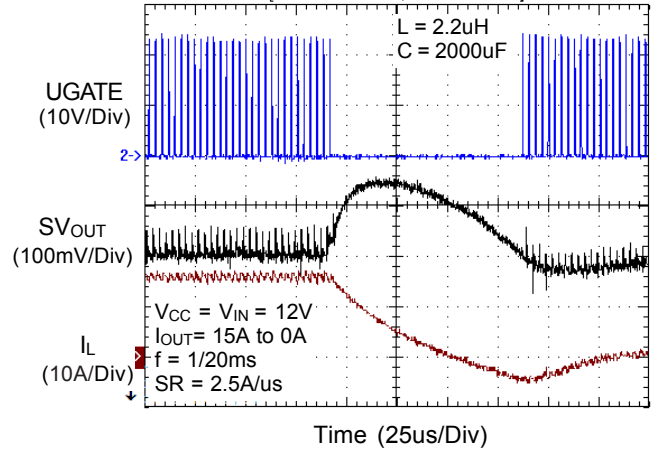

**Soft Start & PGOOD**

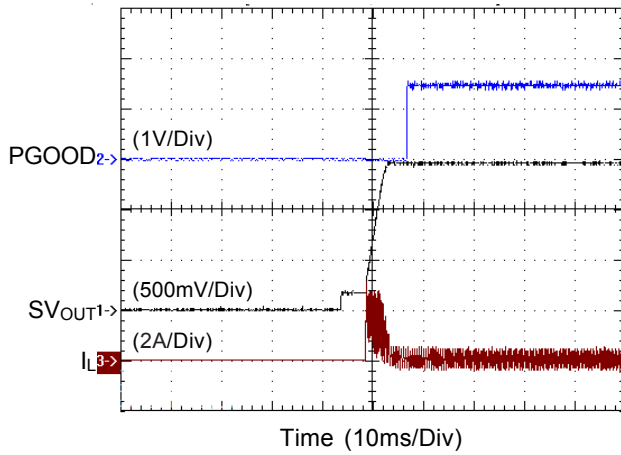

### Application Information

#### Inductor Selection

The selection of output inductor is based on the considerations of efficiency, output power and operating frequency. Low inductance value has smaller size, but results in low efficiency, large ripple current and high output ripple voltage. Generally, an inductor that limits the ripple current ( $\Delta I_L$ ) between 20% and 50% of output current is appropriate. Figure 1 shows the typical topology of synchronous step-down converter and its related waveforms.

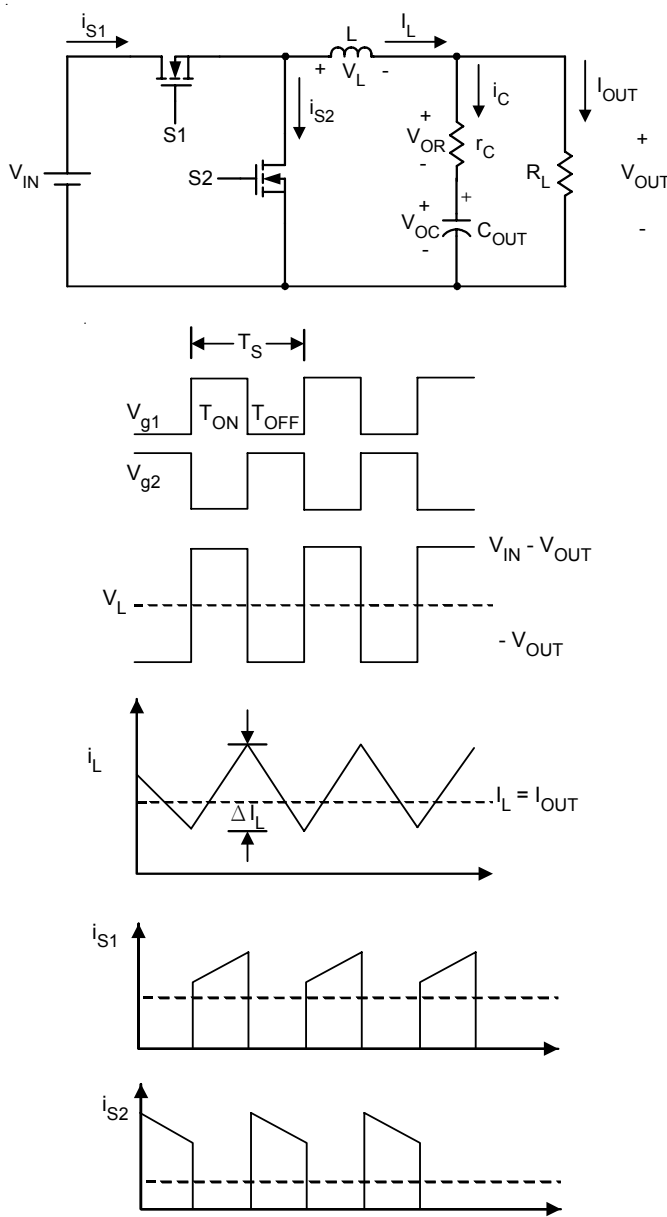

Figure 1. The waveforms of synchronous step-down converter

According to Figure 1 the ripple current of inductor can be calculated as follows :

$$V_{IN} - V_{OUT} = L \frac{\Delta I_L}{\Delta t}; \quad \Delta t = \frac{D}{f_s}; \quad D = \frac{V_{OUT}}{V_{IN}}$$

$$L = (V_{IN} - V_{OUT}) \times \frac{V_{OUT}}{V_{IN} \times f_s \times \Delta I_L} \tag{1}$$

Where :

$V_{IN}$  = Maximum input voltage

$V_{OUT}$  = Output Voltage

$\Delta t$  = S1 turn on time

$\Delta I_L$  = Inductor current ripple

$f_s$  = Switching frequency

$D$  = Duty Cycle

$r_C$  = Equivalent series resistor of output capacitor

#### Output Capacitor

The selection of output capacitor depends on the output ripple voltage requirement. Practically, the output ripple voltage is a function of both capacitance value and the equivalent series resistance (ESR)  $r_C$ . Figure 2 shows the related waveforms of output capacitor.

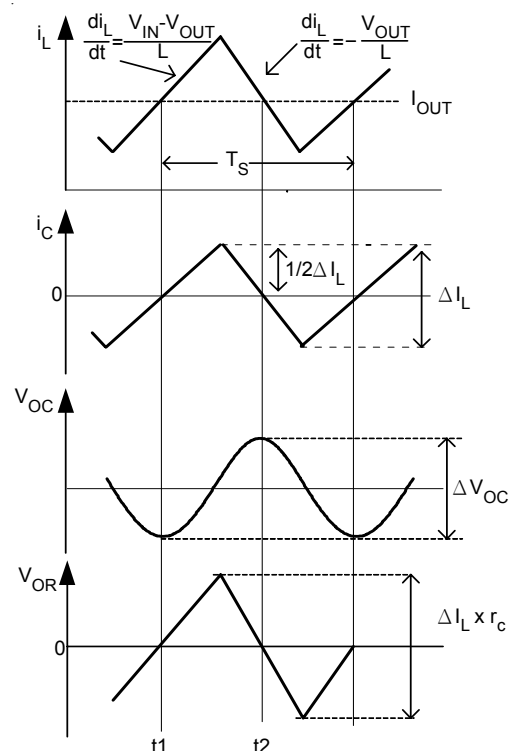

Figure 2. The related waveforms of output capacitor

The AC impedance of output capacitor at operating frequency is quite smaller than the load impedance, so the ripple current ( $\Delta I_L$ ) of the inductor current flows mainly through output capacitor. The output ripple voltage is described as :

$$\Delta V_{OUT} = \Delta V_{OR} + \Delta V_{OC} \tag{2}$$

$$\Delta V_{OUT} = \Delta I_L \times rc + \frac{1}{C_O} \int_{t1}^{t2} ic dt \tag{3}$$

$$\Delta V_{OUT} = \Delta I_L \times \Delta I_L \times rc + \frac{1}{8} \frac{V_{OUT}}{C_{OL}} (1-D) T_S^2 \tag{4}$$

where  $\Delta V_{OR}$  is caused by ESR and  $\Delta V_{OC}$  by capacitance. For electrolytic capacitor application, typically 90 to 95% of the output voltage ripple is contributed by the ESR of output capacitor. So Equation (4) could be simplified as :

$$\Delta V_{OUT} = \Delta I_L \times rc \tag{5}$$

Users could connect capacitors in parallel to get calculated ESR.

**Input Capacitor**

The selection of input capacitor is mainly based on its maximum ripple current capability. The buck converter draws pulsewise current from the input capacitor during the on time of S1 as shown in Figure 1. The RMS value of ripple current flowing through the input capacitor is described as :

$$I_{rms} = I_{OUT} \sqrt{D(1-D)} \tag{6}$$

The input capacitor must be cable of handling this ripple current. Sometime, for higher efficiency the low ESR capacitor is necessarily.

**PWM Loop Stability**

RT9218 is a voltage mode buck converter using the high gain error amplifier with transconductance (OTA, Operational Transconductance Amplifier).

The transconductance :

$$GM = \frac{dI_{OUT}}{dV_m}$$

The mid-frequency gain :

$$dV_{OUT} = dI_{OUT} Z_{OUT} = GM dV_{IN} Z_{OUT}$$

$$G = \frac{dV_{OUT}}{dV_{IN}} = GM Z_{OUT}$$

$Z_{OUT}$  is the shut impedance at the output node to ground (see Figure 3 and Figure 4),

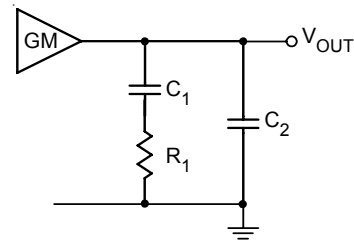

Figure 3. A Type 2 error-amplifier with shut network to ground

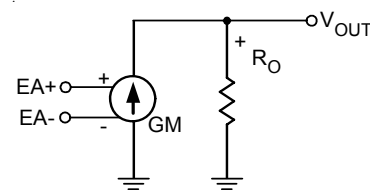

Figure 4. Equivalent circuit

Pole and Zero :

$$F_P = \frac{1}{2\pi \times R_1 C_2}; F_Z = \frac{1}{2\pi \times R_1 C_1}$$

We can see the open loop gain and the Figure 3 whole loop gain in Figure 5.

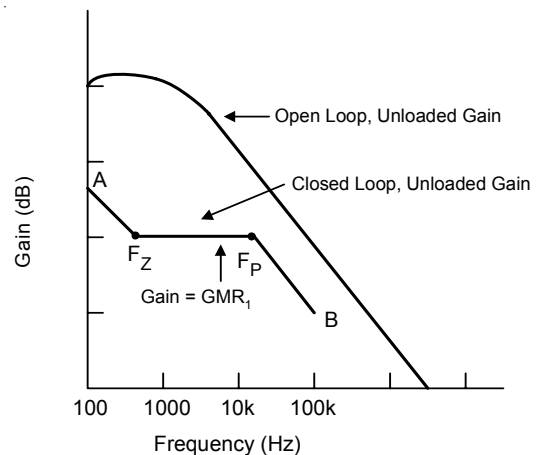

Figure 5. Gain with the Figure 2 circuit

RT9218 internal compensation loop :

$$GM = 0.2ms, R_1 = 75k\Omega, C_1 = 2.5nF, C_2 = 10pF$$

## OPS (Over Current Setting, VIN\_POR and Shutdown)

### 1.OCP

Sense the low-side MOSFET's  $R_{DS(ON)}$  to set over-current trip point.

Connecting a resistor ( $R_{OCSET}$ ) from this pin to the source of the upper MOSFET and the drain of the lower MOSFET sets the over-current trip point.  $R_{OCSET}$ , an internal  $40\mu A$  current source, and the lower MOSFET on resistance,  $R_{DS(ON)}$ , set the converter over-current trip point ( $I_{OCSET}$ ) according to the following equation :

$$I_{OCSET} = \frac{40\mu A \times R_{OCSET} - 0.4V}{R_{DS(ON)} \text{ of the lower MOSFET}}$$

OPS pin function is similar to RC charging or discharging circuit, so the over-current trip point is very sensitive to parasitic capacitance (ex. shut-down MOSFET) and the duty ratio.

Below Figures say those effect. And test conditions are  $R_{ocset} = 15k\Omega$  (over -current trip point = 20.6A), Low-side MOSFET is IR3707.

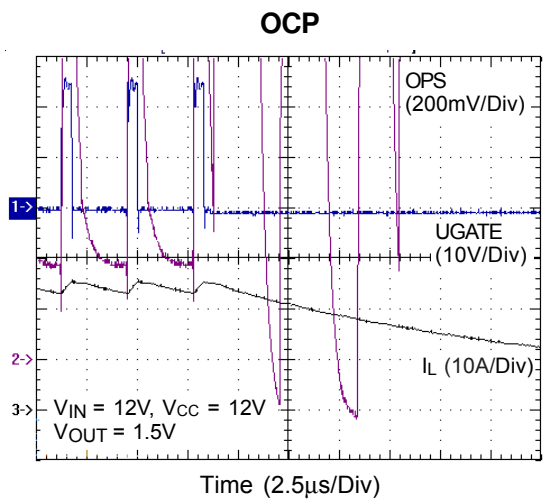
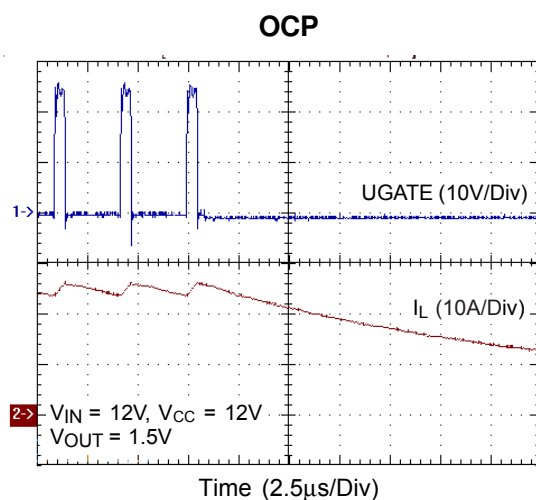
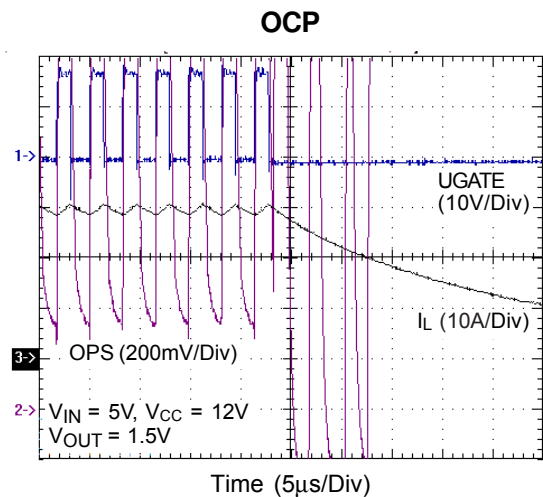
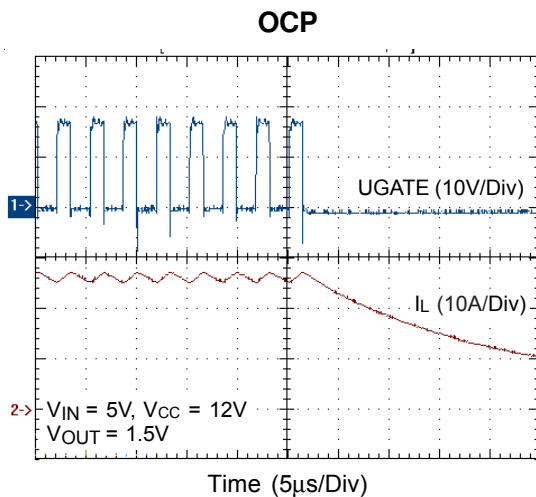

2. VIN\_POR

UGATE will continuously generate a 10kHz colck with 1% duty cycle before VIN is ready. VIN is recognized ready by detecting VOPS crossing 1.5V four times (rising & falling). ROCSET must be kept lower than 37.5kΩ for large ROCSET will keep VOPS always higher than 1.5V. Figure 6 shows the detail actions of OCP and POR. It is highly recommend-ed that ROCSET be lower than 30kΩ.

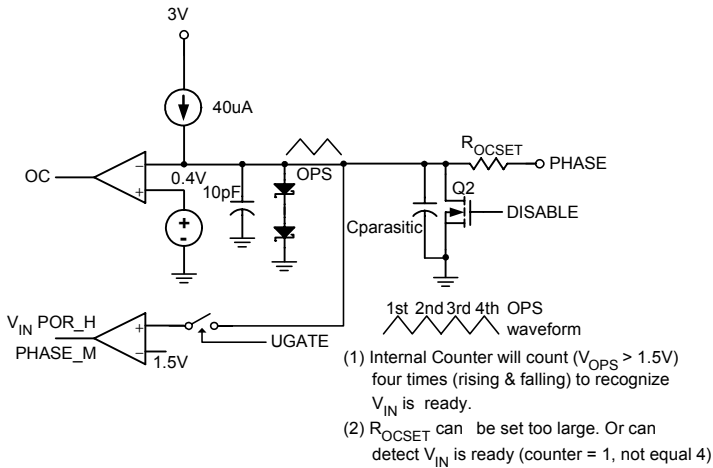

Figure 6. OCP and VIN\_POR actions

3. Shutdown

Pulling low the OPS pin by a small single transistor can shutdown the RT9218 PWM controller as shown in typical application circuit.

Soft Start

A built-in soft-start is used to prevent surge current from power supply input during power on. The soft-start voltage is controlled by an internal digital counter. It clamps the ramping of reference voltage at the input of error amplifier and the pulse-width of the output driver slowly. The typical soft-start duration is 3ms.

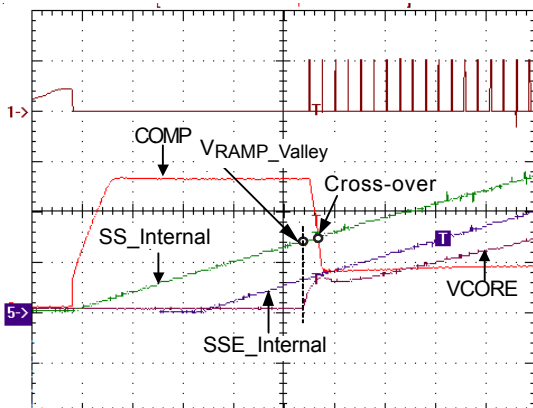

1) Mode 1 (SS < VRAMP\_valley)

Initially the COMP stays in the positive saturation. When  $SS < V_{RAMP\_Valley}$ , there is no non-inverting input available to produce duty width. So there is no PWM signal and  $V_{OUT}$  is zero.

2) Mode 2 ( $V_{RAMP\_Valley} < SS < Cross-over$ )

When  $SS > V_{RAMP\_Valley}$ , SS takes over the non-inverting input and produce the PWM signal and the increasing duty width according to its magnitude above the ramp signal. The output follows the ramp signal, SS. However while  $V_{OUT}$  increases, the difference between  $V_{OUT}$  and SSE ( $SS - V_{GS}$ ) is reduced and COMP leaves the saturation and declines. The takeover of SS lasts until it meets the COMP. During this interval, since the feedback path is broken, the converter is operated in the open loop.

3) Mode3 (Cross-over < SS <  $V_{GS} + V_{REF}$ )

When the Comp takes over the non-inverting input for PWM Amplifier and when  $SSE (SS - V_{GS}) < V_{REF}$ , the output of the converter follows the ramp input, SSE ( $SS - V_{GS}$ ). Before the crossover, the output follows SS signal. And when Comp takes over SS, the output is expected to follow SSE ( $SS - V_{GS}$ ). Therefore the deviation of  $V_{GS}$  is represented as the falling of  $V_{OUT}$  for a short while. The COMP is observed to keep its decline when it passes the cross-over, which shortens the duty width and hence the falling of  $V_{OUT}$  happens.

Since there is a feedback loop for the error amplifier, the output's response to the ramp input, SSE ( $SS - V_{GS}$ ) is lower than that in Mode 2.

4) Mode 4 ( $SS > V_{GS} + V_{REF}$ )

When  $SS > V_{GS} + V_{REF}$ , the output of the converter follows the desired  $V_{REF}$  signal and the soft start is completed now.

**Under Voltage Protection**

The voltage at FB and FBL pin is monitored and protected against UV (under voltage). The UV threshold is the FB or FBL under 75%. UV detection has 30µs triggered delay. When OC or UV\_FBL is triggered, a hiccup restart sequence will be initialized, as shown in Figure 7 Only 4 times of trigger are allowed to latch off. Hiccup is disabled during soft-start interval, but UV\_FB has some difference from OC and UV\_FBL, it will always trigger V<sub>IN</sub> power sensing after 4 times hiccup, as shown in Figure 8.

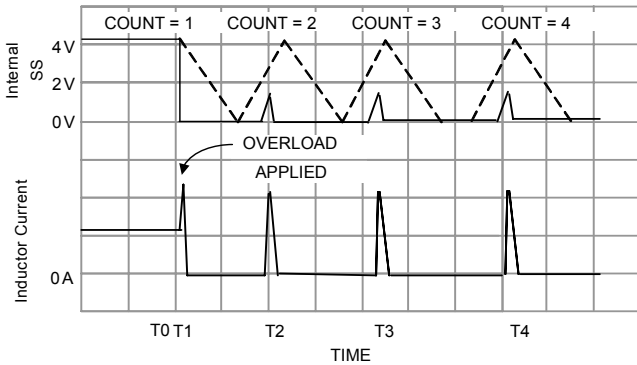

Figure 7. UV and OC trigger hiccup mode

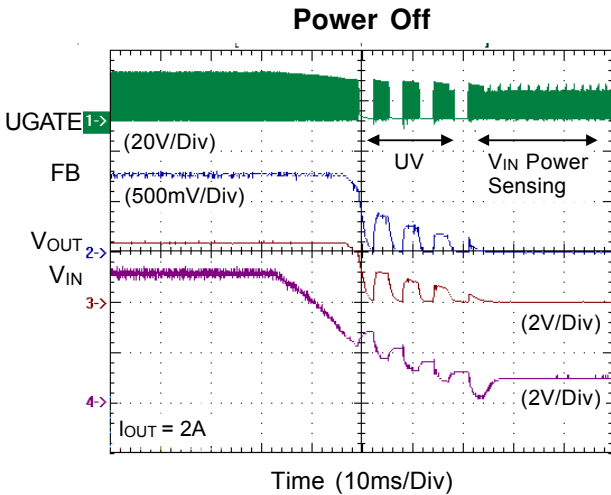

Figure 8, UV\_FB trigger V<sub>IN</sub> power sensing

**LDO Power Sequence**

In VGA field, the MOSFET of LV<sub>OUT</sub> is sourced by external voltage not by SV<sub>OUT</sub>.

This connection may trigger UV protection to shutdown RT9218, but using the typical application circuit won't have this issue. See figure 9 using OPS pin to control the power sequence.

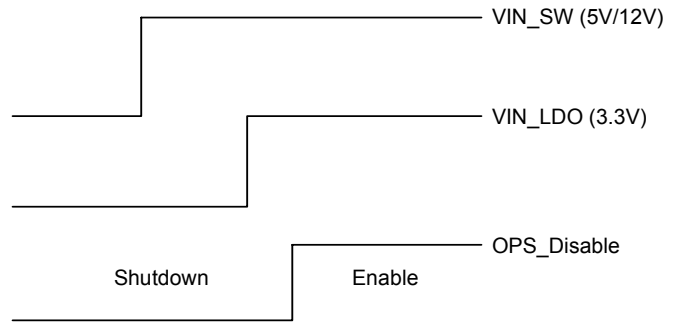

Figure 9. LDO power sequence

**PWM Layout Considerations**

MOSFETs switch very fast and efficiently. The speed with which the current transitions from one device to another causes voltage spikes across the interconnecting impedances and parasitic circuit elements. The voltage spikes can degrade efficiency and radiate noise, that results in over-voltage stress on devices. Careful component placement layout and printed circuit design can minimize the voltage spikes induced in the converter. Consider, as an example, the turn-off transition of the upper MOSFET prior to turn-off, the upper MOSFET was carrying the full load current. During turn-off, current stops flowing in the upper MOSFET and is picked up by the low side MOSFET or schottky diode. Any inductance in the switched current path generates a large voltage spike during the switching interval. Careful component selections, layout of the critical components, and use shorter and wider PCB traces help in minimizing the magnitude of voltage spikes.

There are two sets of critical components in a DC-DC converter using the RT9218. The switching power components are most critical because they switch large amounts of energy, and as such, they tend to generate equally large amounts of noise. The critical small signal components are those connected to sensitive nodes or those supplying critical bypass current.

The power components and the PWM controller should be placed firstly. Place the input capacitors, especially the high-frequency ceramic decoupling capacitors, close to the power switches. Place the output inductor and output capacitors between the MOSFETs and the load. Also locate the PWM controller near by MOSFETs.

A multi-layer printed circuit board is recommended.

Figure 10 shows the connections of the critical components in the converter. Note that the capacitors  $C_{IN}$  and  $C_{OUT}$  each of them represents numerous physical capacitors. Use a dedicated grounding plane and use vias to ground all critical components to this layer. Apply another solid layer as a power plane and cut this plane into smaller islands of common voltage levels. The power plane should support the input power and output power nodes. Use copper filled polygons on the top and bottom circuit layers for the PHASE node, but it is not necessary to oversize this particular island. Since the PHASE node is subjected to very high  $dV/dt$  voltages, the stray capacitance formed between these island and the surrounding circuitry will tend to couple switching noise. Use the remaining printed circuit layers for small signal routing. The PCB traces between the PWM controller and the gate of MOSFET and also the traces connecting source of MOSFETs should be sized to carry 2A peak currents.

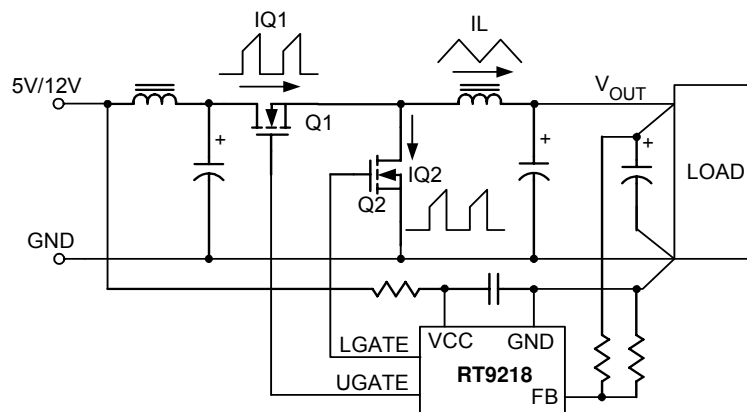
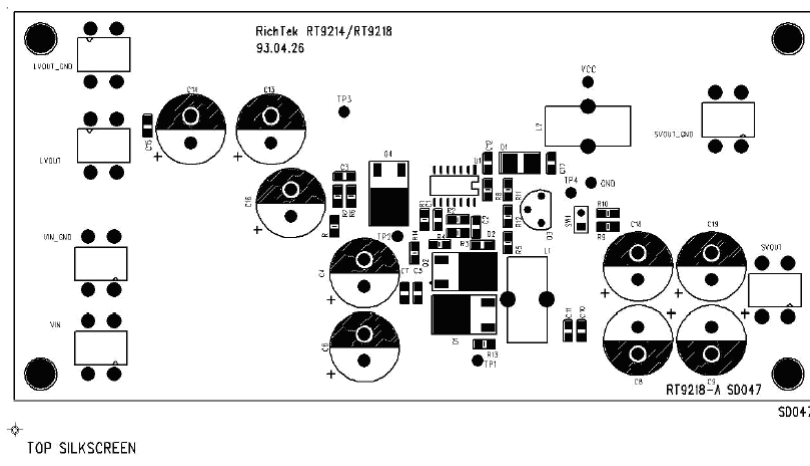
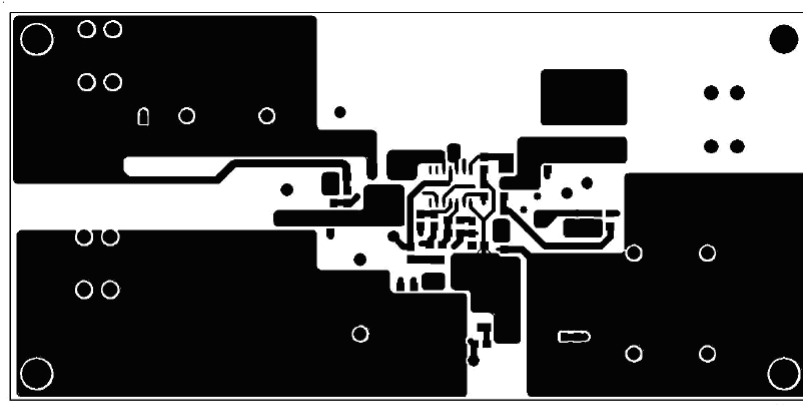

Figure 10. The connections of the critical components in the converter

Below PCB gerber files are our test board for your reference :







SD047

L1 COMPONENT SIDE

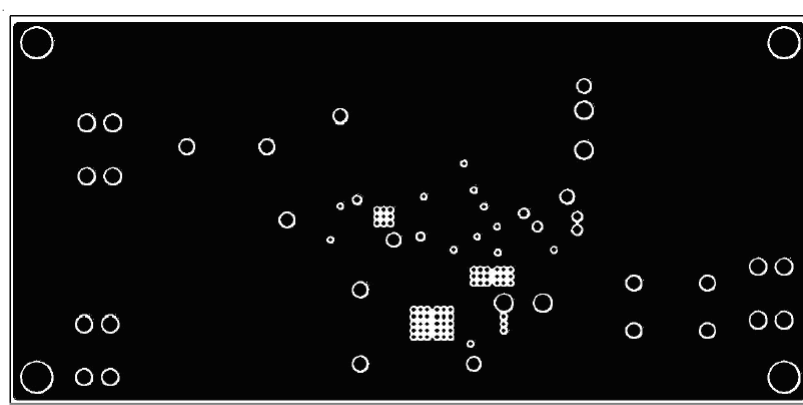

SD047

L2 GND

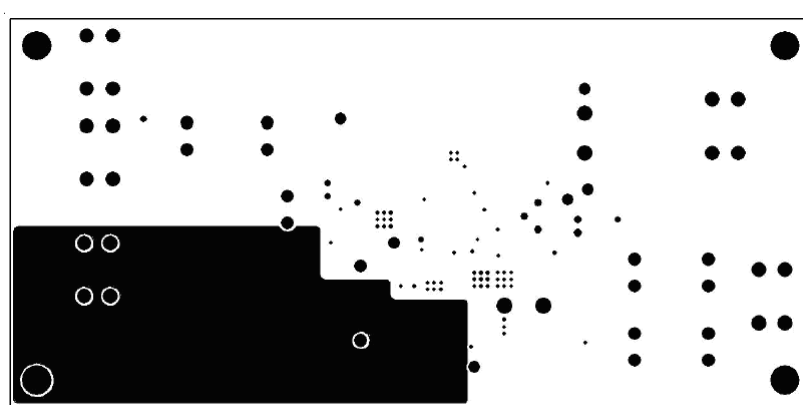

SD047

L3 POWER

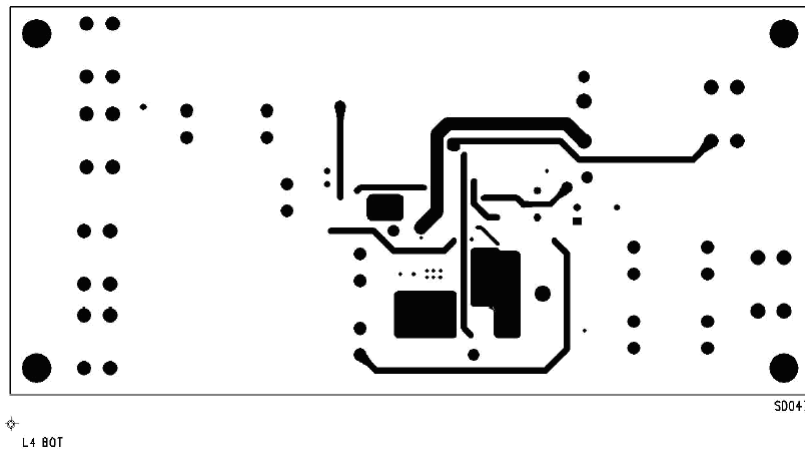

According to our test experience, you must still notice two items to avoid noise coupling :

1. The ground plane should not be separated.
2.  $V_{CC}$  rail adding the LC filter is recommended.

Outline Dimension

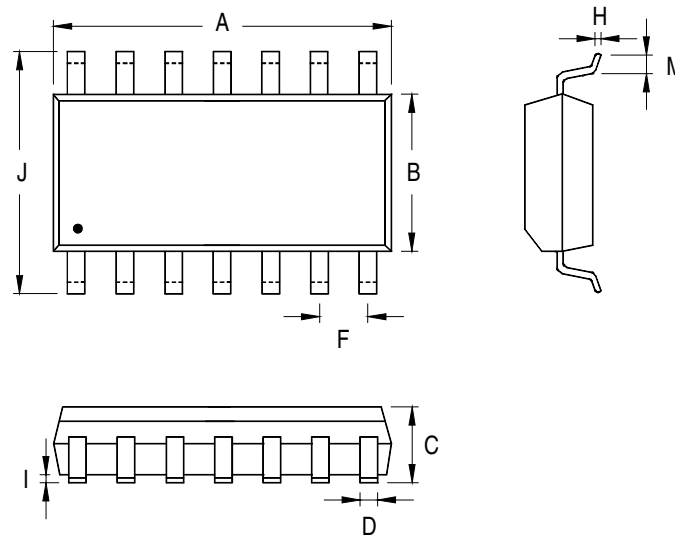

Symbol	Dimensions In Millimeters		Dimensions In Inches	
	Min	Max	Min	Max
A	8.534	8.738	0.336	0.344
B	3.810	3.988	0.150	0.157
C	1.346	1.753	0.053	0.069
D	0.330	0.508	0.013	0.020
F	1.194	1.346	0.047	0.053
H	0.178	0.254	0.007	0.010
I	0.102	0.254	0.004	0.010
J	5.791	6.198	0.228	0.244
M	0.406	1.270	0.016	0.050

14-Lead SOP Plastic Package

**Richtek Technology Corporation**

Headquarter  
 5F, No. 20, Taiyuen Street, Chupei City  
 Hsinchu, Taiwan, R.O.C.  
 Tel: (8863)5526789 Fax: (8863)5526611

**Richtek Technology Corporation**

Taipei Office (Marketing)  
 5F, No. 95, Minchiuan Road, Hsintien City  
 Taipei County, Taiwan, R.O.C.  
 Tel: (8862)86672399 Fax: (8862)86672377  
 Email: marketing@richtek.com

Information that is provided by Richtek Technology Corporation is believed to be accurate and reliable. Richtek reserves the right to make any change in circuit design, specification or other related things if necessary without notice at any time. No third party intellectual property infringement of the applications should be guaranteed by users when integrating Richtek products into any application. No legal responsibility for any said applications is assumed by Richtek.