

Chipsmall Limited consists of a professional team with an average of over 10 year of expertise in the distribution of electronic components. Based in Hongkong, we have already established firm and mutual-benefit business relationships with customers from,Europe,America and south Asia,supplying obsolete and hard-to-find components to meet their specific needs.

With the principle of “Quality Parts,Customers Priority,Honest Operation,and Considerate Service”,our business mainly focus on the distribution of electronic components. Line cards we deal with include Microchip,ALPS,ROHM,Xilinx,Pulse,ON,Everlight and Freescale. Main products comprise IC,Modules,Potentiometer,IC Socket,Relay,Connector.Our parts cover such applications as commercial,industrial, and automotives areas.

We are looking forward to setting up business relationship with you and hope to provide you with the best service and solution. Let us make a better world for our industry!



Contact us

Tel: +86-755-8981 8866 Fax: +86-755-8427 6832

Email & Skype: info@chipsmall.com Web: www.chipsmall.com

Address: A1208, Overseas Decoration Building, #122 Zhenhua RD., Futian, Shenzhen, China

DC-DC Converter (-20V, -3.0A)

RTL030P02

●Features

- 1) Low on-resistance. (80mΩ at 2.5V)
- 2) High power package.
- 3) High speed switching.
- 4) Low voltage drive. (2.5V)

●Applications

DC-DC converter

●Structure

Silicon P-channel
MOS FET

●Packaging specifications

Type	Package	Taping
	Code	TR
	Basic ordering unit (pieces)	3000
RTL030P02		○

●External dimensions (Unit : mm)

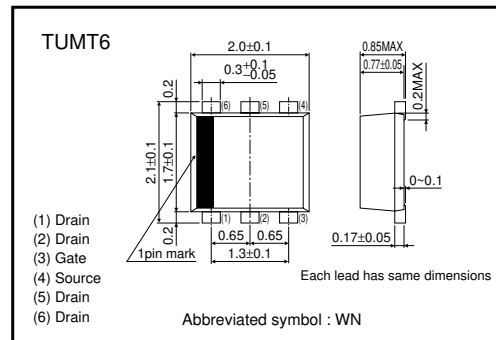

●Equivalent circuit

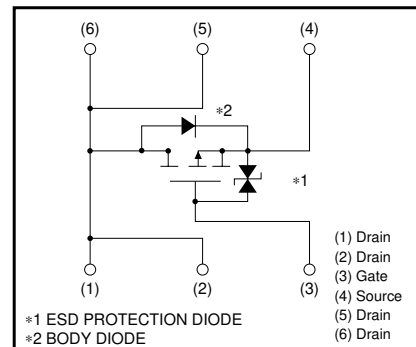

Transistors

●Absolute maximum ratings (Ta=25°C)

Parameter	Symbol	Limits	Unit
Drain-source voltage	V _{DSS}	-20	V
Gate-source voltage	V _{GSS}	±12	V
Drain current	Continuous	I _D	±3 A
	Pulsed	I _{DP}	±12 A *1
Source current (Body diode)	Continuous	I _S	-0.8 A *1
	Pulsed	I _{SP}	-12 A
Total power dissipation	P _D	1	W *2
Channel temperature	T _{ch}	150	°C
Range of Storage temperature	T _{stg}	-55 to +150	°C

*1 P_w≤10μs, Duty cycle≤1%

*2 Mounted on a ceramic board

●Electrical characteristics (Ta=25°C)

Parameter	Symbol	Min.	Typ.	Max.	Unit	Conditions
Gate-source leakage	I _{GSS}	-	-	±10	μA	V _{GS} =±12V, V _{DS} =0V
Drain-source breakdown voltage	V _{(BR) DSS}	-20	-	-	V	I _D =-1mA, V _{GS} =0V
Zero gate voltage drain current	I _{DSS}	-	-	-1	μA	V _{DS} =-20V, V _{GS} =0V
Gate threshold voltage	V _{GS(th)}	-0.7	-	-2.0	V	V _{DS} =-10V, I _D =-1mA
Static drain-source on-state resistance	R _{DS(on)}	-	50	70	mΩ	I _D =-3.0A, V _{GS} =-4.5V *
		-	55	77	mΩ	I _D =-3.0A, V _{GS} =-4V *
		-	90	125	mΩ	I _D =-1.5A, V _{GS} =-2.5V *
Forward transfer admittance	Y _{fs}	2.0	-	-	S	V _{DS} =-10V, I _D =-1.5A *
Input capacitance	C _{iss}	-	760	-	pF	V _{DS} =-10V
Output capacitance	C _{oss}	-	125	-	pF	V _{GS} =0V
Reverse transfer capacitance	C _{rss}	-	100	-	pF	f=1MHz
Turn-on delay time	t _{d(on)}	-	12	-	ns	I _D =-1.5A *
Rise time	t _r	-	25	-	ns	V _{DD} ≐-15V *
Turn-off delay time	t _{d(off)}	-	50	-	ns	V _{GS} =-4.5V *
Fall time	t _f	-	22	-	ns	R _L =10Ω *
Total gate charge	Q _g	-	8.0	-	nC	V _{DD} ≐-15V R _L ≐5Ω
Gate-source charge	Q _{gs}	-	1.5	-	nC	V _{GS} =-4.5V R _{GS} =10Ω
Gate-drain charge	Q _{gd}	-	2.5	-	nC	I _D =-3A

*Pulsed

Body diode characteristics (source-drain characteristics)

Forward voltage	V _{SD}	-	-	-1.2	V	I _S =-0.8A, V _{GS} =0V
-----------------	-----------------	---	---	------	---	--

Transistors

●Electrical characteristic curves

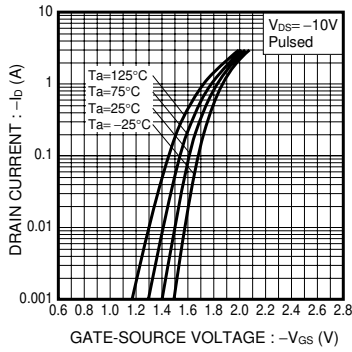

Fig.1 Typical Transfer Characteristics

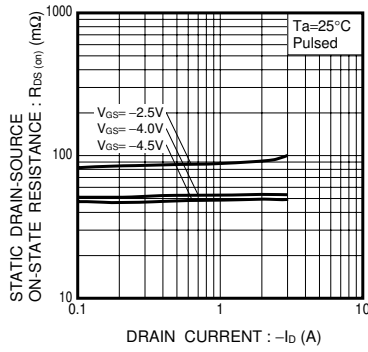

Fig.2 Static Drain-Source On-State Resistance vs. Drain Current

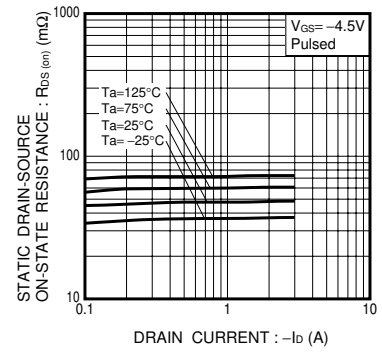

Fig.3 Static Drain-Source On-State Resistance vs. Drain Current

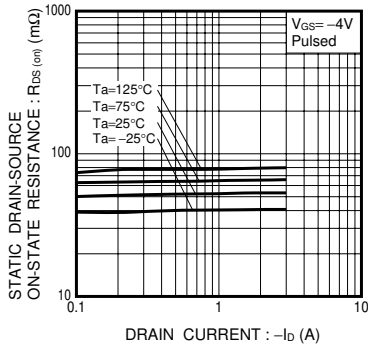

Fig.4 Static Drain-Source On-State Resistance vs. Drain Current

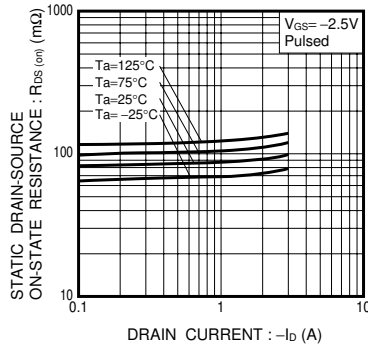

Fig.5 Static Drain-Source On-State Resistance vs. Drain Current

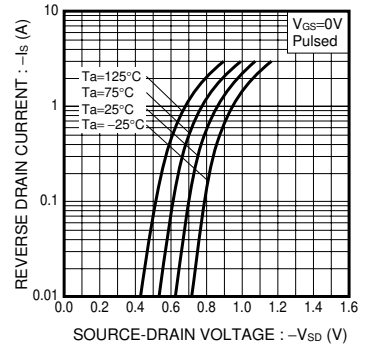

Fig.6 Reverse Drain Current vs. Source-Drain Voltage

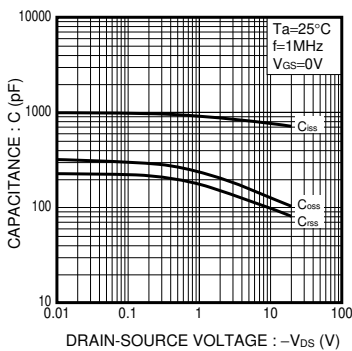

Fig.7 Typical Capacitance vs. Drain-Source Voltage

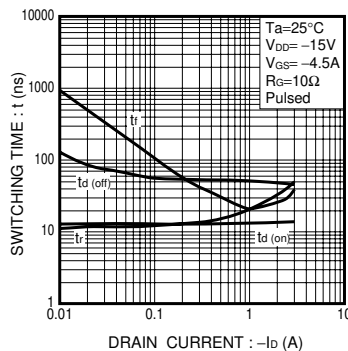

Fig.8 Switching Characteristics

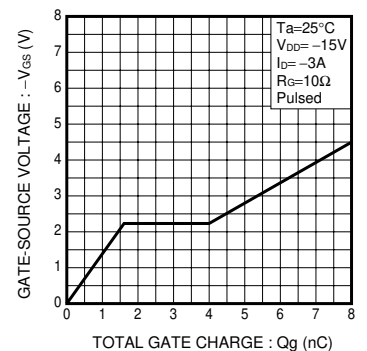

Fig.9 Dynamic Input Characteristics

Transistors

●Measurement circuits

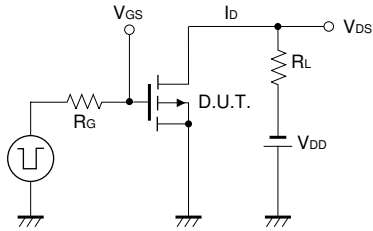

Fig.10 Switching Time Measurement Circuit

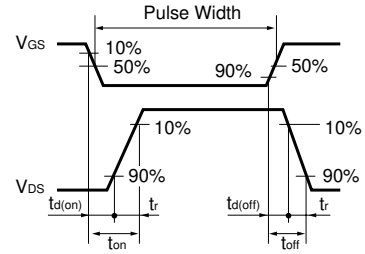

Fig.11 Switching Waveforms

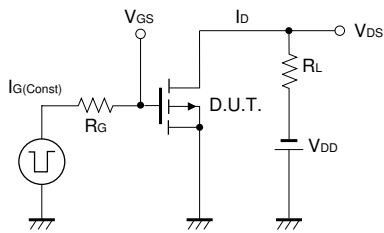

Fig.12 Gate Charge Measurement Circuit

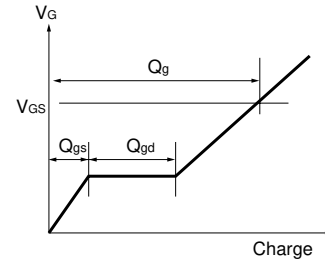

Fig.13 Gate Charge Waveforms

Notes

- No technical content pages of this document may be reproduced in any form or transmitted by any means without prior permission of ROHM CO.,LTD.
- The contents described herein are subject to change without notice. The specifications for the product described in this document are for reference only. Upon actual use, therefore, please request that specifications to be separately delivered.
- Application circuit diagrams and circuit constants contained herein are shown as examples of standard use and operation. Please pay careful attention to the peripheral conditions when designing circuits and deciding upon circuit constants in the set.
- Any data, including, but not limited to application circuit diagrams information, described herein are intended only as illustrations of such devices and not as the specifications for such devices. ROHM CO.,LTD. disclaims any warranty that any use of such devices shall be free from infringement of any third party's intellectual property rights or other proprietary rights, and further, assumes no liability of whatsoever nature in the event of any such infringement, or arising from or connected with or related to the use of such devices.
- Upon the sale of any such devices, other than for buyer's right to use such devices itself, resell or otherwise dispose of the same, no express or implied right or license to practice or commercially exploit any intellectual property rights or other proprietary rights owned or controlled by
- ROHM CO., LTD. is granted to any such buyer.
- Products listed in this document use silicon as a basic material.
Products listed in this document are no antiradiation design.

The products listed in this document are designed to be used with ordinary electronic equipment or devices (such as audio visual equipment, office-automation equipment, communications devices, electrical appliances and electronic toys).

Should you intend to use these products with equipment or devices which require an extremely high level of reliability and the malfunction of which would directly endanger human life (such as medical instruments, transportation equipment, aerospace machinery, nuclear-reactor controllers, fuel controllers and other safety devices), please be sure to consult with our sales representative in advance.

About Export Control Order in Japan

Products described herein are the objects of controlled goods in Annex 1 (Item 16) of Export Trade Control Order in Japan.

In case of export from Japan, please confirm if it applies to "objective" criteria or an "informed" (by MITI clause) on the basis of "catch all controls for Non-Proliferation of Weapons of Mass Destruction.