



Chipsmall Limited consists of a professional team with an average of over 10 year of expertise in the distribution of electronic components. Based in Hongkong, we have already established firm and mutual-benefit business relationships with customers from,Europe,America and south Asia,supplying obsolete and hard-to-find components to meet their specific needs.

With the principle of “Quality Parts,Customers Priority,Honest Operation,and Considerate Service”,our business mainly focus on the distribution of electronic components. Line cards we deal with include Microchip,ALPS,ROHM,Xilinx,Pulse,ON,Everlight and Freescale. Main products comprise IC,Modules,Potentiometer,IC Socket,Relay,Connector.Our parts cover such applications as commercial,industrial, and automotives areas.

We are looking forward to setting up business relationship with you and hope to provide you with the best service and solution. Let us make a better world for our industry!



## Contact us

Tel: +86-755-8981 8866 Fax: +86-755-8427 6832

Email & Skype: info@chipsmall.com Web: www.chipsmall.com

Address: A1208, Overseas Decoration Building, #122 Zhenhua RD., Futian, Shenzhen, China



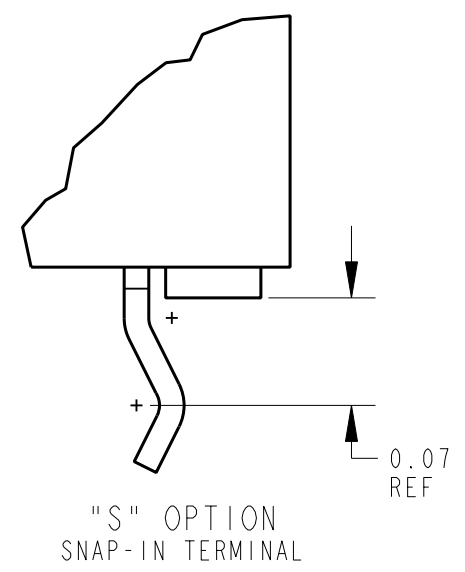
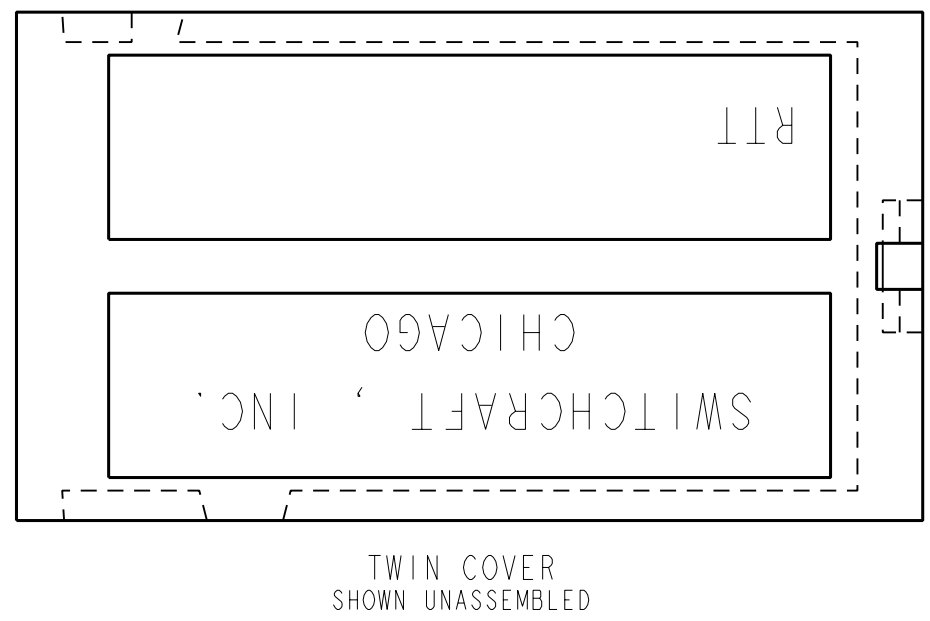
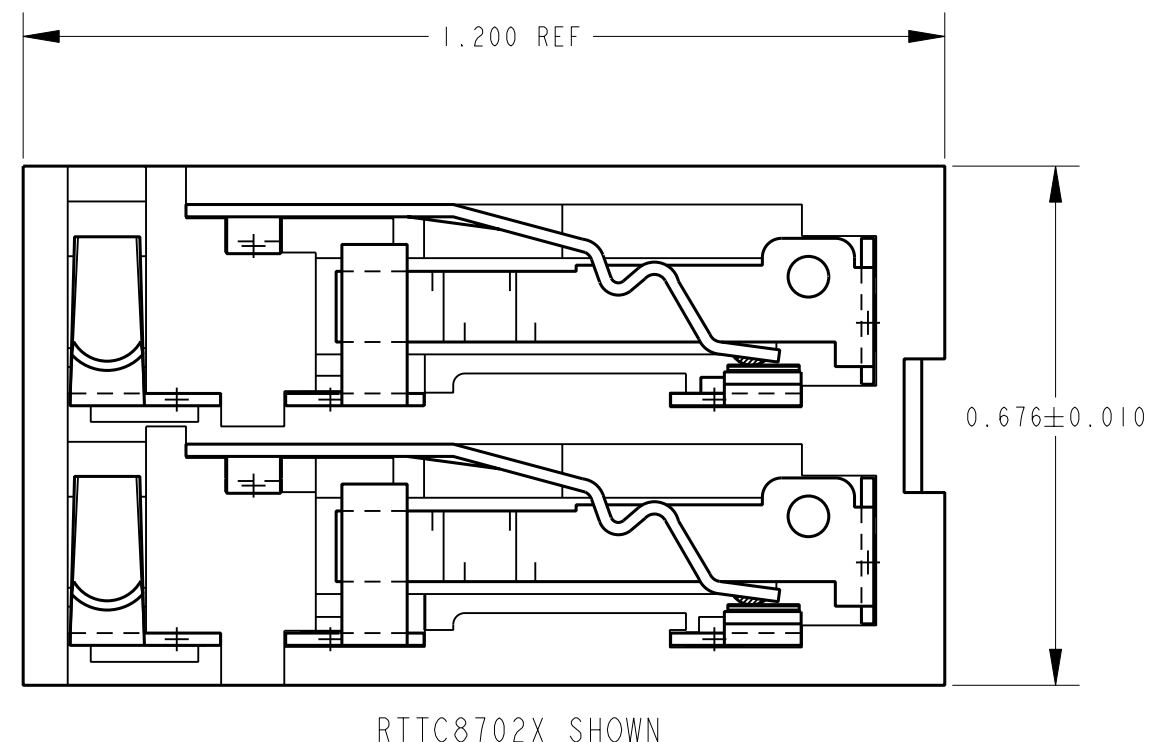
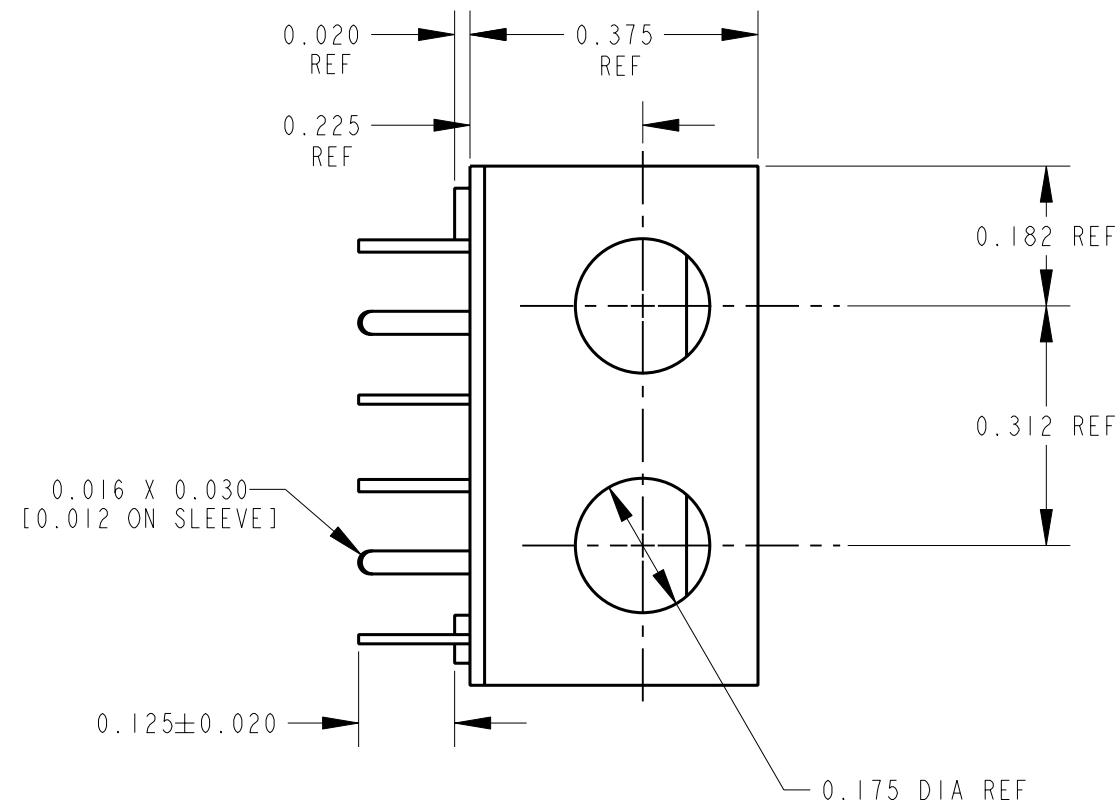

- RTT**
- 87**
- X**
- COVER
  - BLANK - NO COVER
  - "C" - COVER ASSEMBLED
- TWIN TT SERIES
- HOUSING COLOR
  - 01 - RED
  - 02 - BLACK
  - 04 - BLUE
  - 05 - WHITE
  - 07 - ORANGE
  - 08 - YELLOW
- TERMINAL STYLE
  - BLANK - PC TERMINALS
  - "S" - SNAP-IN TERMINALS
- RoHS COMPLIANT

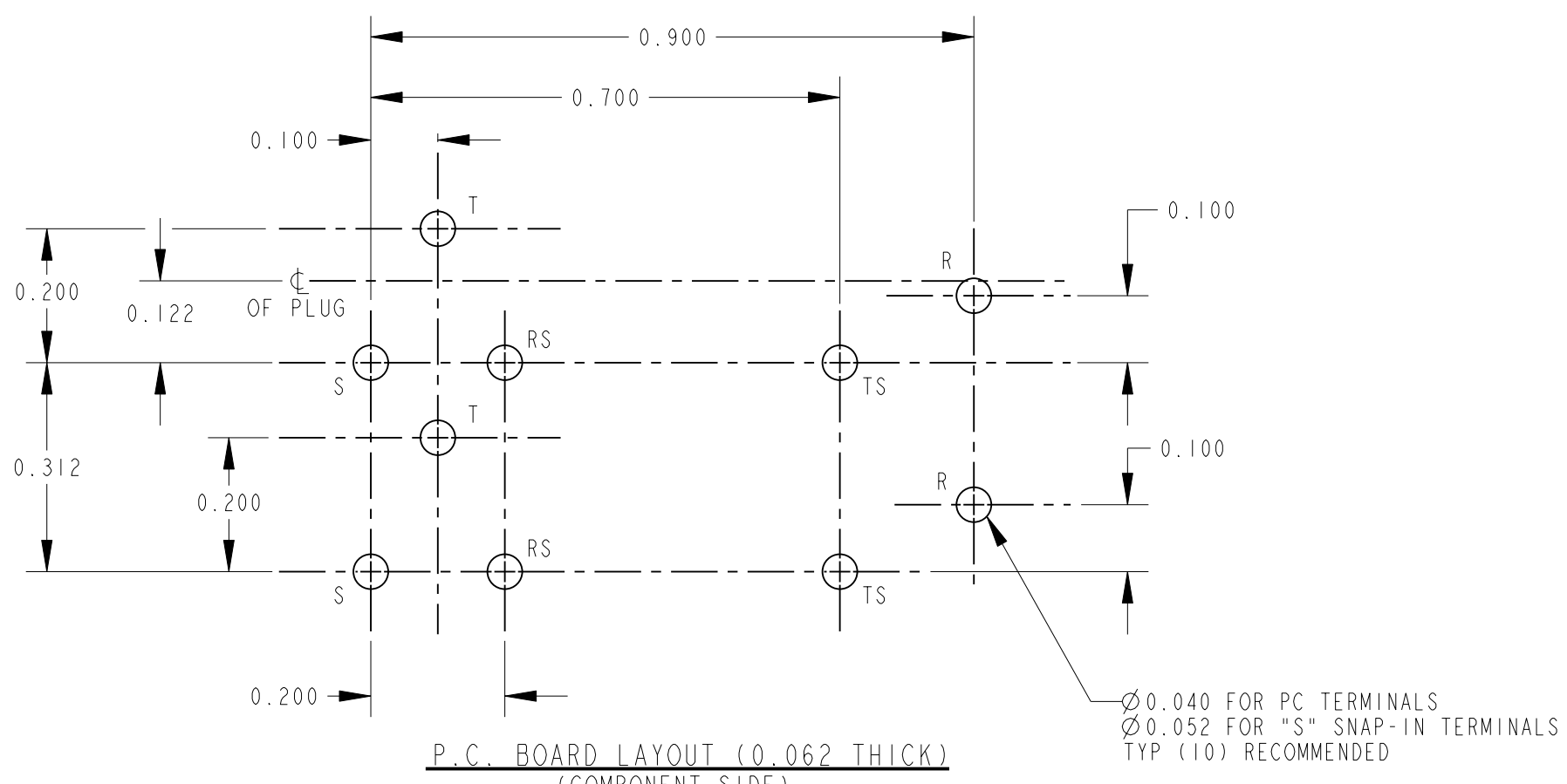
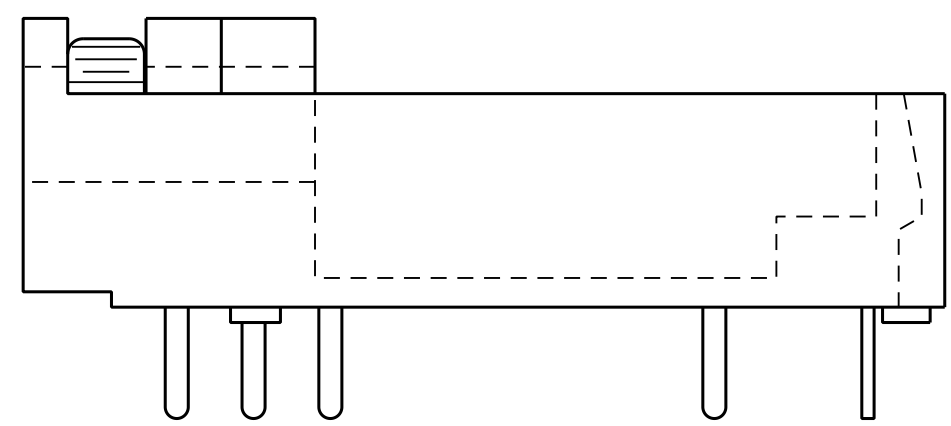

- NOTES:
1. MATES WITH SWITCHCRAFT PLUG TT-253 OR TT-263.
  2. SPECIFICATIONS:
    - ELECTRICAL:
      - DIELECTRIC WITHSTANDING VOLTAGE 500VAC.
      - CONTACT RESISTANCE 0.020 Ω MAX (INITIAL)
      - 0.030 Ω MAX (AFTER LIFE TEST.)
      - INSULATION RESISTANCE 10<sup>10</sup> Ω AT 500 VDC (INITIAL)
    - ENVIRONMENTAL:
      - THERMAL LIMITS -55°C TO 85°C (NON OPERATING)
      - THERMAL SHOCK MIL-STD-202 METHOD 107
      - SALT SPRAY MIL-STD-202 METHOD 101
      - MOISTURE RESISTANCE MIL-STD-202 METHOD 106 (LESS STEPS 7A & 7B)
    - MECHANICAL:
      - SHOCK MIL-STD-202 METHOD 213
      - VIBRATION MIL-STD-202 METHOD 201
      - INSERTION FORCE 7 LBS MAX (31.14 N)
      - WITHDRAWAL FORCE 1.5 LBS MAX (6.67 N)
    - MATERIALS:
      - HOUSING GLASS FILLED THERMOPLASTIC UL94V-0
      - SPRINGS COPPER ALLOY, SILVER PLATED
      - CONTACTS GOLD ALLOY (W.E.#1) CROSSBAR
    - MECHANICAL LIFE:
      - 10K CYCLES
  3. THIS PRODUCT IS RoHS COMPLIANT.

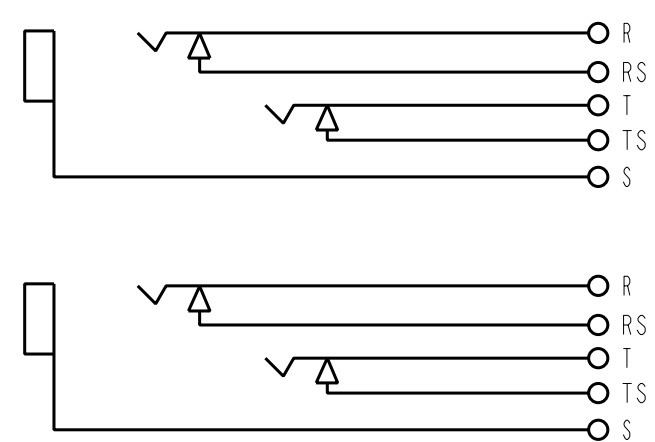
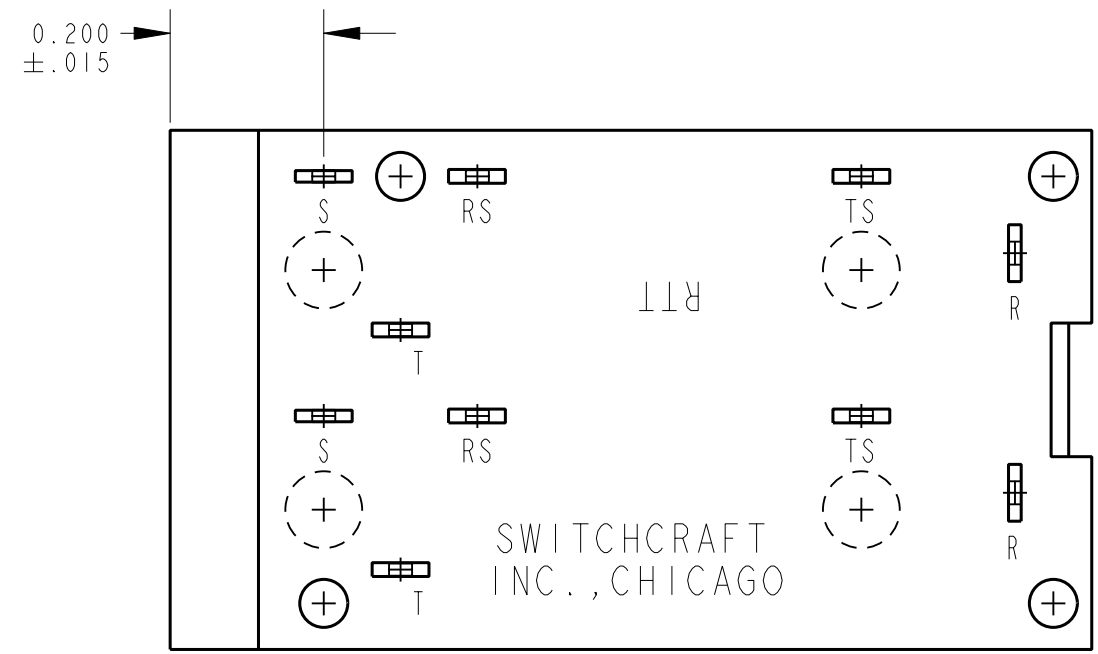

SCHEMATIC

CUSTOMER DRAWING

☆ STAR SYMBOL DENOTES CRITICAL DIMENSION UNLESS OTHERWISE SPECIFIED 1. ALL DIMENSIONS IN INCHES - TWO PLACE DECIMALS ±0.01 - THREE PLACE DECIMALS ±0.005 - ANGLES ±1° - ALL DIA. CONCENTRIC WITHIN 0.005 T.I.R. 2. FEATURES ON THE SAME CENTERLINE MUST BE ALIGNED WITHIN ±0.002 3. REMOVE ALL BURRS DO NOT SCALE DRAWING					THIS DRAWING DESCRIBES A DESIGN CONSIDERED PROPRIETARY IN NATURE, DEVELOPED AND MANUFACTURED BY SWITCHCRAFT INC. AND IS RELEASED ON A CONFIDENTIAL BASIS FOR IDENTIFICATION PURPOSES ONLY.				
SIZE		WIDTH		MULT		LBS/M		TEMPER	
FINISH SPEC No.						MATERIAL SPEC No.			
FIRST USED ON						SCALE 4:1			
DATE DRAWN	BY	CHKD	APVD						
07-Aug-08	JEB	JEB	TJK						
			08-08-08						
NAME						RIGHT ANGLE TWIN		PART No.	
TT JAX - 3 CONDUCTOR, RoHS						RTT87-RTTC87 SERIES		REV A	
REVISIONS									

