



Chipsmall Limited consists of a professional team with an average of over 10 year of expertise in the distribution of electronic components. Based in Hongkong, we have already established firm and mutual-benefit business relationships with customers from,Europe,America and south Asia,supplying obsolete and hard-to-find components to meet their specific needs.

With the principle of “Quality Parts,Customers Priority,Honest Operation,and Considerate Service”,our business mainly focus on the distribution of electronic components. Line cards we deal with include Microchip,ALPS,ROHM,Xilinx,Pulse,ON,Everlight and Freescale. Main products comprise IC,Modules,Potentiometer,IC Socket,Relay,Connector.Our parts cover such applications as commercial,industrial, and automotives areas.

We are looking forward to setting up business relationship with you and hope to provide you with the best service and solution. Let us make a better world for our industry!



## Contact us

Tel: +86-755-8981 8866 Fax: +86-755-8427 6832

Email & Skype: info@chipsmall.com Web: www.chipsmall.com

Address: A1208, Overseas Decoration Building, #122 Zhenhua RD., Futian, Shenzhen, China



# RUE Selection Guide and Product Data

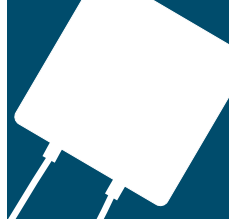

This section has two parts:

- **A Selection Guide that walks you through the process of selecting the correct RUE device for a circuit.**
- **Product Data that outlines electrical characteristics, physical characteristics, agency recognitions, environmental specifications, component layouts, tape and reel specifications, and ordering information for RUE devices.**

## RUE Selection Guide

Follow these seven steps to select a PolySwitch RUE device for a circuit:

1. Define the operating parameters for the circuit.  
These include:
  - Maximum ambient operating temperature
  - Normal operating current
  - Maximum operating voltage (RUE is 30 V maximum)
  - Maximum interrupt current
2. Select the RUE device that accommodates the circuit's maximum ambient operating temperature and normal operating current.
3. Compare the RUE device's maximum operating voltage and maximum interrupt current with the circuit's to be sure the circuit does not exceed the device ratings.
4. Check the RUE device's time-to-trip to be sure it will protect the circuit.
5. Verify that the circuit's ambient operating temperatures are within the RUE device's operating temperature range.
6. Verify that the RUE device's dimensions fit the application's space considerations.
7. Independently evaluate and test the suitability and performance of the RUE device in the application.

4



## 1. Define the circuit's operating parameters.

Fill in the following information about the circuit:

Maximum ambient operating temperature \_\_\_\_\_

Normal operating current \_\_\_\_\_

Maximum operating voltage (RUE is 30 V max.) \_\_\_\_\_

Maximum interrupt current \_\_\_\_\_

## 2. Select the PolySwitch RUE device that will accommodate the circuit's maximum ambient operating temperature and normal operating current.

Look across the top of the table below to find the temperature that most closely matches the circuit's maximum ambient operating temperature. Look down that column to find the value equal to or greater than the circuit's normal operating current. Now look to the far left of that row to find the part number for the RUE device that will best accommodate the circuit.

The thermal derating curve located on the next page is a normalized representation of the data in the table below.

### $I_{\text{Hold}}$ vs. temperature

| Part number | Maximum ambient operating temperatures (°C) |       |       |      |      |      |      |      |      |
|-------------|---|-------|-------|------|------|------|------|------|------|
|             | -40°  | -20°  | 0°    | 20°  | 40°  | 50°  | 60°  | 70°  | 85°  |
| RUE090      | 1.31  | 1.17  | 1.04  | 0.90 | 0.75 | 0.69 | 0.61 | 0.55 | 0.47 |
| RUE110      | 1.60  | 1.43  | 1.27  | 1.10 | 0.91 | 0.85 | 0.75 | 0.67 | 0.57 |
| RUE135      | 1.96  | 1.76  | 1.55  | 1.35 | 1.12 | 1.04 | 0.92 | 0.82 | 0.70 |
| RUE160      | 2.32  | 2.08  | 1.84  | 1.60 | 1.33 | 1.23 | 1.09 | 0.98 | 0.83 |
| RUE185      | 2.68  | 2.41  | 2.13  | 1.85 | 1.54 | 1.42 | 1.26 | 1.13 | 0.96 |
| RUE250      | 3.63  | 3.25  | 2.88  | 2.50 | 2.08 | 1.93 | 1.70 | 1.53 | 1.30 |
| RUE300      | 4.35  | 3.90  | 3.45  | 3.00 | 2.49 | 2.31 | 2.04 | 1.83 | 1.56 |
| RUE400      | 5.80  | 5.20  | 4.60  | 4.00 | 3.32 | 3.08 | 2.72 | 2.44 | 2.08 |
| RUE500      | 7.25  | 6.50  | 5.75  | 5.00 | 4.15 | 3.85 | 3.40 | 3.05 | 2.60 |
| RUE600      | 8.70  | 7.80  | 6.90  | 6.00 | 4.98 | 4.62 | 4.08 | 3.66 | 3.12 |
| RUE700      | 10.15                                       | 9.10  | 8.05  | 7.00 | 5.81 | 5.39 | 4.76 | 4.27 | 3.64 |
| RUE800      | 11.60                                       | 10.40 | 9.20  | 8.00 | 6.64 | 6.16 | 5.44 | 4.88 | 4.16 |
| RUE900      | 13.05                                       | 11.70 | 10.35 | 9.00 | 7.47 | 6.93 | 6.12 | 5.49 | 4.68 |

## Thermal derating curve

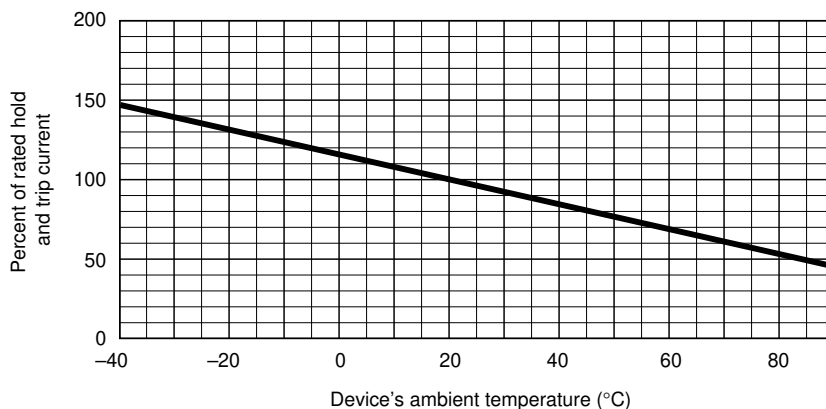

### 3. Compare maximum operating voltages and maximum interrupt currents.

Look down the first column of the table below to find the part number you selected in Step 1. Look to the right in that row to find the device's maximum operating voltage (V max.) and maximum interrupt current (I max.).



Compare both ratings with the circuit's to be sure the circuit's ratings do not exceed those of the RUE device.

#### Maximum device voltages and currents

| Part number | V max. (volts) | I max. (amps)* |
|-------------|----------------|----------------|
| RUE090      | 30             | 40             |
| RUE110      | 30             | 40             |
| RUE135      | 30             | 40             |
| RUE160      | 30             | 40             |
| RUE185      | 30             | 40             |
| RUE250      | 30             | 40             |
| RUE300      | 30             | 40             |
| RUE400      | 30             | 40             |
| RUE500      | 30             | 40             |
| RUE600      | 30             | 40             |
| RUE700      | 30             | 40             |
| RUE800      | 30             | 40             |
| RUE900      | 30             | 40             |

\*Device may withstand higher interrupt current at lower voltages. Each application will need to be individually qualified.

## 4. Determine time-to-trip.

Time-to-trip is the amount of time it takes for a device to switch to a high-resistance state once a fault current has been applied across the device.

Identifying the RUE device's time-to-trip is important in order to provide the desired protection capabilities. If the device you choose trips too fast, undesired or nuisance tripping will occur. If the device trips too slowly, the components being protected may be damaged before the device switches to a high-resistance state.

The chart below shows the typical time-to-trip at 20°C for each PolySwitch RUE device. For example, the chart indicates that the typical time-to-trip for RUE110 at 8 A is 1 second.

On the chart below, find the typical time-to-trip for the RUE device you selected. If the RUE device's time-to-trip is too fast or too slow for the circuit, go back to Step 2 and choose an alternate device.

Typical time-to-trip at 20°C

4

- A = RUE090
- B = RUE110
- C = RUE135
- D = RUE160
- E = RUE185
- F = RUE250
- G = RUE300
- H = RUE400
- I = RUE500
- J = RUE600
- K = RUE700
- L = RUE800
- M = RUE900

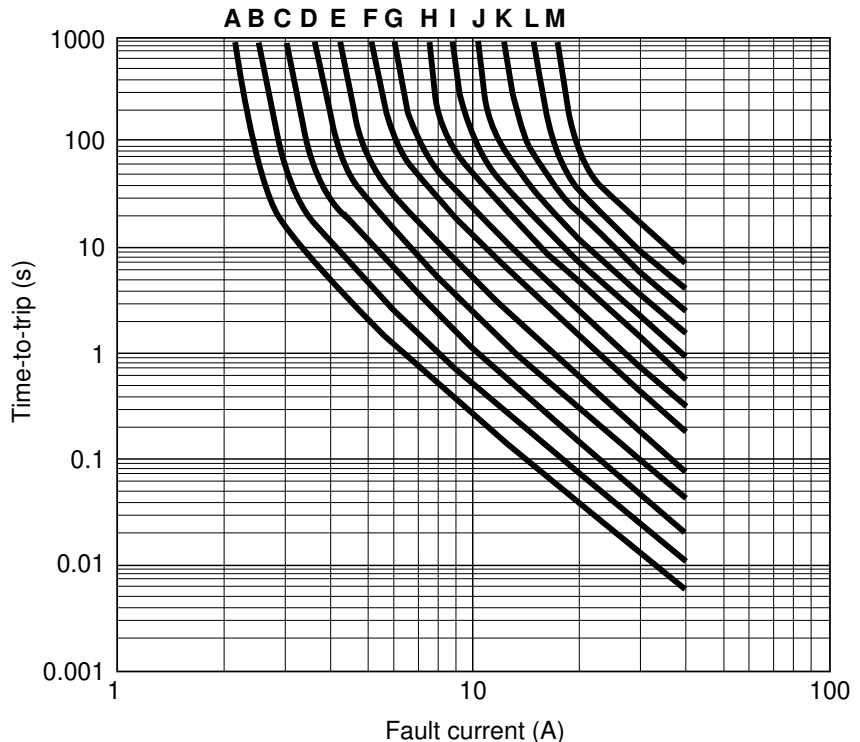

## 5. Verify ambient operating conditions.

Ensure that your application's minimum and maximum ambient temperatures are within the operating temperature range of  $-40^{\circ}\text{C}$  and  $85^{\circ}\text{C}$ .

Maximum device surface temperature in the tripped state is  $125^{\circ}\text{C}$ .

## 6. Verify the RUE device's dimensions.

Using dimensions from the table below, compare the dimensions of the RUE device you selected with the application's space considerations.

### Product dimensions (millimeters/inches)

| Part number | A<br>max.   | B<br>max.   | C<br>typ.   | D<br>min.  | E<br>max.  | F<br>typ.  |
|-------------|-------------|-------------|-------------|------------|------------|------------|
| RUE090      | 7.4 (0.29)  | 12.2 (0.48) | 5.1 (0.20)  | 7.6 (0.30) | 3.0 (0.12) | 0.8 (0.03) |
| RUE110      | 7.4 (0.29)  | 14.2 (0.56) | 5.1 (0.20)  | 7.6 (0.30) | 3.0 (0.12) | 0.8 (0.03) |
| RUE135      | 8.9 (0.35)  | 13.5 (0.53) | 5.1 (0.20)  | 7.6 (0.30) | 3.0 (0.12) | 0.8 (0.03) |
| RUE160      | 8.9 (0.35)  | 15.2 (0.60) | 5.1 (0.20)  | 7.6 (0.30) | 3.0 (0.12) | 0.8 (0.03) |
| RUE185      | 10.2 (0.40) | 15.7 (0.62) | 5.1 (0.20)  | 7.6 (0.30) | 3.0 (0.12) | 0.8 (0.03) |
| RUE250      | 11.4 (0.45) | 18.3 (0.72) | 5.1 (0.20)  | 7.6 (0.30) | 3.0 (0.12) | 0.8 (0.03) |
| RUE300      | 11.4 (0.45) | 17.3 (0.68) | 5.1 (0.20)  | 7.6 (0.30) | 3.0 (0.12) | 1.2 (0.05) |
| RUE400      | 14.0 (0.55) | 20.1 (0.79) | 5.1 (0.20)  | 7.6 (0.30) | 3.0 (0.12) | 1.2 (0.05) |
| RUE500      | 14.0 (0.55) | 24.9 (0.98) | 10.2 (0.40) | 7.6 (0.30) | 3.0 (0.12) | 1.2 (0.05) |
| RUE600      | 16.5 (0.65) | 24.9 (0.98) | 10.2 (0.40) | 7.6 (0.30) | 3.0 (0.12) | 1.2 (0.05) |
| RUE700      | 19.1 (0.75) | 26.7 (1.05) | 10.2 (0.40) | 7.6 (0.30) | 3.0 (0.12) | 1.2 (0.05) |
| RUE800      | 21.6 (0.85) | 29.2 (1.15) | 10.2 (0.40) | 7.6 (0.30) | 3.0 (0.12) | 1.2 (0.05) |
| RUE900      | 24.1 (0.95) | 29.7 (1.17) | 10.2 (0.40) | 7.6 (0.30) | 3.0 (0.12) | 1.2 (0.05) |



### Lead size

RUE090–RUE250  $\varnothing$  0.51  
(0.020)  
24 AWG

RUE300–RUE900  $\varnothing$  0.81  
(0.032)  
20 AWG

### RUE090–RUE250\*

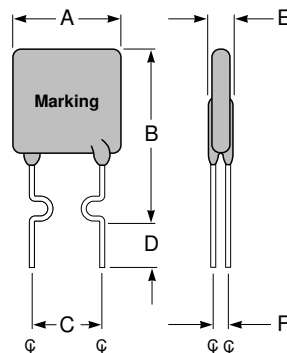

### RUE300–RUE900\*\*

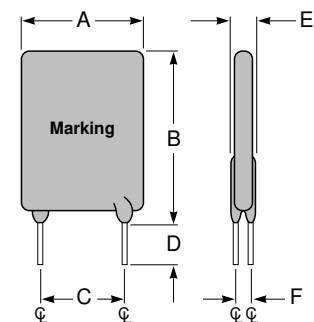

\* Straight leads are available

\*\* Kinked leads are available

# RUE Product Data

Now that you have selected your RUE device, please review the device's characteristics in this section to verify that the device will perform as required.

## Electrical characteristics (20°C)

| Part Number | I <sub>H</sub> (A) | I <sub>T</sub> (A) | Max. time to trip (s) at 5xI <sub>H</sub> | P <sub>d</sub> (W) | Initial resistance |            | Post-trip resistance    |
|-------------|--------------------|--------------------|---|--------------------|--------------------|------------|-------------------------|
|             |                    |                    |   |                    | R min. (Ω)         | R max. (Ω) | R <sub>1</sub> max. (Ω) |
| RUE090      | 0.90               | 1.80               | 5.9                                       | 0.6                | 0.070              | 0.12       | 0.22                    |
| RUE110      | 1.10               | 2.20               | 6.6                                       | 0.7                | 0.050              | 0.10       | 0.17                    |
| RUE135      | 1.35               | 2.70               | 7.3                                       | 0.8                | 0.040              | 0.08       | 0.13                    |
| RUE160      | 1.60               | 3.20               | 8.0                                       | 0.9                | 0.030              | 0.07       | 0.11                    |
| RUE185      | 1.85               | 3.70               | 8.7                                       | 1.0                | 0.030              | 0.06       | 0.09                    |
| RUE250      | 2.50               | 5.00               | 10.3                                      | 1.2                | 0.020              | 0.04       | 0.07                    |
| RUE300      | 3.00               | 6.00               | 10.8                                      | 2.0                | 0.020              | 0.05       | 0.08                    |
| RUE400      | 4.00               | 8.00               | 12.7                                      | 2.5                | 0.010              | 0.03       | 0.05                    |
| RUE500      | 5.00               | 10.00              | 14.5                                      | 3.0                | 0.010              | 0.03       | 0.05                    |
| RUE600      | 6.00               | 12.00              | 16.0                                      | 3.5                | 0.005              | 0.02       | 0.04                    |
| RUE700      | 7.00               | 14.00              | 17.5                                      | 3.8                | 0.005              | 0.02       | 0.03                    |
| RUE800      | 8.00               | 16.00              | 18.8                                      | 4.0                | 0.005              | 0.02       | 0.02                    |
| RUE900      | 9.00               | 18.00              | 20.0*                                     | 4.2                | 0.005              | 0.01       | 0.02                    |

I<sub>H</sub> = Hold current—maximum current at which the device will not trip at 20°C.

I<sub>T</sub> = Trip current—minimum current at which the device will always trip at 20°C.

P<sub>d</sub> = Typical power dissipation—typical amount of power dissipated by the device when in tripped state in 20°C still air.

R min. = Minimum device resistance at 20°C prior to tripping.

R max. = Maximum device resistance at 20°C prior to tripping.

R<sub>1</sub> max. = Maximum device resistance at 20°C measured 1 hour post trip.

\* Device tested at 40 A.

## Physical characteristics

|                           |   |
|---------------------------|---|
| Lead material             | RUE090–250: Tin lead-plated copper-clad steel, 24 AWG, Ø 0.51 mm/0.020 in<br>RUE300–900: Tin lead-plated copper, 20 AWG, Ø 0.81 mm/0.032 in |
| Soldering characteristics | Solderability per MIL-STD-202, Method 208E<br>Solder heat withstand per MIL-STD-202, Method 210, Condition B                                |
| Insulating material       | Cured, flame-retardant epoxy polymer; meets UL 94V-O requirements   |

Note: Devices are not designed to be placed through a reflow process.

## Agency recognitions

|     |                        |
|-----|------------------------|
| UL  | File # E74889          |
| CSA | File # CA78165C        |
| TÜV | Certificate # R9477318 |

## Environmental specifications

| Test               | Test method               | Conditions                 | Change resistance |
|--------------------|---------------------------|----------------------------|-------------------|
| Passive aging      | Raychem PS300             | 70°C, 1000 hours           | ±5%               |
|                    |                           | 85°C, 1000 hours           | ±5%               |
| Humidity aging     | Raychem PS300             | 85°C, 85% R.H., 1000 hours | ±5%               |
| Thermal shock      | Raychem PS300             | 125°C, -55°C (10 times)    | ±5%               |
| Solvent resistance | Raychem PS300, Method 215 | MIL-STD-202, Method 215F   | No change         |

## Component layouts

The dimensions in the table below provide the component layout for each RUE device.



## Component layout dimensions (millimeters/inches)

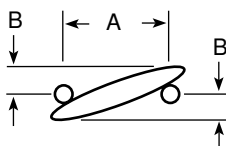

| Device | A nom.      | B max.     |
|--------|-------------|------------|
| RUE090 | 5.1 (0.20)  | 0.8 (0.03) |
| RUE110 | 5.1 (0.20)  | 0.8 (0.03) |
| RUE135 | 5.1 (0.20)  | 1.0 (0.04) |
| RUE160 | 5.1 (0.20)  | 1.0 (0.04) |
| RUE185 | 5.1 (0.20)  | 1.0 (0.04) |
| RUE250 | 5.1 (0.20)  | 1.2 (0.05) |
| RUE300 | 5.1 (0.20)  | 1.5 (0.06) |
| RUE400 | 5.1 (0.20)  | 1.7 (0.07) |
| RUE500 | 10.2 (0.40) | 1.0 (0.04) |
| RUE600 | 10.2 (0.40) | 1.0 (0.04) |
| RUE700 | 10.2 (0.40) | 1.2 (0.05) |
| RUE800 | 10.2 (0.40) | 1.5 (0.06) |
| RUE900 | 10.2 (0.40) | 1.5 (0.06) |



## Tape and reel specifications (dimensions in millimeters)

Product availability: RUE090–RUE400

Devices taped using EIA468-B/IEC286-2 standards. See table below and Figures 1 and 2 for details.

| Dimension description                            | EIA mark   | IEC mark   | Dimensions    |              |
|--|------------|------------|---------------|--------------|
|  |            |            | Dim. (mm)     | Tol. (mm)    |
| Carrier tape width                               | $W$        | $W$        | 18            | $-0.5/+1.0$  |
| Hold down tape width: RUE090-RUE250              | $W_4$      | $W_0$      | 11            | min.         |
| Top distance between tape edges                  | $W_6$      | $W_2$      | 3             | max.         |
| Sprocket hole position                           | $W_5$      | $W_1$      | 9             | $-0.5/+0.75$ |
| Sprocket hole diameter*                          | $D_0$      | $D_0$      | 4             | $-0.32/+0.2$ |
| Abscissa to plane (straight lead)                | $H$        | $H$        | 18.5          | $\pm 3.0$    |
| Abscissa to plane (kinked lead)                  | $H_0$      | $H_0$      | 16            | $\pm 0.5$    |
| Abscissa to top RUE090–185                       | $H_1$      | $H_1$      | 32.2          | max.         |
| Abscissa to top RUE250–400*                      |            |            | 35.4          | max.         |
| Overall width w/lead protrusion RUE090–RUE250    | $C_1$      |            | 43.2          | max.         |
| Overall width w/lead protrusion RUE250           |            |            | 43.9          | max.         |
| Overall width w/o lead protrusion RUE090–RUE185  | $C_2$      |            | 42.5          | max.         |
| Overall width w/o lead protrusion RUE300–RUE400* |            |            | 44.2          | max.         |
| Lead protrusion                                  | $L_1$      | $l_1$      | 1.0           | max.         |
| Protrusion of cut out                            | $L$        | $L$        | 11            | max.         |
| Protrusion beyond hold-down tape                 | $l_2$      | $l_2$      | Not specified |              |
| Sprocket hole pitch: RUE090–RUE250               | $P_0$      | $P_0$      | 12.7          | $\pm 0.3$    |
| Sprocket hole pitch on RUE300–RUE400             | $P_0$      | $P_0$      | 25.4          | $\pm 0.5$    |
| Device pitch: RUE090–RUE250                      |            |            | 12.7          |              |
| Device pitch: RUE300–RUE400                      |            |            | 25.4          |              |
| Pitch tolerance                                  |            |            | 20 consec.    | $\pm 1$      |
| Tape thickness                                   | $t$        | $t$        | 0.9           | max.         |
| Tape thickness with splice RUE090-RUE250         | $t_1$      |            | 1.5           | max.         |
| Tape thickness with splice RUE300-RUE400*        | $t_1$      |            | 2.0           | max.         |
| Splice sprocket hole alignment                   |            |            | 0             | $\pm 0.3$    |
| Body lateral deviation                           | $\Delta h$ | $\Delta h$ | 0             | $\pm 1.0$    |
| Body tape plane deviation                        | $\Delta p$ | $\Delta p$ | 0             | $\pm 1.3$    |
| Ordinate to adjacent component lead*             | $P_1$      | $P_1$      | 3.81          | $\pm 1.0$    |
| Lead spacing: RUE090–RUE400*                     | $F$        | $F$        | 5.08          | $\pm 0.8$    |
| Reel width RUE090–RUE300                         | $w_2$      | $w$        | 56            | max.         |
| Reel width RUE400*                               | $w_2$      | $w$        | 63.5          | max.         |
| Reel diameter                                    | $a$        | $d$        | 370           | max.         |
| Space between flanges less device*               | $w_1$      |            | 4.75          | $3.25/+8.25$ |
| Arbor hole diameter                              | $c$        | $f$        | 26            | $\pm 12.0$   |
| Core diameter*                                   | $n$        | $h$        | 91            | max.         |
| Box  |            |            | 56/372/372    | max.         |
| Consecutive missing places                       |            |            | None          |              |
| Empty places per reel                            |            |            | 0.1% max.     |              |

\*Differs from EIA specification

**Figure 1: EIA Referenced Taped Component Dimensions**

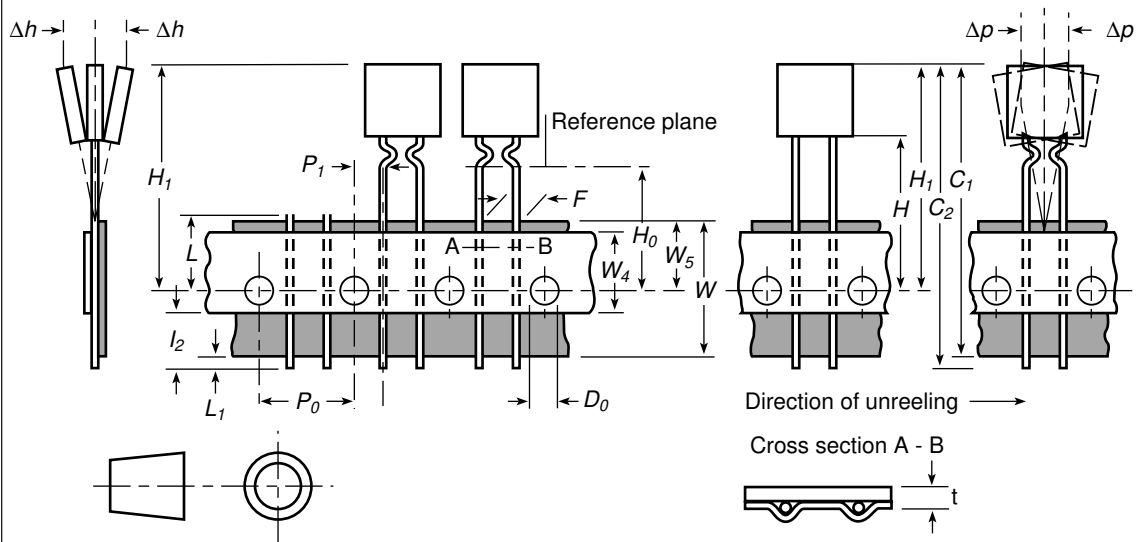

4

**Figure 2: Reel Dimensions**

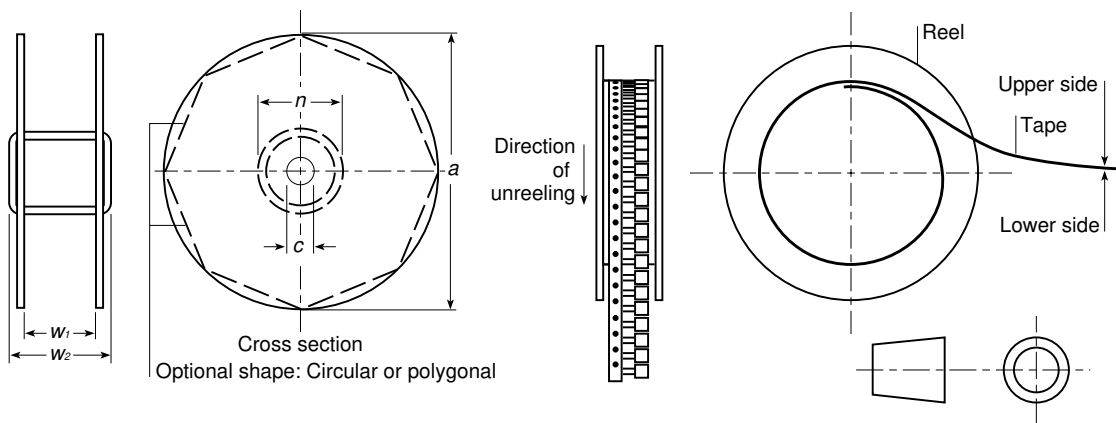

### Ordering information

| Product description | Bag quantity | Tape and reel quantity | AMMO pack | Standard package |
|---------------------|--------------|------------------------|-----------|------------------|
| RUE090              | 500          |                        |           | 10000            |
| RUE090-2            |              | 3000                   |           | 15000            |
| RUE090-AP           |              |                        | 2000      | 10000            |
| RUE110              | 500          |                        |           | 10000            |
| RUE110-2            |              | 3000                   |           | 15000            |
| RUE110-AP           |              |                        | 2000      | 10000            |
| RUE135              | 500          |                        |           | 10000            |
| RUE135-2            |              | 3000                   |           | 15000            |
| RUE135-AP           |              |                        | 2000      | 10000            |
| RUE160              | 500          |                        |           | 10000            |
| RUE160-2            |              | 3000                   |           | 15000            |
| RUE160-AP           |              |                        | 2000      | 10000            |
| RUE185              | 500          |                        |           | 10000            |
| RUE185-2            |              | 3000                   |           | 15000            |
| RUE185-AP           |              |                        | 2000      | 10000            |
| RUE250              | 500          |                        |           | 10000            |
| RUE250-2            |              | 3000                   |           | 15000            |
| RUE250-AP           |              |                        | 2000      | 10000            |
| RUE300              | 500          |                        |           | 10000            |
| RUE300-2            |              | 1500                   |           | 7500             |
| RUE300-AP           |              |                        | 1000      | 5000             |
| RUE400              | 500          |                        |           | 10000            |
| RUE400-2            |              | 1500                   |           | 7500             |
| RUE400-AP           |              |                        | 1000      | 5000             |
| RUE500              | 500          | *                      | *         | 10000            |
| RUE600              | 500          | *                      | *         | 10000            |
| RUE700              | 500          | *                      | *         | 10000            |
| RUE800              | 500          | *                      | *         | 10000            |
| RUE900              | 500          | *                      | *         | 10000            |

\*Consult Factory

### Part numbering system

RUE    suffix

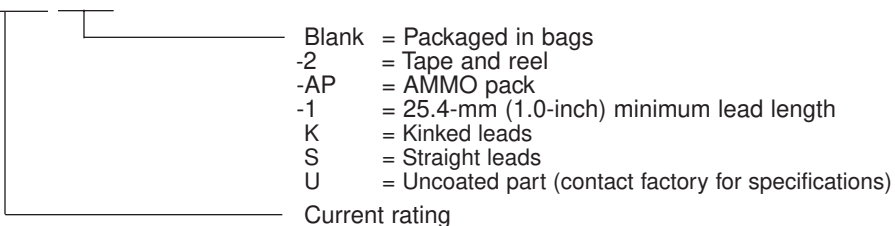

## Part marking system

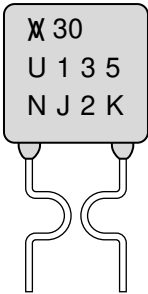

Example

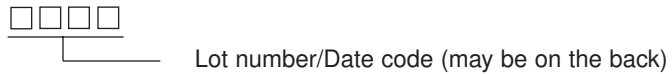
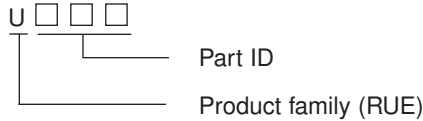
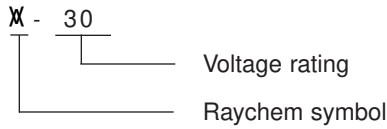

| Part description | Part ID |
|------------------|---------|
| RUE090           | 090     |
| RUE110           | 110     |
| RUE135           | 135     |
| RUE160           | 160     |
| RUE185           | 185     |
| RUE250           | 250     |
| RUE300           | 300     |
| RUE400           | 400     |
| RUE500           | 500     |
| RUE600           | 600     |
| RUE700           | 700     |
| RUE800           | 800     |
| RUE900           | 900     |

### WARNING:

- Operation beyond maximum ratings or improper use may result in device damage and possible electrical arcing and flame.
- These devices are intended for protection against occasional over-current or overtemperature fault conditions, and should not be used when repeated fault conditions are anticipated.
- Operation in circuits with inductive spikes can generate voltages above the rated voltage of the devices and should be evaluated for suitability of use.