



Chipsmall Limited consists of a professional team with an average of over 10 year of expertise in the distribution of electronic components. Based in Hongkong, we have already established firm and mutual-benefit business relationships with customers from,Europe,America and south Asia,supplying obsolete and hard-to-find components to meet their specific needs.

With the principle of “Quality Parts,Customers Priority,Honest Operation,and Considerate Service”,our business mainly focus on the distribution of electronic components. Line cards we deal with include Microchip,ALPS,ROHM,Xilinx,Pulse,ON,Everlight and Freescale. Main products comprise IC,Modules,Potentiometer,IC Socket,Relay,Connector.Our parts cover such applications as commercial,industrial, and automotives areas.

We are looking forward to setting up business relationship with you and hope to provide you with the best service and solution. Let us make a better world for our industry!



Contact us

Tel: +86-755-8981 8866 Fax: +86-755-8427 6832

Email & Skype: info@chipsmall.com Web: www.chipsmall.com

Address: A1208, Overseas Decoration Building, #122 Zhenhua RD., Futian, Shenzhen, China





FEATURES

- UL 60950 recognised for reinforced insulation
- High transient voltage withstand capability
- Ultra wide input voltage range of 16-160VDC
- Externally settable hold up time with additional capacitor
- DC OK/Power Fail signal
- Short circuit protection
- Over Temperature protection
- Over voltage protection

DESCRIPTION

The RUW series is particularly suitable for use in applications in railway, industry or telecommunication where variable input voltages or high transient voltages are present. With an ultra wide input voltage range of 16-160VDC, the RUW series is capable of withstanding surges from 24,36,48,72, 90 and 110V systems, largely eliminating the requirement for input protection circuitry.

Optional features include a Power Fail/DC OK signal and circuitry to facilitate long hold-up times with a small external capacitor across \pm Vint pins.

SELECTION GUIDE

Order Code ¹	Input Voltage Nom.	Output Voltage V	Output Current		Output Power Max. W	MTTF ³ kHrs
			Min. A	Max. A		
RUW15SL05C	SL	5	0.3	3	15	1609
RUW15SL05HC	SL	5	0.3	3	15	1218
RUW15SL12C	SL	12	0.125	1.25	15	1550
RUW15SL12HC	SL	12	0.125	1.25	15	959
RUW15SL24C	SL	24	0.0625	0.625	15	1094
RUW15SL24HC	SL	24	0.0625	0.625	15	1176

INPUT CHARACTERISTICS

Parameter	Conditions	Min.	Typ.	Max.	Units
Voltage range ²	Continuous operation SL I/P types	16		160	V
Input standby current			5.5		mA

INPUT CURRENT (10% Load)

Order Code	Input Voltage									Units
	16	24	48	60	72	96	110	132	160	V
RUW15SL05C	0.130	0.085	0.040		0.030		0.020		0.013	A
RUW15SL05HC	0.138	0.087	0.042		0.028		0.019		0.014	
RUW15SL12C	0.135	0.088	0.044	0.035	0.030	0.023	0.022	0.018	0.015	
RUW15SL12HC	0.146	0.093	0.048	0.038	0.032	0.025	0.024	0.021	0.018	
RUW15SL24C	0.160	0.102	0.053	0.043	0.036	0.029	0.028	0.025	0.021	
RUW15SL24HC	0.146	0.098	0.049	0.039	0.033	0.027	0.025	0.022	0.018	

INPUT REFLECTED RIPPLE

Order Code	Input Voltage						Units
	16	24	48	72	110	160	V
RUW15SL05C	422	327	236	203	174	154	mAp-p
RUW15SL05HC	482	273	175	135	144	106	
RUW15SL12C	332.8	309.2	184.8	155.2	138.8	119.6	
RUW15SL12HC	292.4	236.8	142.4	107	86.5	76.3	
RUW15SL24C	406.4	387.6	249.6	195.6	167.5	138.8	
RUW15SL24HC	446.4	291.2	176.4	157.2	101.8	82.7	

EFFICIENCY

Order Code	Input Voltage								Units		
	24		48		72		110		160		V
	Min.	Typ.	Min.	Typ.	Min.	Typ.	Min.	Typ.	Min.	Typ.	
RUW15SL05C	74.4	75.9	74.3	75.8	73	74.9	71.3	73.7	64.2	69	%
RUW15SL05HC	71.1	72.2	72.8	73.8	72.1	73.3	70.6	72.3	61.5	66.7	
RUW15SL12C	75.1	77.3	75.7	77.8	73.4	76.6	71.8	75.4	64.7	70	
RUW15SL12HC	70.6	73.5	73.1	75.7	71.8	75	70.4	73.9	62.1	68.1	
RUW15SL24C	74.5	78.4	74.8	78.8	73.9	77.9	72.1	75.9	64.4	70	
RUW15SL24HC	71	74.9	72.9	76.9	72.2	76.2	69.9	74.2	62.9	67.8	



1. Part numbers ending HC include optional Power Fail /DC OK signal and circuitry to facilitate long hold up time.
 2. Will operate down to 14V for 100ms as required by EN 50155 (24V system).
 3. Using Telecordia Issue 1 method I case 1 operating temperature 25C
- All specifications typical at T_a=25°C and rated output current unless otherwise s

OUTPUT CHARACTERISTICS					
Parameter	Conditions	Min.	Typ.	Max.	Units
Voltage set point accuracy	5V output		0.55	2	±%V _{OUT}
	12V & 24V output		0.8	1.5	
Overall voltage envelope			3.0		±%V _{OUT}
Line regulation	RUW15SL12C			0.5	±%
	RUW15SL12HC, RUW15SL24HC & RUW15SL05HC			0.2	
	RUW15SL24C, RUW15SL05C			1	
Load regulation	10-100% Load	12V & 24V output		0.25	±%
		5V output		1	
Ripple & noise	BW = 20MHz (24V _{IN} to 110V _{IN})	5V output	80		mVp-p
		12V output	70		
		24V output	90		
Transient response	Peak deviation (20-100% & 100-20% swing)		3.0		%V _{OUT}
	Settling time		1.5		ms
Start delay	From remote on/off RUWSLXXC		100		ms
	From application of V _{IN} RUWSLXXC		100		
Overvoltage protection	5V output			120%	V _{OUT}
	12V & 24V output			110%	
Short circuit protection	Continuous				

GENERAL CHARACTERISTICS						
Parameter	Conditions	Min.	Typ.	Max.	Units	
Switching frequency			100		kHz	
Remote on/off pin functionality	Module on		OPEN			
	Module off	12V & 24V output	0		0.5	V
		5V output	0		0.8	

ABSOLUTE MAXIMUM RATINGS	
Input voltage, SL input types	170V
Remote On/Off	20V ±5V

ISOLATION CHARACTERISTICS					
Parameter	Conditions	Min.	Typ.	Max.	Units
Isolation test voltage	Flash tested for 1 second	5000			VDC
Resistance	VISO = 500VDC		2		GΩ
Capacitance	5V _{OUT} types		64		pF
	12V _{OUT} types		60		
	24V _{OUT} types		76		

ENVIRONMENTAL CHARACTERISTICS					
Parameter	Conditions	Min.	Typ.	Max.	Units
Ambient temperature	See derating graph	-40		85	°C
Storage		-50		125	
Thermal protection	Operates at case temperature		120		
Case temperature rise above ambient	5 V 100% load, still air, see derating graph		45		
	12V, 24V 100% load, still air, see derating graph		40		

SAFETY

UL 60950

The RUW15 series has been recognised by Underwriters Laboratory (UL) to UL 60950 for reinforced insulation to a working voltage of 250Vrms in maximum temperature as shown in the derating graphs.

The RUW15 series of converters are not internally fused so to meet the requirements of UL a 3A anti-surge input line fuse should always be used. File number E151252 applies.

RoHS COMPLIANCE INFORMATION



This series is compatible with RoHS soldering systems with a peak wave solder temperature of 260°C for 10 seconds. The pin termination finish on this product series is a Gold flash (0.05-0.10 micron) over Nickel Preplate. The series is backward compatible with Sn/Pb soldering systems. Tinned tabs are provided along the case edges to provide mechanical support through slots in the PCB. Hand soldering of these tabs may be necessary to ensure satisfactory joint quality.

For further information, please visit www.murata-ps.com/rohs

APPLICATION NOTES

The RUW15 can be used as a general purpose wide input DC/DC converter simply with the addition of the recommended input capacitor, low ESR type 10uF.

Output Capacitors

The RUW series does not require output capacitors to meet datasheet specification. To meet datasheet specifications, total output capacitance should not exceed:

Output Voltage (V)	Max. Recommended Output Capacitance (µF)
5	1000
12	470
24	220

Remote ON/OFF control

The remote ON/OFF input to the RUW15 converter is referenced to the primary ground and when pulled below 0.5V, the RUW15 will not operate. The RUW15 will be operational if the pin is left open. In noisy environments, it is recommended to decouple the remote ON/OFF pin to ground with a 10nF capacitor.

Hold-up

If hold-up of the output is required on input drop-outs such as occur on battery changeovers, the RUW15 has an optional hold-up feature (-H versions) which maintains the output if the input voltage falls to zero. The hold-up time can be set by the connection of an external capacitor across the -Vint and +Vint pins. The hold-up time is independent of the input voltage applied before drop-out

Configuration for extended hold-up time

This capacitor is charged by the RUW15 to around 80 V and is internally switched into the RUW15 input upon input voltage failure. An internal diode prevents this high voltage appearing on the RUW15 input pins. The capacitor is referenced to the input ground of the RUW15 and therefore should have appropriate isolation clearance to the RUW15 output circuitry.

As drop-outs are not expected to occur in quick succession, the capacitor is allowed to recharge slowly over about one minute before full hold-up is again available. This helps to minimise internal stresses in the RUW15 converter. As an example, EN50155 requirement to maintain output for 30 ms on supply change-over (Class C2) is met with a capacitor of 220 uF rated at 100 V for any nominal input voltage up to 110 VDC with the RUW15 operating at maximum load.

The benefit conferred by the hold-up option is most evident when hold-up from low nominal voltages is required even if the wide input range of the RUW15 is not needed. In the above example to achieve 30 ms holdup with a capacitor across the input in a 24V nominal system, an expensive and large capacitor of 3900uF would be required rated at higher than the maximum input voltage.

The below graph shows values of capacitance against hold-up time for 15W loading. At lighter loads the hold-up time increases proportionally. In some applications the external capacitor could be made up from parallel multilayer ceramic parts which would dramatically improve lifetime compared with alternative electrolytic types.

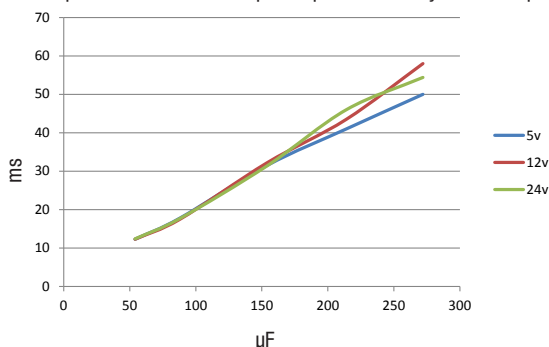

APPLICATION NOTES (continued)

Power Fail Warning Details

A 'power fail' signal is available which goes active after the input voltage drops out but before the output loses regulation. Over-temperature and over-voltage monitoring is included which also activates the 'power fail' signal. The signal goes active if the output voltage exceeds approximately 15 % of nominal, if the output is grossly less than nominal such as under short circuit conditions or if the case temperature exceeds approximately 120 degrees C. The signal is an open pnp emitter output which goes to a low voltage, typically less than 1V when active, signifying a fault. The signal goes active some milliseconds before the output drops after the converter input drops to zero, effectively giving a power fail warning.

The actual value of warning time is defined by the hold-up capacitance added as shown below. The signal can sink 50 mA and withstand 30 V in the inactive condition. The signal is referenced to RUW15 -Vout and typically is pulled to a system rail with a 10K resistor. The open emitter arrangement allows the RUW15 to actively sink current into the Power Fail output even if the RUW15 is unpowered or short circuited, correctly indicating a fault condition.

Power Fail Warning Graphs

RUW15SL12HC

Power Fail minimum ms.

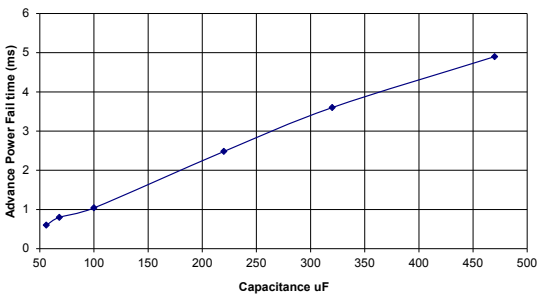

RUW15SL24HC

Power Fail minimum

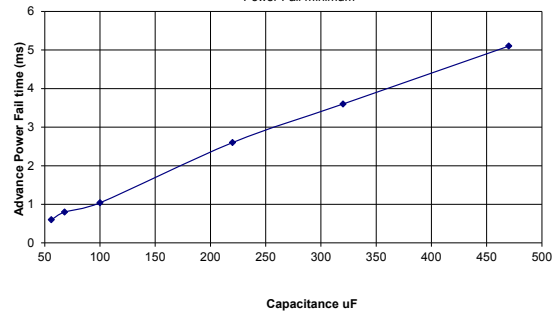

RUW15SL05HC

Power Fail minimum ms.

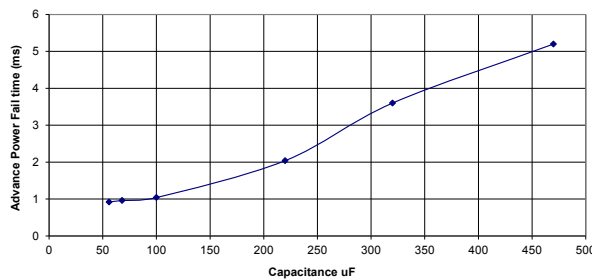

SURGE SUPPRESSION

EN50155/RIA12 surge/dip compliance

DC/DC power converters connected to the battery voltage or other low voltage source in railway rolling stock commonly have to comply with the requirements of European standard EN 50155:2007. This standard defines a range of nominal battery voltages that may be encountered with possible fluctuations and interruptions.

Nominal voltages (Un) are 24V, 48V, 72V, 96V and 110VDC with tolerances of -30/+25%. Fluctuations can take the nominal voltages up +40% for one second and down -40% for 100ms. The possible total range of nominals and fluctuations is therefore 14.4V to 154V (24V -40% to 110V +40%). Other national variations include US rail nominal battery voltages of 37V and 74V; higher surges of 1.5 x Un for one second and 3.5 x Un for 20ms found in the UK standard RIA12 and lower dips to 12V for 100ms found in the French standard NF F 01-510.

Figure 1 summarises this. The ranges of voltages for the French standard NF F 01-510 and for the USA are also shown for information. Additionally, according to EN 50155, complete interruptions of the supply can last for up to 10ms (Class S2) or 30ms during supply changeover (Class C2).

Figure 1 - Summary of nominal voltages and variations for rail applications

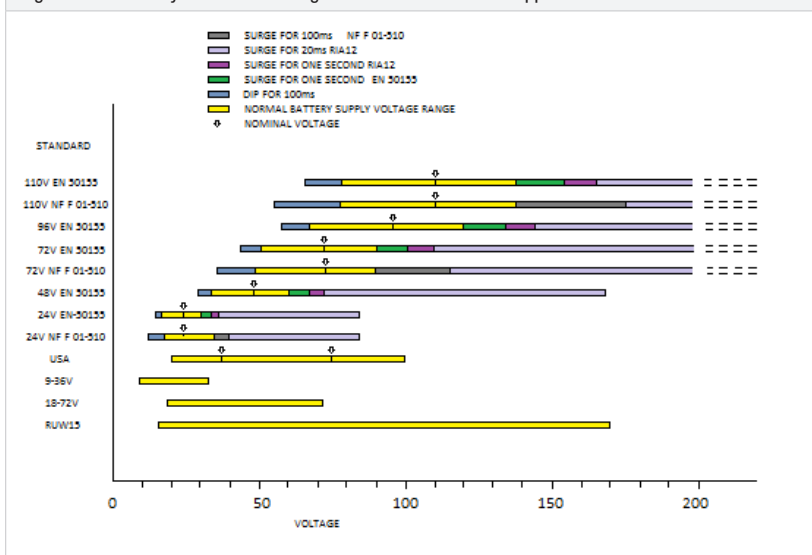

Tables 1, 2 and 3 show how the RUW15 can be configured to cover all of these requirements:

Table 1 - RIA12 SURGES AND TRANSIENTS

Nominal Input	Input range	Brown-out 100ms (0.6xVin)	Transient 1s (1.5xVin)	Transient 20ms (3.5 x Vin)	Solution
24 V	16.6 - 30V	14.4V	36V	84V	RUW15H
37.5 V	26 - 47V	22.5V	56.25V	131.25V	RUW15
48 V	33.6 - 60V	28.8V	72V	168V	RUW15
72 V	50.4V - 90V	43.2V	112.5V	252V	RUW15 + limiter
96 V	67.2 - 120V	57.6V	144V	336V	RUW15 + limiter
110 V	77 - 137.5V	66V	165V	385V	RUW15 + limiter

Table 2 - EN50155 SURGES AND TRANSIENTS

Nominal Input	Input range	Brown-out 100ms (0.6xVin)	Transient 1s (1.4xVin)	Solution
24 V	16.6 - 30 V	14.4 V	33.6 V	RUW15H
37.5 V	26 - 47 V	22.5 V	52.5 V	RUW15
48 V	33.6 - 60 V	28.8 V	67.2 V	RUW15
72 V	50.4V - 90 V	43.2 V	100.8 V	RUW15
96 V	67.2 - 120 V	57.6 V	134.4 V	RUW15
110 V	77 - 137.5 V	66 V	154 V	RUW15

SURGE SUPPRESSION (continued)

Table 3 - NF F 01-510 SURGES AND TRANSIENTS

Nominal Input	Input range	Brown-out 100ms (0.5xVin)	Transient 100ms	Solution
24 V	18 - 34 V	12V	40V	RUW15H
72 V	50 - 90 V	36V	115V	RUW15
110 V	77 - 137 V	55V	176V	RUW15 + limiter

EN 50155 also defines low energy surges and transient burst immunity requirements according to EN 50121-3-2. These are handled by a transorb, D4 in Figure 2. D6 is for reverse polarity protection and may be omitted if this function is not required.

Figure 2 – Suggested surge limiting circuit

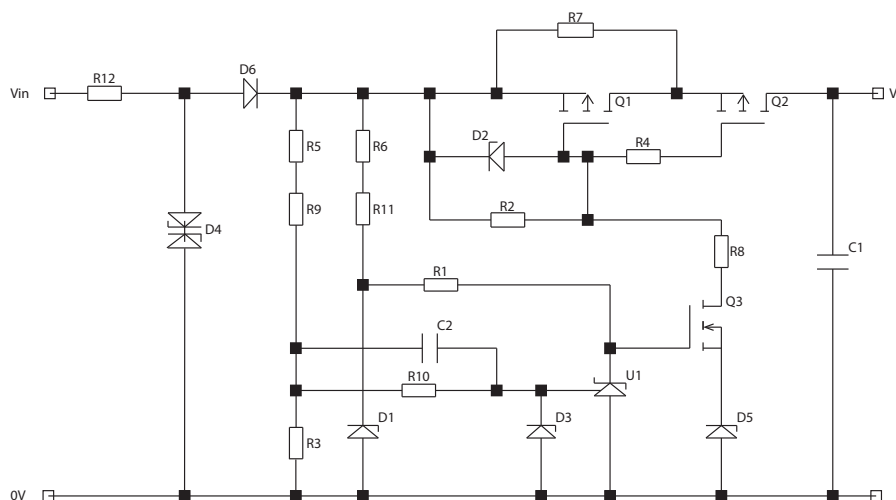

This circuit has been evaluated successfully over temperature for nominal 110 VDC input worst case 3.5 Vnom surge as specified in RIA12. Waveforms obtained are shown in Figures 3. Suggested component values for 110V input are given in Table 4.

Figure 3 – Response to 3.5 x Vnom surge with circuit of Figure 2

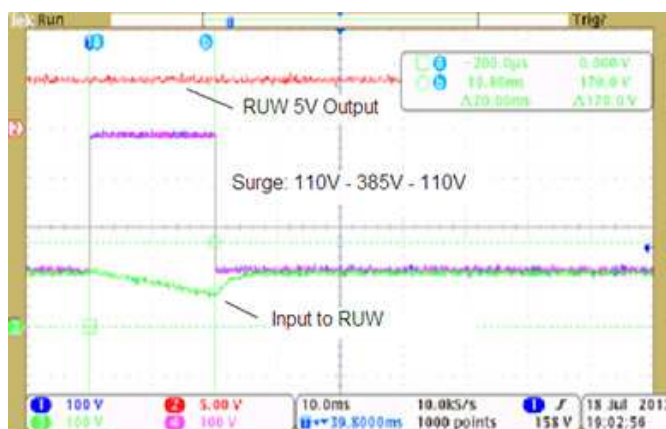

SURGE SUPPRESSION (continued)

TABLE 4. SUGGESTED SURGE LIMITER COMPONENTS 110VDC NOMINAL

Ref	Description	Ref	Description	Ref	Description	Ref	Description
C1	CAPACITOR 47uF 200V	D5	DIODE, ZENER, 2.7V, 0.5W, DO-35	R2, R8	RESISTOR, CARBON FILM, 100K, 0.25W, 5%	R7	RESISTOR, SURGE, 33R, 2W, 250V, 5%
C2	CAPACITOR, DISC, 100V, 390PF	D6	DIODE, 3A, 600V	R3	RESISTOR, 10K, 0.25W, 1%	R9	RESISTOR, 220K, 0.25W, 1%
D1, D2	DIODE, ZENER, 15V, 1.3W, 5%, DO41	Q1, Q2	MOSFET, P, TO-220	R4	RESISTOR, 0.25W 5% 5K6	R10	RESISTOR, CARBON FILM, 1K, 0.25W, 5%
D3	DIODE, ZENER, 5.1V, 500MW, DO-35	Q3	MOSFET, N CH, 500V, 0.5A, TO92	R5	RESISTOR, 0.25W 1% 430K	R12	RESISTOR, SURGE, 10R, 2W, 250V, 5%
D4	DIODE, TVS, 440V, 1.5KW	R1	RESISTOR, CARBON FILM, 4K7, 0.25W, 5%	R6, R11	RESISTOR, 0.25W 1% 36K	U1	SHUNT REG ADJ +2.5/36V, TO92-3, 431

EMC FILTERING AND SPECTRA

FILTERING

The module includes a basic level of filtering, sufficient for many applications. Where lower noise levels are desired, filters can easily be added to achieve any required noise performance. A DC/DC converter generates noise in two principle forms: that which is radiated from its body and that conducted on its external connections. There are three separate modes of conducted noise: input differential, output differential and input-output.

This last appears as common mode at the input and the output, and cannot therefore be removed by filtering at the input or output alone. The first level of filtering is to connect capacitors between input and output returns, to reduce this form of noise. It typically contains high harmonics of the switching frequency, which tend to appear as spikes on surrounding circuits. The voltage rating of this capacitor must match the required isolation voltage. (Due to the great variety in isolation voltage and required noise performance, this capacitor has not been included within the converter.)

Input ripple is a voltage developed across the internal Input decoupling capacitor. It is therefore measured with a defined supply source impedance. Although simple series inductance will provide filtering, on its own it can degrade the converter stability. A shunt capacitor is therefore recommended across the converter input terminals, so that it is fed from a low impedance.

If no filtering is required, the inductance of long supply wiring could also cause a problem, requiring an input decoupling capacitor for stability. An electrolytic type will perform well in these situations. The input-output filtering is performed by the common-mode choke on the primary. This could be placed on the output, but would then degrade the regulation and produce less benefit for a given size, cost, and power loss.

The metallic case of the product is connected internally to output 0V and as such also has reinforced isolation to the input. Tinned tabs on the casing may be soldered to PCB slots to provide mechanical support and extra electrical connection to the casing to optimise EMC shielding. Rail standard EN50155 references EN50121-3-2 for conducted EMI which is less severe than EN55011 so the RUW15 also meets these levels comfortably.

The RUW15 has been evaluated to meet the requirements of EN55011 curve B with an external filter as shown. The limit line shown is quasi peak curve B.

EMC FILTER AND VALUES TO OBTAIN SPECTRA AS SHOWN

The following filter circuit shows the input filter typically required to meet CISPR22 Quasi-Peak Curve B.

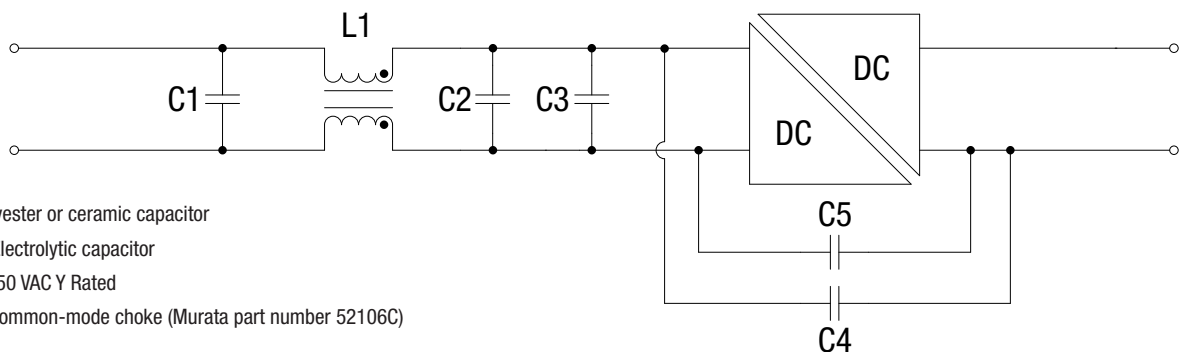

- C1, C3** 1 μ F Polyester or ceramic capacitor
- C2** 100 μ F Electrolytic capacitor
- C4 & C5** 4.7 nF 250 VAC Y Rated
- L1** 4.7 μ H Common-mode choke (Murata part number 52106C)

EMC FILTERING AND SPECTRA

RUW15SL05C

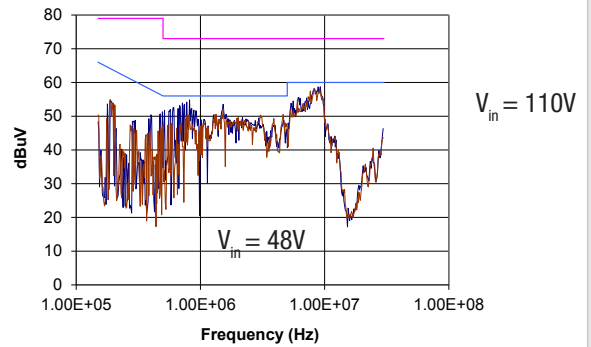
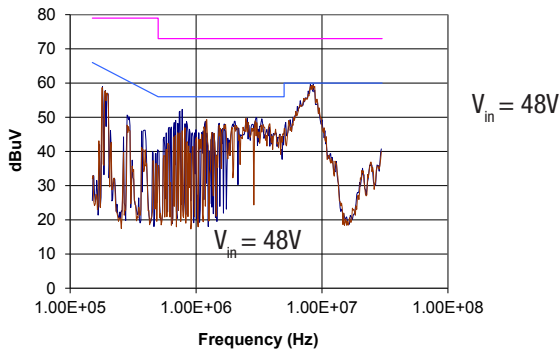

RUW15SL05HC

$V_{in} = 48V$

$V_{in} = 110V$

RUW15SL12C

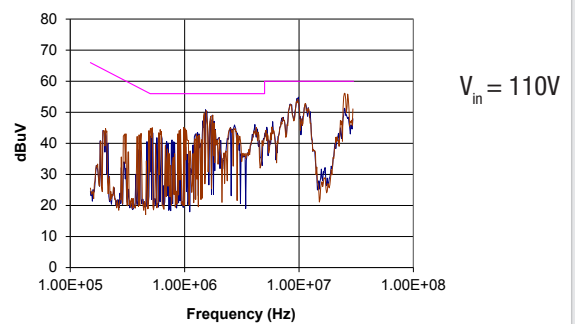
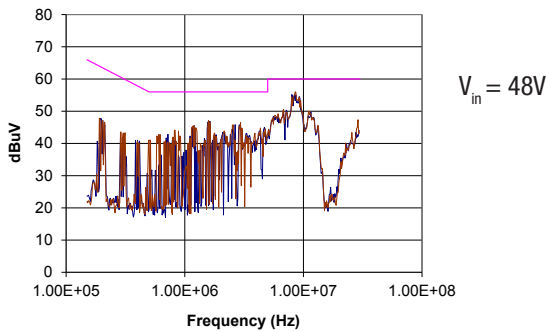

RUW15SL12HC

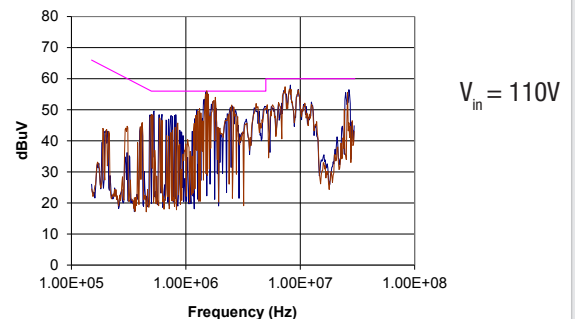
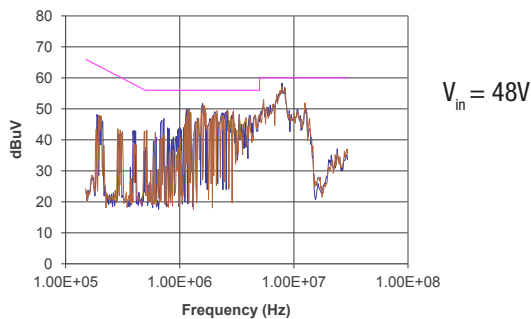

EMC FILTERING AND SPECTRA

RUW15SL24C

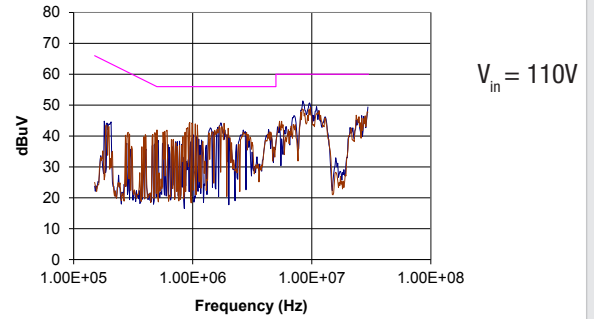
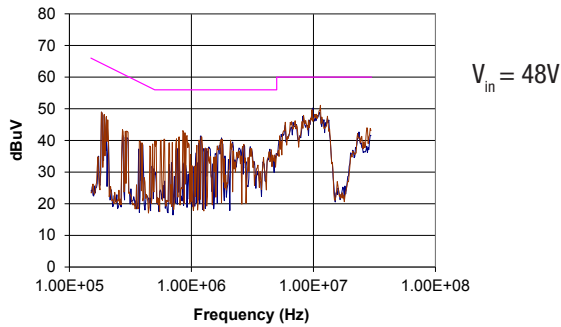

RUW15SL24HC

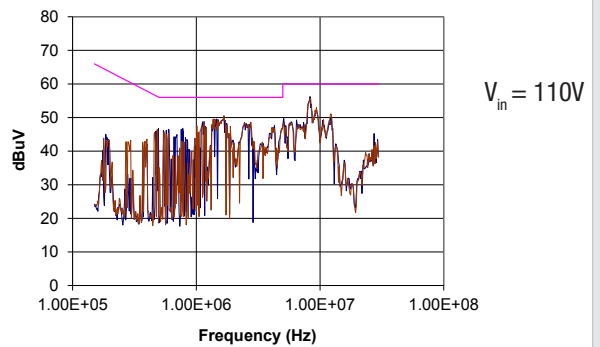
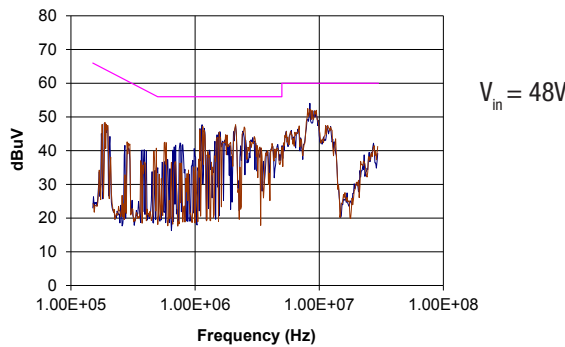

THERMAL DERATING GRAPHS

RUW15SL05C

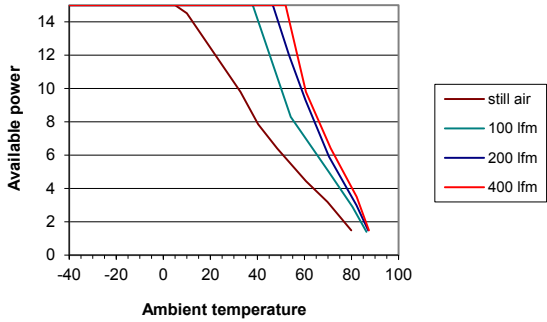

RUW15SL05HC

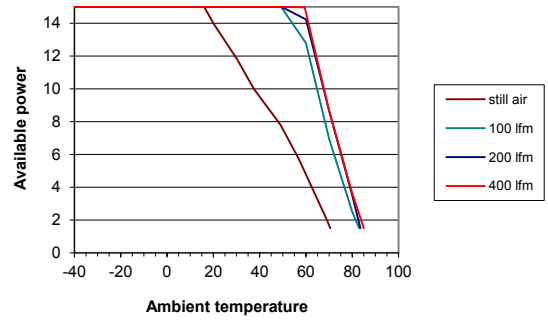

RUW15SL24C

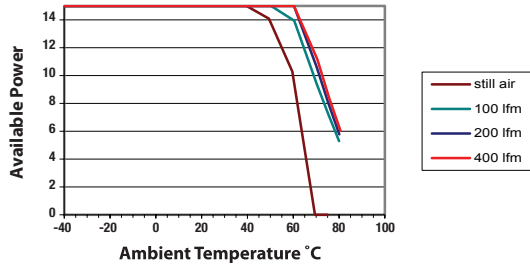

RUW15SL24HC

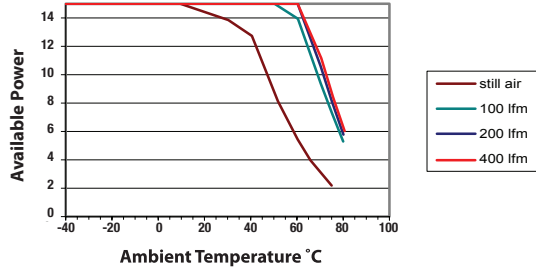

RUW15SL24C

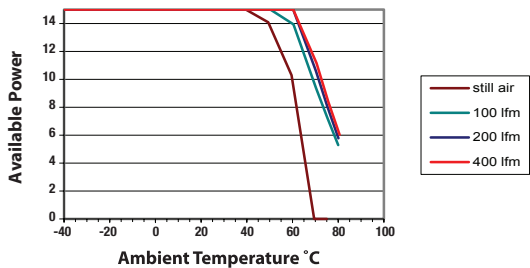

RUW15SL24HC

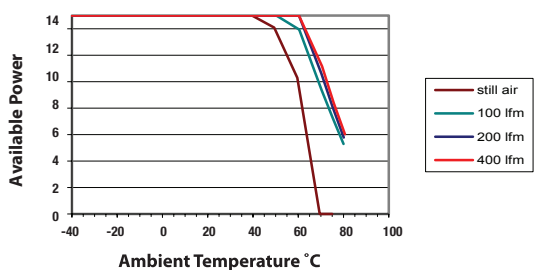

EFFICIENCY GRAPHS

RUW15SL05C

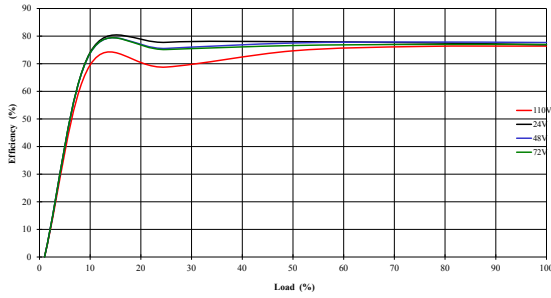

RUW15SL05HC

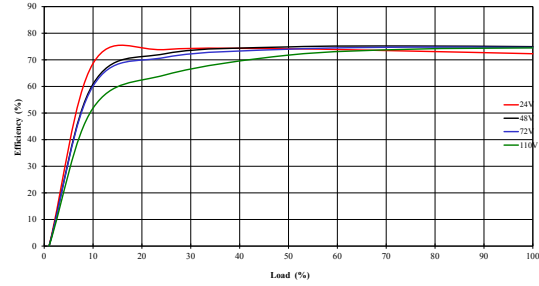

RUW15SL12C

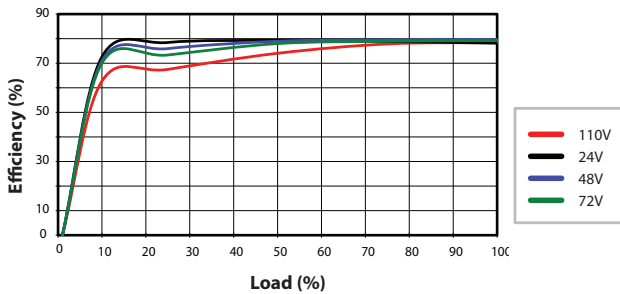

RUW15SL12HC

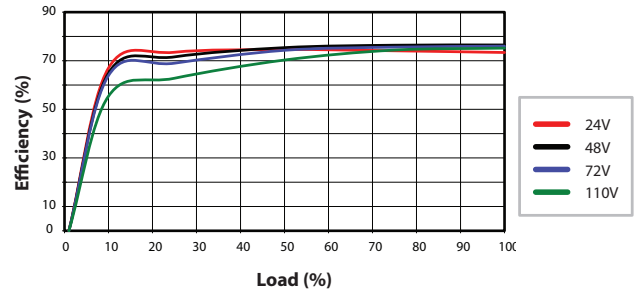

RUW15SL24C

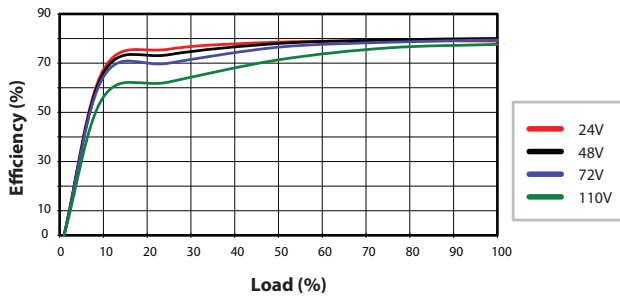

RUW15SL24HC

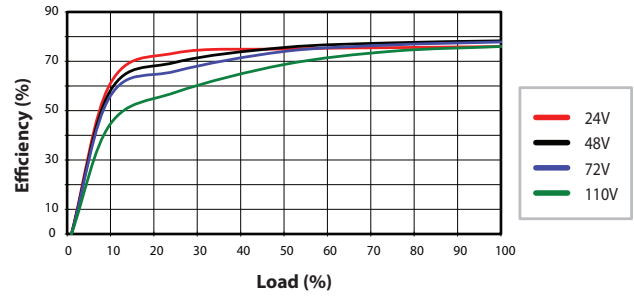

PACKAGE SPECIFICATONS

Mechanical Dimensions

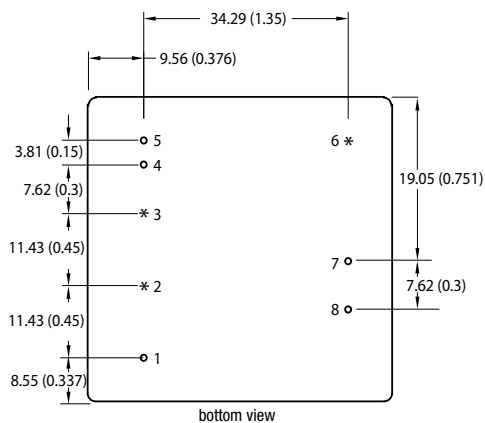
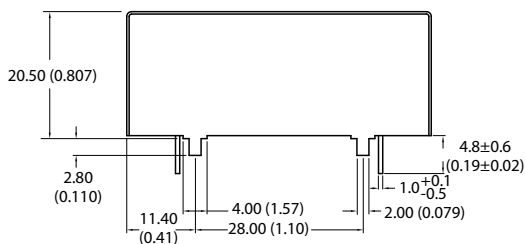
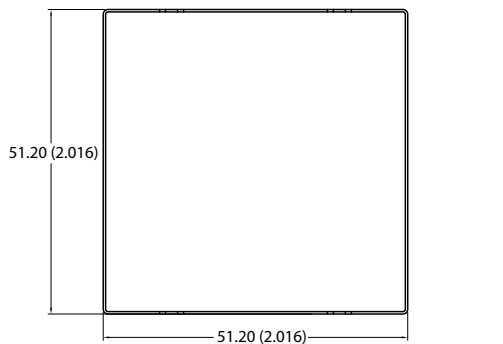

*Optional pins

All dimensions in mm ±0.5 (inches ±0.02) unless otherwise specified.

Weight: 105g Typ.

PIN CONNECTIONS

Pin	Function
1	REMOTE ON/OFF†
2	-V _{INT} *
3	+V _{INT} *
4	-V _{IN}
5	+V _{IN}
6	PF/DC OK*
7	+V _{OUT}
8	-V _{OUT}

† Remote ON/OFF is referenced to input.

RECOMMENDED FOOTPRINT DETAILS

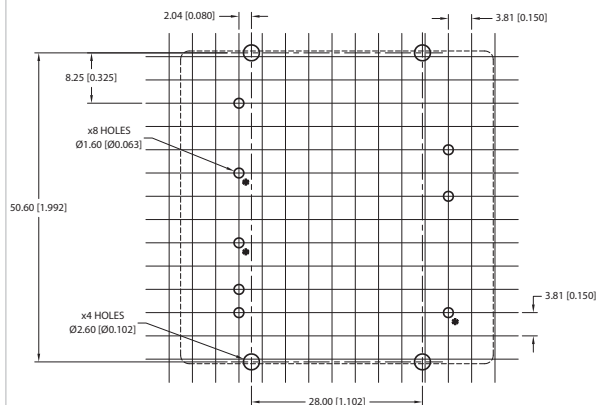

All pins on a 3.81 (0.15) pitch and within ± 0.25 (0.01) of true position. Unless otherwise stated all dimensions are in mm (inches) ± 0.25 (0.01).

Murata Power Solutions, Inc.
11 Cabot Boulevard, Mansfield, MA 02048-1151 U.S.A.
ISO 9001 and 14001 REGISTERED



This product is subject to the following [operating requirements](#) and the [Life and Safety Critical Application Sales Policy](#):
Refer to: <http://www.murata-ps.com/requirements/>

Murata Power Solutions, Inc. makes no representation that the use of its products in the circuits described herein, or the use of other technical information contained herein, will not infringe upon existing or future patent rights. The descriptions contained herein do not imply the granting of licenses to make, use, or sell equipment constructed in accordance therewith. Specifications are subject to change without notice. © 2016 Murata Power Solutions, Inc.