



Chipsmall Limited consists of a professional team with an average of over 10 year of expertise in the distribution of electronic components. Based in Hongkong, we have already established firm and mutual-benefit business relationships with customers from,Europe,America and south Asia,supplying obsolete and hard-to-find components to meet their specific needs.

With the principle of "Quality Parts,Customers Priority,Honest Operation,and Considerate Service",our business mainly focus on the distribution of electronic components. Line cards we deal with include Microchip,ALPS,ROHM,Xilinx,Pulse,ON,Everlight and Freescale. Main products comprise IC,Modules,Potentiometer,IC Socket,Relay,Connector.Our parts cover such applications as commercial,industrial, and automotives areas.

We are looking forward to setting up business relationship with you and hope to provide you with the best service and solution. Let us make a better world for our industry!



Contact us

Tel: +86-755-8981 8866 Fax: +86-755-8427 6832

Email & Skype: info@chipsmall.com Web: www.chipsmall.com

Address: A1208, Overseas Decoration Building, #122 Zhenhua RD., Futian, Shenzhen, China



Surface Mount Power

RC Series: carbon composition (1/4 & 1/2 watt)
 RC Series: ceramic composition (above 1/2 watt)
 RF Series: metal film
 RW Series: wirewound
 RP Series: power film
 RM Series: high voltage thick film

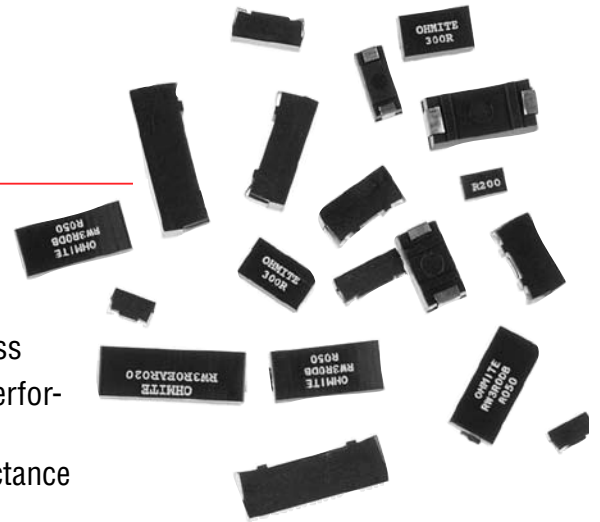
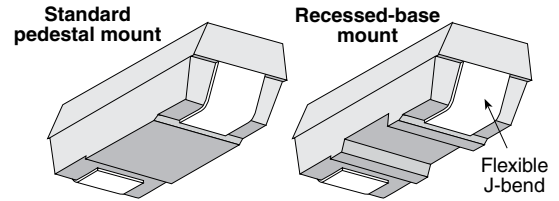

FEATURES

- Tolerance 1%, 5%, 10%, depending on construction
- Twelve wattage ratings
- Seven package sizes
- Two mounting designs to accommodate your soldering process
- Five power resistor technologies to optimize your operating performance:
 1. Carbon and Ceramic composition for surge and low inductance
 2. Metal film for high ohmic value and low T.C.
 3. Wire element for inrush current combined with low ohmic values. Resistance values as low as 0.005Ω
 4. Power film for high ohmic value and high wattage
 5. High Voltage thick film for high voltage applications
- Flexible J-bend terminations
- Working Temperature Range: -55°C to +150°C

SERIES SPECIFICATIONS

Part Number	Power (watts)*	Maximum voltage	1% tol.	Resistance range 5% tol.	10% tol.	Temp. Coefficient 0.1Ω-1Ω	10Ω+	Dielectric Withstanding	Tape Size 13" reels	Quantity per reel
RC0S2CA	0.25	250	—	—	2.2Ω-5.6M	—	±400	±400	1000V	16mm 1500
RC0R5DB	0.50	350	—	—	2.2Ω-20M	—	±400	±400	1000V	24mm 1000
RW0S6BB	0.6	50	0.010Ω-1K	0.005Ω-1K	—	±90	±50	±20	1000V	12mm 2500
RF0S8BA	0.8	200	1Ω-5M	—	—	—	±100	±100	1000V	12mm 2000
RW1S0BA	1.0	50	0.005Ω-1K	0.005Ω-1K	—	±90	±50	±20	1000V	12mm 2000
RF1S0CA	1.0	350	10Ω-1M	1Ω-10M	—	—	±200	±100	1000V	16mm 1500
RC1R0EA	1.0	500	3.3-100K (10% tol only)			—	—	-1300	1000V	32mm 750
RP1S3CA	1.25	350	—	1Ω-1M	—	—	±250	±250	1000V	16mm 1500
RW1S5CA	1.5	75	0.005Ω-1.5K	0.005Ω-1.5K	—	±90	±250	±250	1000V	16mm 1500
RP1S5CB	1.5	350	—	1Ω-1M	—	—	±250	±250	1000V	16mm 1000
RP1R5CB	—	—	—	—	—	—	—	—	—	—
RW2S0CB	2.0	100	0.005Ω-5K	0.005Ω-5K	—	±90	±50	±20	1000V	16mm 1000
RW2R0CB	—	—	—	—	—	—	—	—	—	—
RP2S0DA	2.0	500	—	1Ω-1M	—	—	±250	±250	1000V	24mm 1000
RP2R0DA	—	—	—	—	—	—	—	—	—	—
RW2S0DA	2.0	100	0.005Ω-5K	0.005Ω-5K	—	±90	±50	±20	1000V	24mm 1000
RW2R0DA	—	—	—	—	—	—	—	—	—	—
RP2R5DB	2.5	500	—	1Ω-1M	—	—	±250	±250	1000V	24mm 1000
RW3R0DB	3.0	200	0.005Ω-13K	0.005Ω-13K	—	±90	±50	±20	1000V	24mm 1000
RP3R0EA	3.0	750	—	1Ω-1M	—	—	±250	±250	1000V	32mm 750
RW3R5EA	3.5	350	0.005Ω-25K	0.005Ω-25K	—	±90	±50	±20	1000V	32mm 750
RM0R7EA	0.75	2500	1KΩ-1000M	1KΩ-1000M	—	—	—	±50	1000V	32mm 750

*25°C ambient. E24 values standard; contact Ohmite for custom values.

(continued)

Surface Mount Power

PERFORMANCE DATA

Construction	Temp. cycle (-55°C to 125°C, 1000 cycles)	Load Life (1000 hours at 25°C)	Immersion (260°C for 10 sec.)	Momentary Overload
RC Carbon/Ceramic Comp.	±4.0%+.05Ω	±10.0%+.05Ω	±3.0%+.05Ω	6.3x rated power for 5 sec.
RF Metal Film	±0.5%+.05Ω	±0.5%+.05Ω	±0.1%+.05Ω	2x rated power for 0.1 sec.
RW Wirewound	±0.5%+.05Ω	±3.0%+.05Ω	±0.1%+.05Ω	5x rated power for 5 sec.
RP Power Film	±3.0%+.05Ω	±5.0%+.05Ω	±0.5%+.05Ω	2x rated power for 0.1 sec.
RN Wirewound, Non-inductive	±0.5%+.05Ω	±3.0%+.05Ω	±0.1%+.05Ω	5x rated power for 5 sec.
ALL models:	Leaching (260°C Solder immersion, 60 sec.).....			No visible leaching
	Thermal Shock (Units at -55°C, then rated power applied)..			No mechanical damage
	Flammability			UL Material rating, UL94V0

Derating

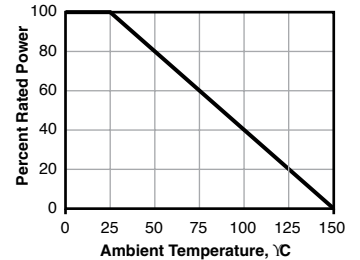

TCR

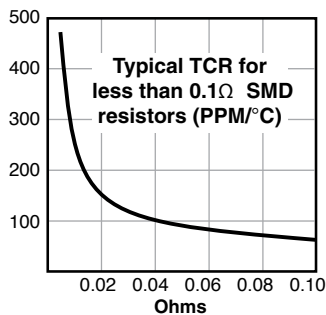

Recommended Solder Profile

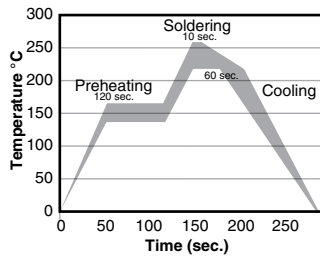

Preheating: 145°C ±15°, max. 120 sec.
Soldering: min. 220°C, max. 60 sec.
Max. Temp.: 260°C ±5°, 10 sec.

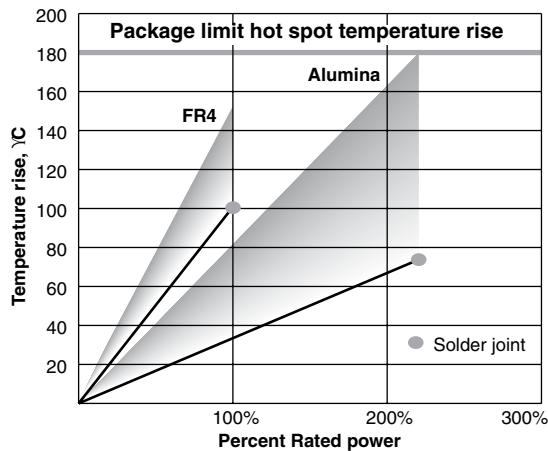

The temperature rise graph data was obtained by a selection of test substrate size and trace width for each resistor size to limit operating temperatures to safe values.

The operating temperature safe rises are either 100°C substrate temperature rise or 180°C package hot spot temperature rise at 25°C ambient.

FR4: 0.062 in. thick; 0.062 in. traces

Alumina: 0.040 in. thick; 0.010 in. traces

Molding material rated at 205°C continuous.

RC SERIES: BAKE PROCEDURE

RC SERIES ONLY

A. Heat Treatment

110°C ±10°C
15 hours

B. Frequency of heat treatment

1 time only

C. Cautions

Solderability: may be affected due to oxidization of lead wire

Resistance value: some units may not completely recover to original value.

Soldering heat: some treated product may have substantial resistance change during soldering operation. It is recommended that parts be tested to evaluate soldering heat effects.

Surface Mount Power

DIMENSIONS

(in./mm)

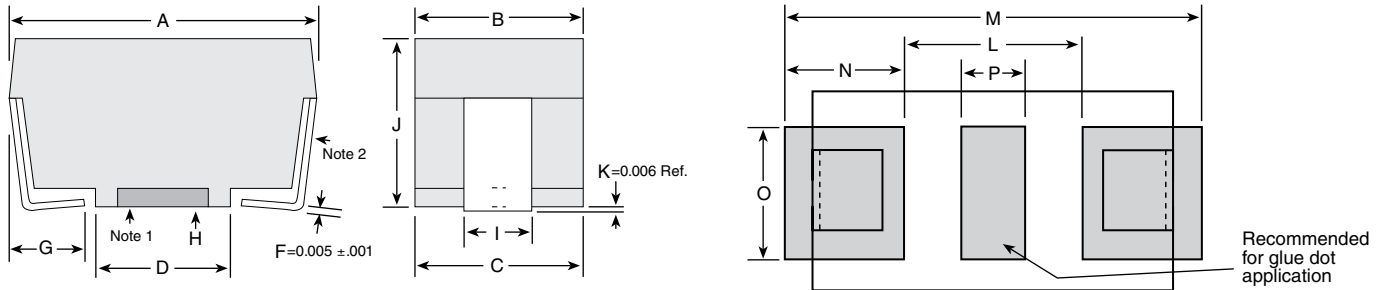

Packages	Package Outline Dimensions					PC Board Land Pattern						
	A	B	C	D	G	I	J	L	M	N	O	P
BA (in.)	0.246±.020	0.136±.005	0.133 REF	0.110±.010	0.047 ±0.020	0.054±.012	0.136±.005	0.150	0.346	0.098	0.126	0.050
(mm)	6.248±.508	3.454±.127	3.378 REF	2.794±.254	1.194 ±0.508	1.372±.305	3.454±.127	3.81	8.79	2.49	3.20	1.27
CA (in.)	0.394±.020	0.159±.005	0.156 REF	0.220±.010	0.062 Nom.	0.078±.012	0.159±.005	0.256	0.524	0.134	0.126	0.060
(mm)	10.008±.508	4.039±.127	3.962 REF	5.588±.254	1.575 Nom.	1.981±.305	4.038±.127	6.50	13.31	3.40	3.20	1.52
CB (in.)	0.407±.020	0.226±.005	0.222 REF	0.260±.010	0.062 Nom.	0.084±.012	0.222±.005	0.276	0.537	0.131	0.126	0.093
(mm)	10.338±.508	5.74±.127	5.639 REF	6.604±.254	1.575 Nom.	2.134±.305	5.639±.127	7.01	13.64	3.33	3.20	2.36
DA (in.)	0.455±.020	0.240±.005	0.236 REF	0.260±.010	0.062 Nom.	0.143±.012	0.226±.005	0.317	0.585	0.134	0.155	0.093
(mm)	11.557±.508	6.096±.127	5.994 REF	6.604±.254	1.575 Nom.	3.632±.305	5.740±.127	8.05	14.86	3.40	3.94	2.36
DB (in.)	0.625±.020	0.273±.005	0.268 REF	0.417±.010	0.062 Nom.	0.143±.012	0.226±.005	0.474	0.742	0.134	0.155	0.093
(mm)	15.875±.508	6.934±.127	6.807 REF	10.592±.254	1.575 Nom.	3.632±.305	5.740±.127	12.040	18.85	3.40	3.94	2.36
EA (in.)	0.811±.020	0.273±.005	0.268 REF	0.572±.010	0.093 Nom.	0.143±.012	0.273±.005	0.611	1.000	0.195	0.155	0.093
(mm)	20.599±.508	6.934±.127	6.807 REF	14.529±.254	2.362 Nom.	3.632±.305	6.934±.127	15.52	25.4	4.95	3.94	2.36
BB (in.)	0.202±.010	0.10±.010	0.095 REF	0.079±.010	0.050 Nom.	0.065±.012	0.135±.005	0.078	0.328	0.125	0.126	0.026
(mm)	5.140±.508	2.54±.127	2.41 REF	2.00±.254	1.280 Nom.	1.640±.305	3.420±.127	1.98	8.33	3.18	3.20	0.66

Note 1: Packages BA and CA are only available with a pedestal base. Packages CB and DA are available in either pedestal or recessed base. Packages DB and EA are only available in a recessed base.

Note 2: Test point is .020 above PCB.

Note 3: Tape and reel dimensions per EIA 481 A except "EA" size which is 12 mm component pitch versus 16mm pitch.

Land pattern dimensions are for reference only

Reel Dimensions

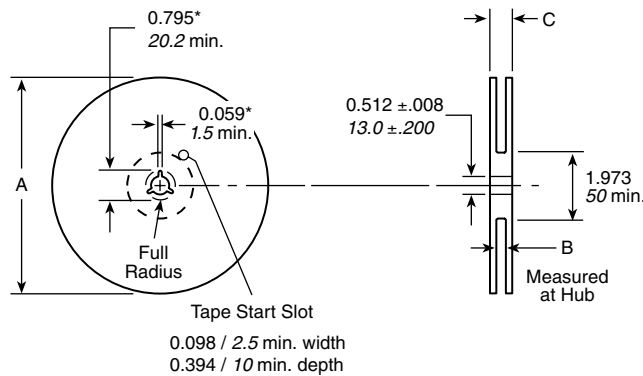

Size	A nom.	B	C max.	Quantity
12mm	13"	0.488" +0.078, -0.00	0.724"	2000 pcs. BA or 2500 pcs. BB
		12.4mm +2.0, -0.0	18.4mm	
16mm	13"	0.646" +0.078, -0.00	0.882"	1500 pcs. CA or 1000 pcs. CB
		16.4mm +2.0, -0.0	22.4mm	
24mm	13"	0.961" +0.078, -0.00	1.196"	1000 pcs. DA or DB
		24.4mm +2.0, -0.0	30.4mm	
32mm	13"	1.276" +0.078, -0.00	1.52"	750 pcs. EA
		32.4mm +2.0, -0.0	38.4mm	

All reels are compatible with major pick-and-place machines and made in accordance with EIA 481 A (except EA size, which is 12mm component pitch versus 16mm pitch).

(continued)

Surface Mount Power

ORDERING INFORMATION

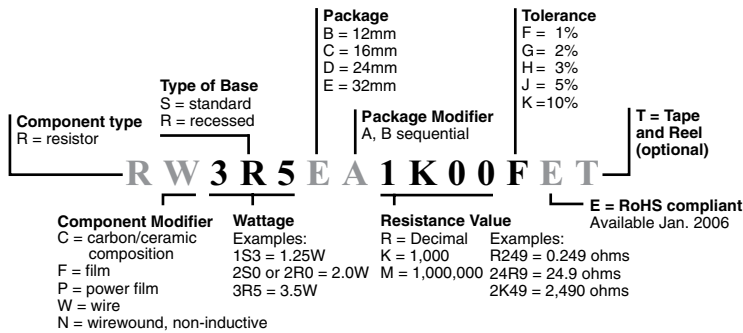

(For example, the part number shown is a wire-wound resistor, 3.5 watt, recessed base, 32mm tape size, first case size [A], 1000 ohms 1% tolerance.)

Standard Part Numbers for Surface Mount Power Resistors

Ohmic value	Part No.	Wirewound										
		Package style	BA	CA	CB	CB	DA	DA	DB	EA	BB	EA
		Base: standard or recessed	S	S	S	R	S	R	R	R	S	R
		Wattage	1.0	1.5	2.0	2.0	2.0	2.0	3.0	3.5	0.6	1.0
	Prefix	RW1S0BA	RW1S5CA	RW2S0CB	RW2R0CB	RW2S0DA	RW2R0DA	RW3R0DB	RW3R5EA	RW0S6BB	RC1R0EA	
	Suffix	Tolerance suffix: F = 1% J = 5% K = 10%										
0.005	R005	J	J		F/J							
0.010	R010	F/J	J	J	F	J	J	J	F			
0.015	R015	F/J	J						F			
0.020	R020	J	J	J	F	J		J	F			
0.025	R025	J										
0.027	R027	J										
0.030	R030	F	J	J				J	F			
0.033	R033	J										
0.036	R036	J										
0.050	R050	F/J	J	J	J	F	J	J	F			
0.056	R056	J										
0.075	R075	J								F		
0.080	R080	J						J				
0.100	R100	F/J	J	J	J	F	J	J	F			
0.150	R150	J	J	J	J							
0.200	R200	J	J					J				
0.220	R220	J	J									
0.240	R240	J	J							F		
0.300	R300	J		J								
0.330	R330	J		J								
0.400	R040	J										
0.400	R400	J		J								
0.470	R470	J	J	J		J				F		
0.500	R500	J	J		J			J				
0.750	R750	J								F		
1.00	1R00	F/J	J	J		J	J			F		
2.00	2R00	J	J							F		

Ohmic value	Part No.	Wirewound										
		Package style	BA	CA	CB	CB	DA	DA	DB	EA	BB	EA
		Base: standard or recessed	S	S	S	R	S	R	R	R	S	R
		Wattage	1.0	1.5	2.0	2.0	2.0	2.0	3.0	3.5	0.6	1.0
	Prefix	RW1S0BA	RW1S5CA	RW2S0CB	RW2R0CB	RW2S0DA	RW2R0DA	RW3R0DB	RW3R5EA	RW0S6BB	RC1R0EA	
	Suffix	Tolerance suffix: F = 1% J = 5% K = 10%										
3.30	3R30										K	
4.70	4R70										K	
5.00	5R00									F		
5.60	5R60	J										
6.80	6R80										K	
7.50	7R50							J	F		K	
10.00	10R0	J	J	J		J			F	F	K	
15.00	15R0	J	J						F	F	K	
20.00	20R0			J								
22.00	22R0										K	
24.90	24R9									F	K	
33.00	33R0									F	K	
36.00	36R0									F	K	
47.00	47R0	J						J	F	F	K	
50.00	50R0											
51.00	51R0	J										
68.00	68R0										K	
82.00	82R0				J							
100.00	100R		J	J						F	K	
120.00	120R		J									
180.00	180R	J										
300.00	300R	J										
470.00	470R					J						
1K	1K00							J			K	
4.7K	4K70			J								
5K	5K00								J			