



Chipsmall Limited consists of a professional team with an average of over 10 year of expertise in the distribution of electronic components. Based in Hongkong, we have already established firm and mutual-benefit business relationships with customers from,Europe,America and south Asia,supplying obsolete and hard-to-find components to meet their specific needs.

With the principle of "Quality Parts,Customers Priority,Honest Operation,and Considerate Service",our business mainly focus on the distribution of electronic components. Line cards we deal with include Microchip,ALPS,ROHM,Xilinx,Pulse,ON,Everlight and Freescale. Main products comprise IC,Modules,Potentiometer,IC Socket,Relay,Connector.Our parts cover such applications as commercial,industrial, and automotives areas.

We are looking forward to setting up business relationship with you and hope to provide you with the best service and solution. Let us make a better world for our industry!



Contact us

Tel: +86-755-8981 8866 Fax: +86-755-8427 6832

Email & Skype: info@chipsmall.com Web: www.chipsmall.com

Address: A1208, Overseas Decoration Building, #122 Zhenhua RD., Futian, Shenzhen, China



The S-5813A/5814A Series is a family of high-precision temperature sensor ICs on a single chip with a linear output voltage for temperature changes.

Each chip is composed of a temperature sensor, a constant current circuit, and an operational amplifier.

The operating ambient temperature is from -40°C to $+100^{\circ}\text{C}$. These devices have much better linearity than other temperature sensors such as thermistors, and can be used for a wide range of temperature control applications.

■ Features

- Temperature accuracy
 - S-5813A Series : $\pm 5.0^{\circ}\text{C}$ (-30°C to $+100^{\circ}\text{C}$)
 - S-5814A Series : $\pm 2.5^{\circ}\text{C}$ (-30°C to $+100^{\circ}\text{C}$)
- Linear output voltage
 - $-11.04\text{ mV}/^{\circ}\text{C}$ typ.
 - $T_a = -30^{\circ}\text{C}$: 2.582 V typ.
 - $T_a = +30^{\circ}\text{C}$: 1.940 V typ.
 - $T_a = +100^{\circ}\text{C}$: 1.145 V typ.
- Nonlinearity
 - $\pm 0.5\%$ typ. (-20°C to $+80^{\circ}\text{C}$)
- Wide power supply voltage operation
 - $V_{DD} = 2.4\text{ V}$ to 10.0 V ($+25^{\circ}\text{C}$)
- Low current consumption
 - $4.0\text{ }\mu\text{A}$ typ. ($+25^{\circ}\text{C}$)
- Built-in operational amplifier
- Output voltage referred to V_{SS}
- Lead-free (Sn 100%), halogen-free

■ Applications

- Compensation of high-frequency circuits such as cellular phones and radio equipment
- Compensation of oscillation frequency in crystal oscillator
- LCD contrast compensation
- Compensation of amplifier gain
- Compensation of auto focus circuits
- Temperature detection in battery management
- Overheating prevention for charged batteries or halogen lights

■ Package

- SNT-4A

■ Block Diagram

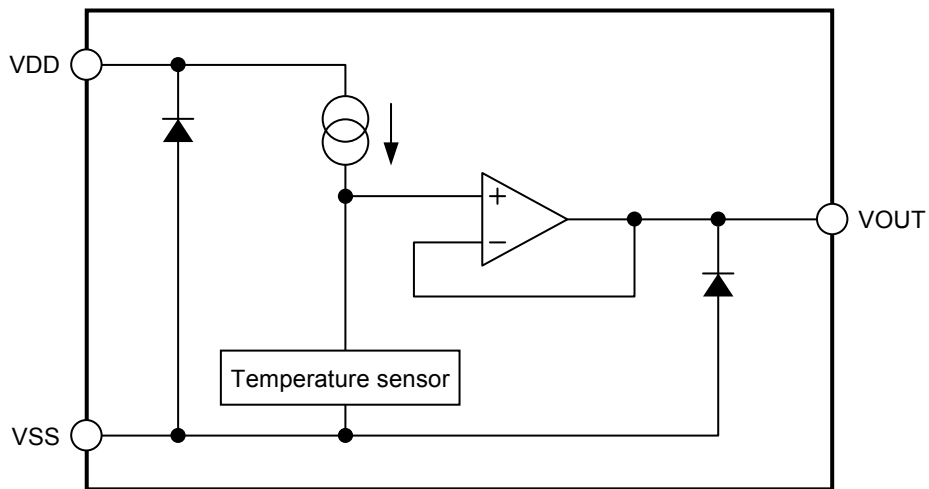
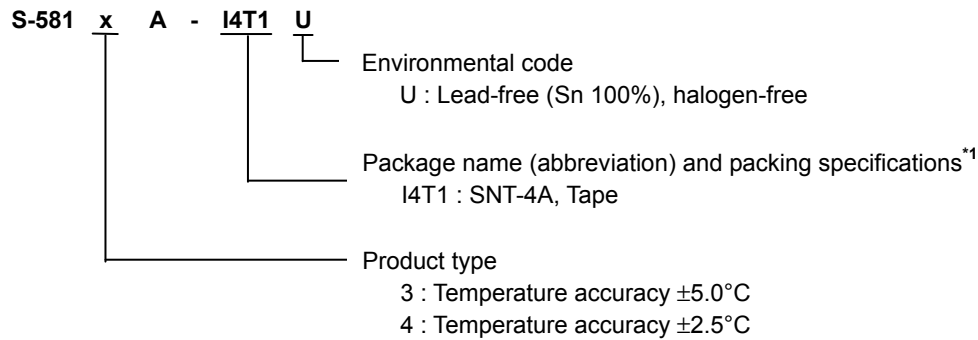

Figure 1

■ Product Name Structure

Users can select the product type for the S-5813A/5814A Series. Refer to “1. Product name” regarding the contents of product name, “2. Package” regarding the package drawings, “3. Product name list” regarding details of the product name.

1. Product name



*1. Refer to the tape drawing.

2. Package

Package Name	Drawing Code			
	Package	Tape	Reel	Land
SNT-4A	PF004-A-P-SD	PF004-A-C-SD	PF004-A-R-SD	PF004-A-L-SD

3. Product name list

Table 1

Product Name	Temperature Accuracy
S-5813A-I4T1U	$\pm 5.0^{\circ}\text{C}$
S-5814A-I4T1U	$\pm 2.5^{\circ}\text{C}$

■ Pin Configuration

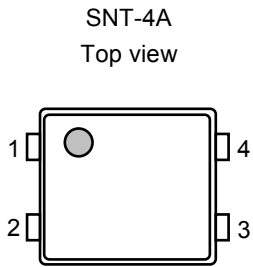

Figure 2

Table 2

Pin No.	Pin Name	Pin Description
1	VSS	GND pin
2	VDD	Power supply pin
3	VOUT	Output voltage pin
4	NC*1	No connection

*1. The NC pin is electrically open.

The NC pin can be connected to the VDD pin or the VSS pin.

■ Absolute Maximum Ratings

Table 3

(Ta = +25°C unless otherwise specified)

Item	Symbol	Absolute Maximum Rating	Unit
Power supply voltage	V _{DD}	V _{SS} – 0.3 to V _{SS} + 12.0	V
Output voltage	V _{OUT}	V _{SS} – 0.3 to V _{DD} + 0.3	V
Power dissipation	P _D	140 (When not mounted on board)	mW
		300*1	mW
Operating ambient temperature	T _{opr}	–40 to +100	°C
Storage temperature	T _{stg}	–40 to +125	°C

*1. When mounted on board
[Mounted board]

- (1) Board size : 114.3 mm × 76.2 mm × t1.6 mm
- (2) Board name : JEDEC STANDARD51-7

Caution The absolute maximum ratings are rated values exceeding which the product could suffer physical damage. These values must therefore not be exceeded under any conditions.

■ **Electrical Characteristics**

1. S-5813A Series

Table 4
(Ta = +25°C, V_{DD} = 5.0 V, I_{OUT} = 0 A unless otherwise specified)

Item	Symbol	Conditions	Min.	Typ.	Max.	Unit	Test Circuit
Power supply voltage	V _{DD}	–	2.40	–	10.00	V	1
		Ta = –20°C to +100°C	2.65	–	10.00	V	1
		Ta = –30°C to +100°C	2.90	–	10.00	V	1
Output voltage	V _{OUT}	Ta = –30°C	2.528	2.582	2.636	V	1
		Ta = +30°C	1.886	1.940	1.994	V	1
		Ta = +100°C	1.091	1.145	1.199	V	1
Temperature sensitivity	V _{SE}	Ta = –30°C to +100°C	–11.31	–11.04	–10.77	mV/°C	–
Nonlinearity	ΔN _L	Ta = –20°C to +80°C	–	±0.5	–	%	–
Operating temperature range	T _{opr}	–	–40	–	100	°C	–
Current consumption	I _{DD}	–	–	4.0	8.0	μA	1
Line regulation	ΔV _{OUT1}	V _{DD} = 2.4 V to 10.0 V	–	–	0.05	%/V	2
Load regulation*1	ΔV _{OUT2}	I _{OUT} = 0 μA to 200 μA	–	–	1.0	mV	2

*1. Do not flow current into the output voltage pin.

2. S-5814A Series

Table 5
(Ta = +25°C, V_{DD} = 5.0 V, I_{OUT} = 0 A unless otherwise specified)

Item	Symbol	Conditions	Min.	Typ.	Max.	Unit	Test Circuit
Power supply voltage	V _{DD}	–	2.40	–	10.00	V	1
		Ta = –20°C to +100°C	2.65	–	10.00	V	1
		Ta = –30°C to +100°C	2.90	–	10.00	V	1
Output voltage	V _{OUT}	Ta = –30°C	2.555	2.582	2.609	V	1
		Ta = +30°C	1.913	1.940	1.967	V	1
		Ta = +100°C	1.118	1.145	1.172	V	1
Temperature sensitivity	V _{SE}	Ta = –30°C to +100°C	–11.31	–11.04	–10.77	mV/°C	–
Nonlinearity	ΔN _L	Ta = –20°C to +80°C	–	±0.5	–	%	–
Operating temperature range	T _{opr}	–	–40	–	100	°C	–
Current consumption	I _{DD}	–	–	4.0	8.0	μA	1
Line regulation	ΔV _{OUT1}	V _{DD} = 2.4 V to 10.0 V	–	–	0.05	%/V	2
Load regulation*1	ΔV _{OUT2}	I _{OUT} = 0 μA to 200 μA	–	–	1.0	mV	2

*1. Do not flow current into the output voltage pin.

■ Test Circuits

1.

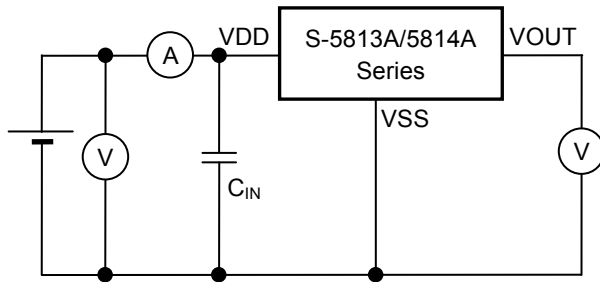

Figure 3

2.

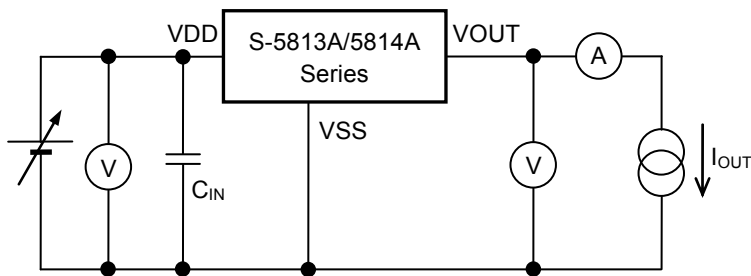

Figure 4

■ Explanation of Terms

1. Output voltage (V_{OUT})

V_{OUT} indicates the output voltage at $T_a = -30^\circ\text{C}$, $T_a = +30^\circ\text{C}$, and $T_a = +100^\circ\text{C}$.

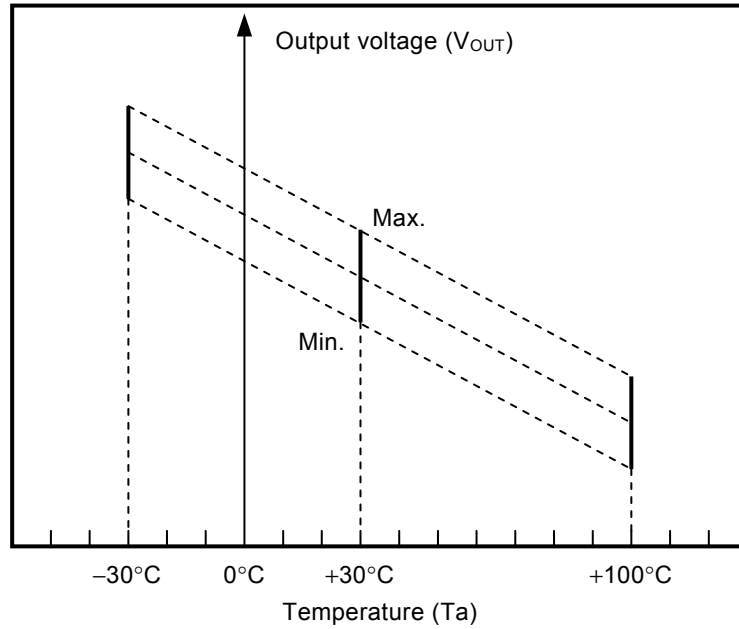

Figure 5

2. Temperature sensitivity (V_{SE})

V_{SE} indicates the temperature coefficient of the output voltage calculated using the output voltage at $T_a = -30^\circ\text{C}$ and $T_a = +100^\circ\text{C}$.

V_{SE} is calculated using the following formula.

$$V_{SE} = \frac{[V_{OUT}^{*1} - V_{OUT}^{*2}]}{130^{*3}}$$

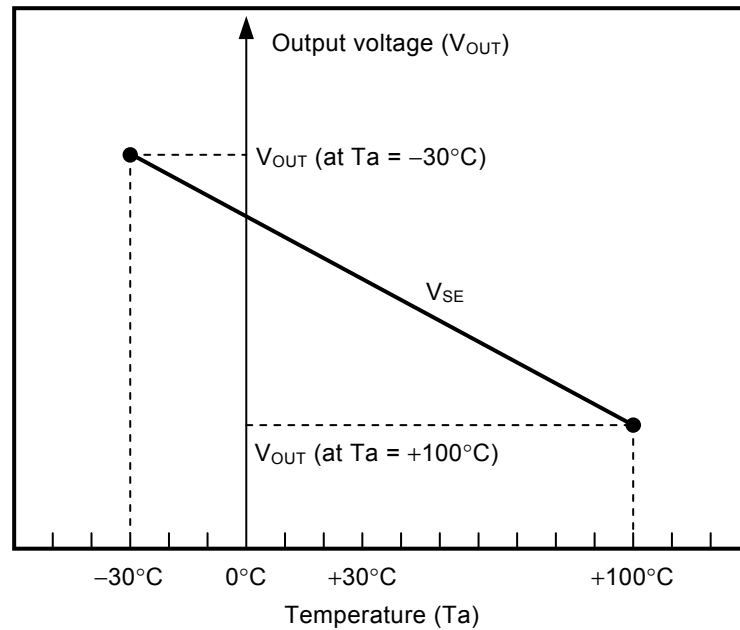

Figure 6

- *1. V_{OUT} value [V] at $T_a = +100^\circ\text{C}$.
- *2. V_{OUT} value [V] at $T_a = -30^\circ\text{C}$.
- *3. The difference of the temperature [$^\circ\text{C}$] from $T_a = +100^\circ\text{C}$ to $T_a = -30^\circ\text{C}$.

3. Nonlinearity (ΔN_L)

ΔN_L indicates the nonlinearity of the output voltage and is defined as the difference of the characteristic curve of the output voltage and the approximated straight line shown below.

ΔN_L is calculated using the following formula.

$$\Delta N_L = \frac{a^{*1}}{b^{*2}} \times 100$$

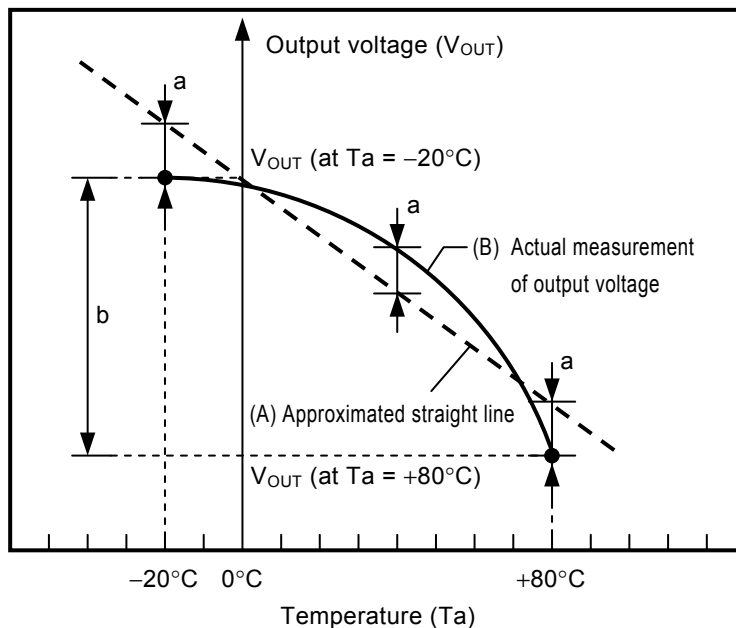

- *1. The maximum deviation of the actual measurement of output voltage (B) and an approximated straight line (A) in temperature within -20°C to $+80^{\circ}\text{C}$. (An approximated straight line is taken as the straight line when the "a" becomes the minimum.)
- *2. The difference of the output voltage within -20°C to $+80^{\circ}\text{C}$.

Figure 7

4. Line regulation (ΔV_{OUT1})

ΔV_{OUT1} indicates the output voltage dependency of the input voltage. That is, the values express how the output voltage changes, when input voltage is changed under the condition that output current is fixed.

5. Load regulation (ΔV_{OUT2})

ΔV_{OUT2} indicates the output voltage dependency of the output current. That is, the values express how the output voltage changes, when output current is changed under the condition that input voltage is fixed.

■ Precautions

- Wiring patterns for the VDD pin, VSS pin, and VOUT pin should be designed to hold low impedance.
- In this IC, if load capacitance of the VOUT pin is large, VOUT pin voltage may oscillate. It is recommended not to use the external capacitor between the VOUT and VSS pin. When using an external capacitor, mount it near the VOUT pin. When connecting an A/D converter etc. to the VOUT pin, the input pin capacitance of the A/D converter and the parasitic capacitance component between wires are included as load capacitance. To prevent oscillation, it is recommended to use the following output load condition.

Load capacitance of VOUT pin (C_L) : 2.2 μ F or less

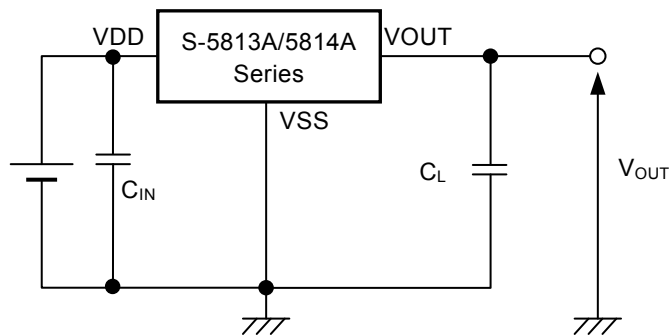

Figure 8

Caution The above connection diagram and constant will not guarantee successful operation. Perform through evaluation using the actual application to set the constant.

- Please do not connect a pull-up resistor to the output voltage pin.
- The application condition for input voltage, output voltage and load voltage must not exceed the package power dissipation.
- Do not apply an electrostatic discharge to this IC that exceeds the performance ratings of the built-in electrostatic protection circuit.
- SII Semiconductor Corporation claims no responsibility for any disputes arising out of or in connection with any infringement by products including this IC of patents owned by a third party.

■ **Characteristics (Typical Data)**

1. Output voltage (V_{OUT}) vs. Temperature (T_a)

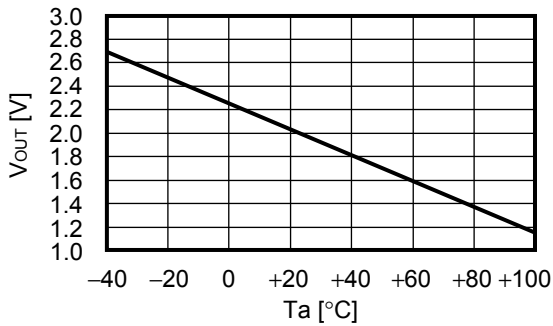

2. Current consumption (I_{DD}) vs. Temperature (T_a)

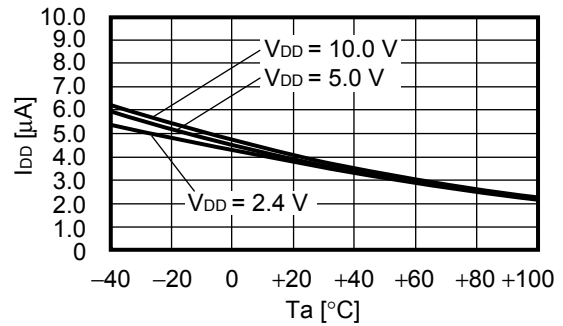

3. Error range of each temperature

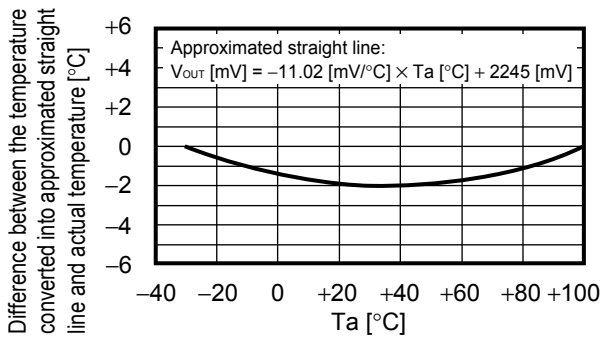

4. Current consumption (I_{DD}) vs. Power supply voltage (V_{DD})

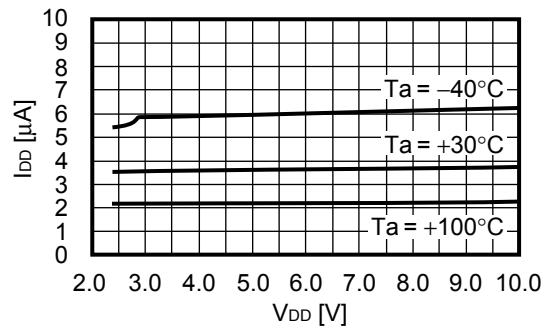

5. Output voltage (V_{OUT}) vs. Power supply voltage (V_{DD})

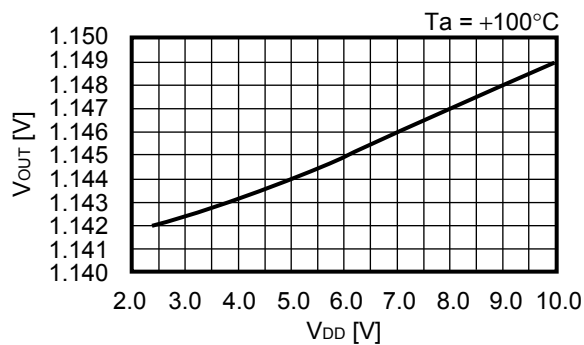
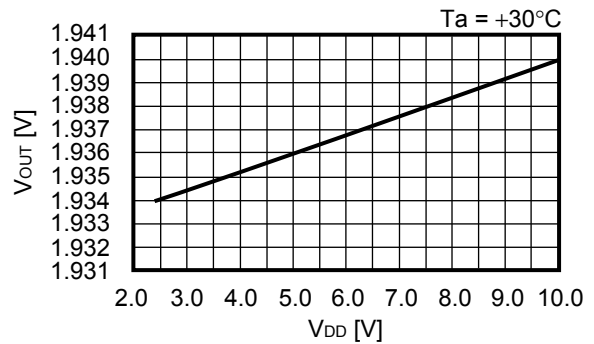
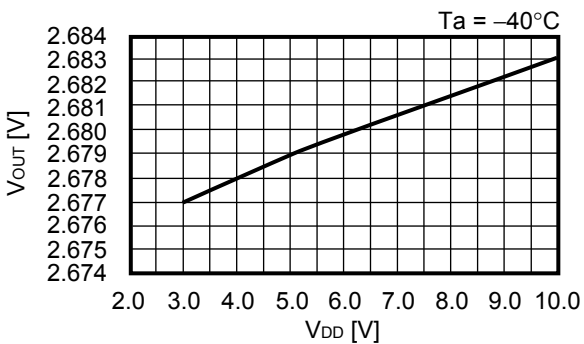

6. Output voltage (V_{OUT}) vs. Load current (I_{OUT})

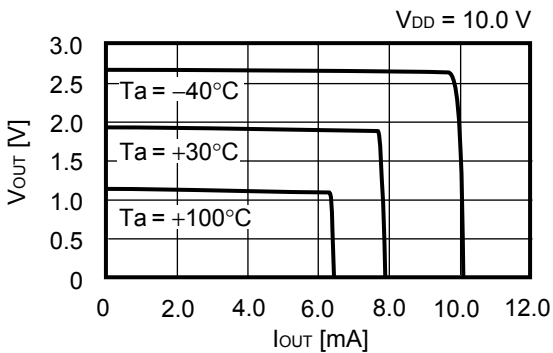
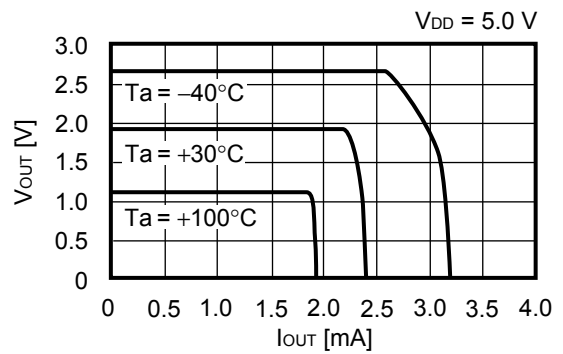
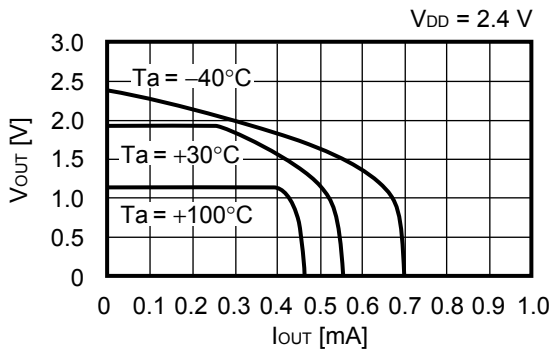

7. Heat response Output voltage (V_{OUT}) vs. Time (t)

When package is put into the air of +100°C from the air of +25°C

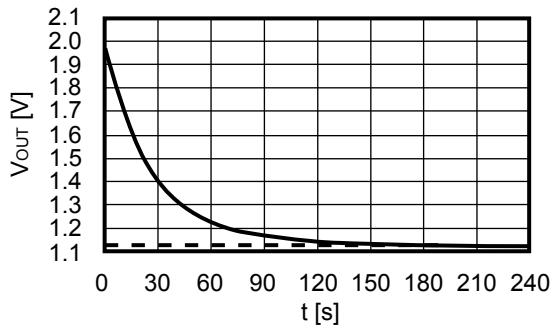

When package is put into the liquid of +100°C from the air of +25°C

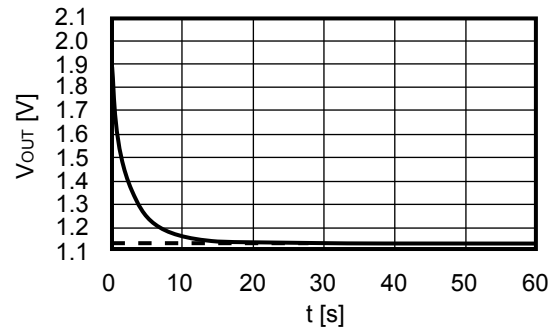

8. Start up response

$T_a = +25^\circ\text{C}$, $C_L = 100\text{ pF}$, $R_L = 10\text{ M}\Omega$

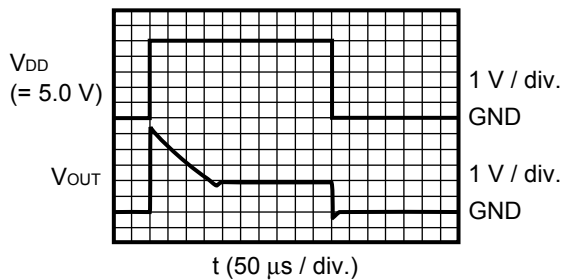

$T_a = +25^\circ\text{C}$, $C_L = 100\text{ pF}$, $R_L = 10\text{ M}\Omega$

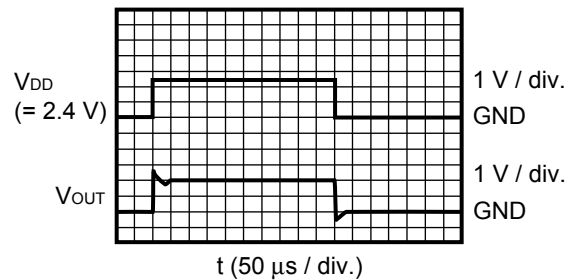

■ **Marking Specification**

1. **SNT-4A**

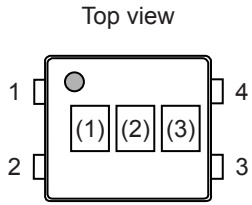

(1) to (3) : Product code (refer to **Product name vs. Product code**)

Product name vs. Product code

Product Name	Product Code		
	(1)	(2)	(3)
S-5813A-I4T1U	D	R	C
S-5814A-I4T1U	D	R	D

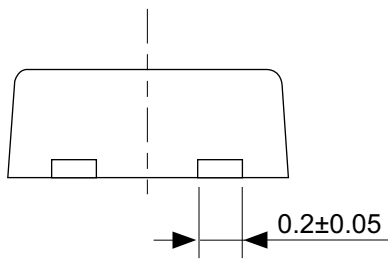
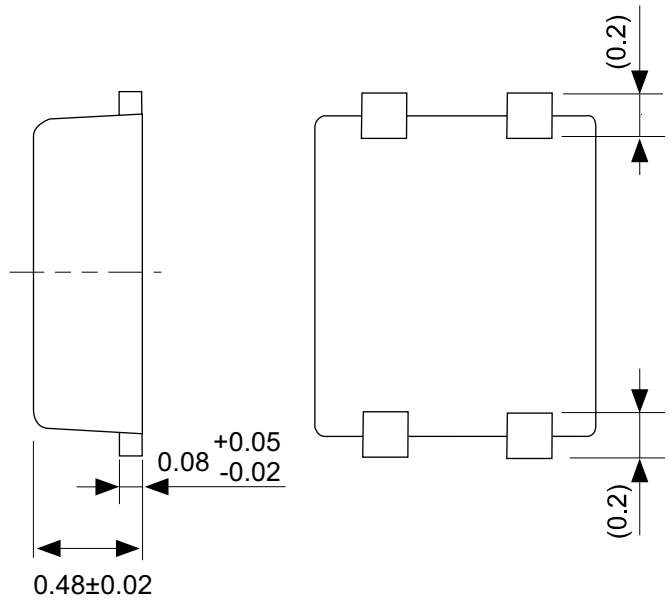
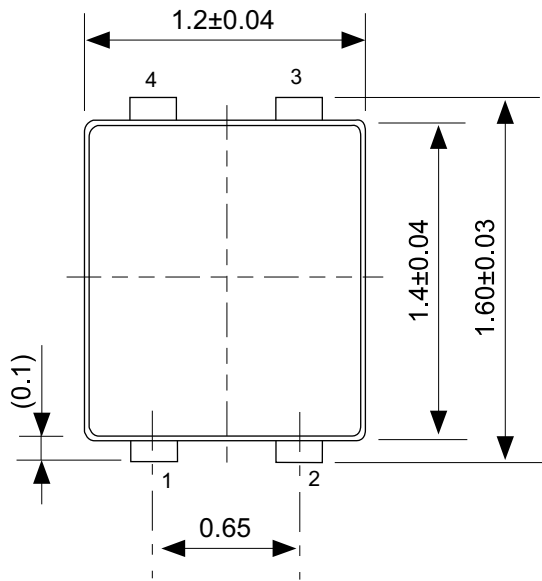

No. PF004-A-P-SD-4.0

TITLE	SNT-4A-A-PKG Dimensions
No.	PF004-A-P-SD-4.0
SCALE	
UNIT	mm
SII Semiconductor Corporation	

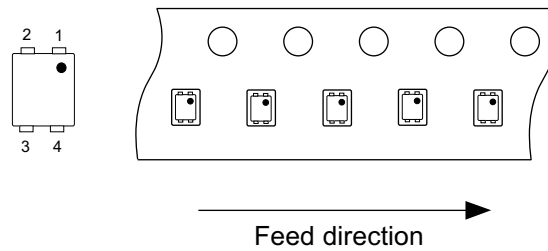
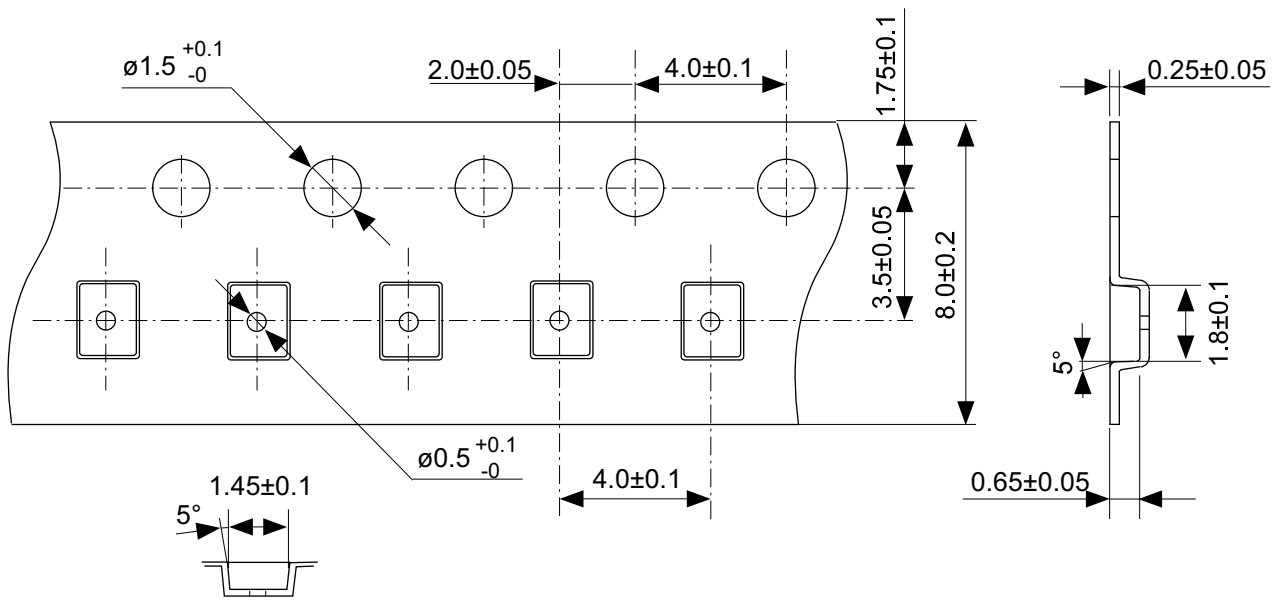

No. PF004-A-C-SD-1.0

TITLE	SNT-4A-A-Carrier Tape
No.	PF004-A-C-SD-1.0
SCALE	
UNIT	mm
SII Semiconductor Corporation	

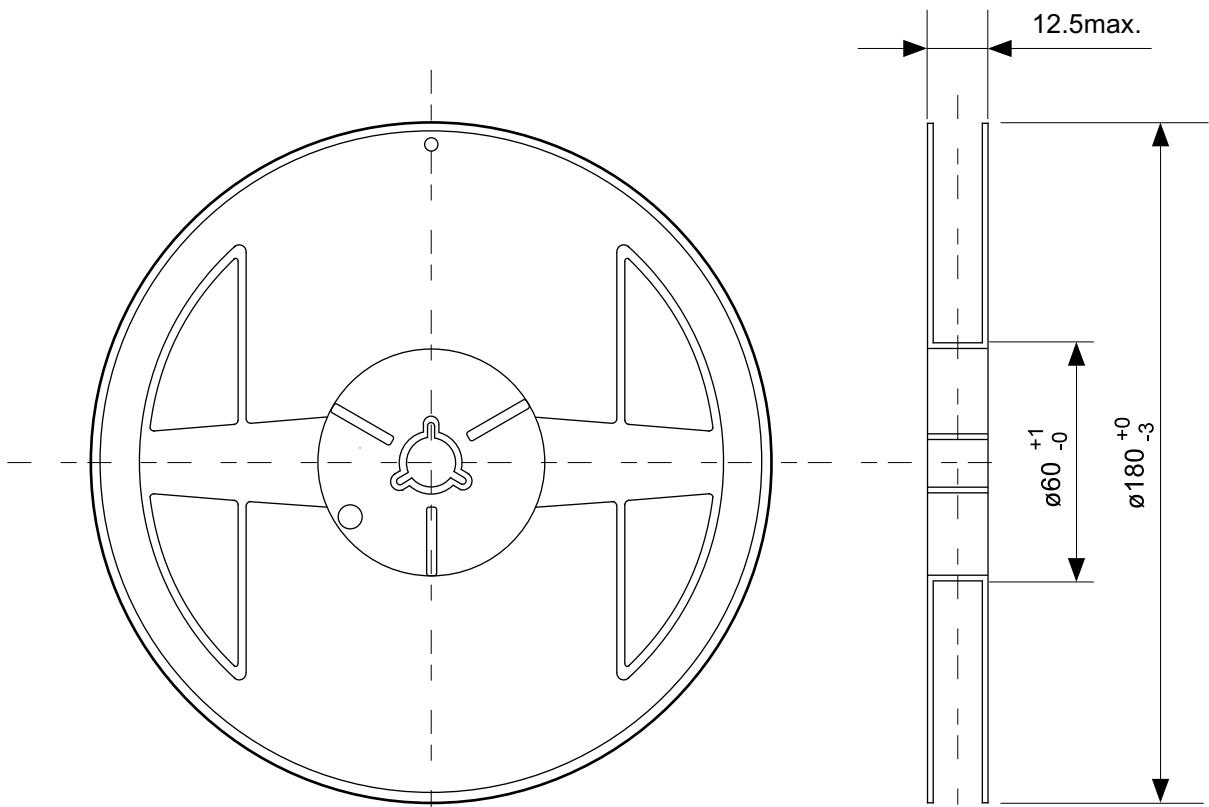

Enlarged drawing in the central part

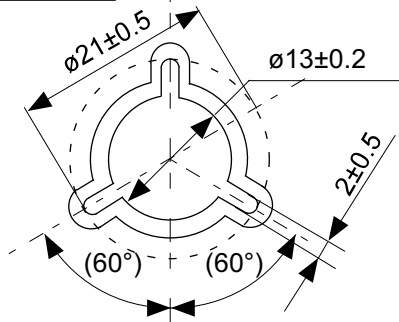

No. PF004-A-R-SD-1.0

TITLE	SNT-4A-A-Reel		
No.	PF004-A-R-SD-1.0		
SCALE		QTY.	5,000
UNIT	mm		
SII Semiconductor Corporation			

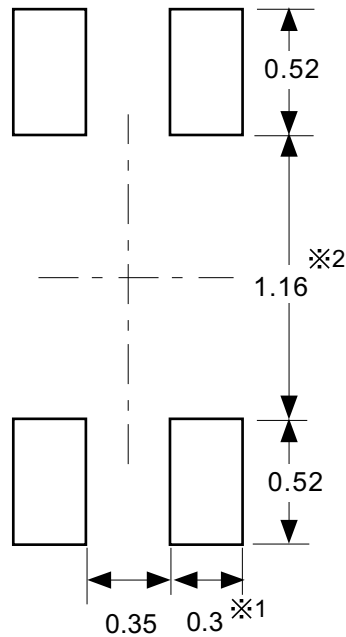

※1. ランドパターンの幅に注意してください (0.25 mm min. / 0.30 mm typ.).

※2. パッケージ中央にランドパターンを広げないでください (1.10 mm ~ 1.20 mm)。

- 注意
1. パッケージのモールド樹脂下にシルク印刷やハンダ印刷などしないでください。
 2. パッケージ下の配線上のソルダーレジストなどの厚みをランドパターン表面から0.03 mm 以下にしてください。
 3. マスク開口サイズと開口位置はランドパターンと合わせてください。
 4. 詳細は "SNTパッケージ活用の手引き" を参照してください。

※1. Pay attention to the land pattern width (0.25 mm min. / 0.30 mm typ.).

※2. Do not widen the land pattern to the center of the package (1.10 mm to 1.20 mm).

- Caution**
1. Do not do silkscreen printing and solder printing under the mold resin of the package.
 2. The thickness of the solder resist on the wire pattern under the package should be 0.03 mm or less from the land pattern surface.
 3. Match the mask aperture size and aperture position with the land pattern.
 4. Refer to "SNT Package User's Guide" for details.

※1. 请注意焊盘模式的宽度 (0.25 mm min. / 0.30 mm typ.).

※2. 请勿向封装中间扩展焊盘模式 (1.10 mm ~ 1.20 mm)。

- 注意
1. 请勿在树脂型封装的下面印刷丝网、焊锡。
 2. 在封装下、布线上的阻焊膜厚度 (从焊盘模式表面起) 请控制在 0.03 mm 以下。
 3. 钢网的开口尺寸和开口位置请与焊盘模式对齐。
 4. 详细内容请参阅 "SNT 封装的应用指南"。

No. PF004-A-L-SD-4.1

TITLE	SNT-4A-A -Land Recommendation
No.	PF004-A-L-SD-4.1
SCALE	
UNIT	mm
SII Semiconductor Corporation	

Disclaimers (Handling Precautions)

1. All the information described herein (product data, specifications, figures, tables, programs, algorithms and application circuit examples, etc.) is current as of publishing date of this document and is subject to change without notice.
2. The circuit examples and the usages described herein are for reference only, and do not guarantee the success of any specific mass-production design.
SII Semiconductor Corporation is not responsible for damages caused by the reasons other than the products or infringement of third-party intellectual property rights and any other rights due to the use of the information described herein.
3. SII Semiconductor Corporation is not responsible for damages caused by the incorrect information described herein.
4. Take care to use the products described herein within their specified ranges. Pay special attention to the absolute maximum ratings, operation voltage range and electrical characteristics, etc.
SII Semiconductor Corporation is not responsible for damages caused by failures and/or accidents, etc. that occur due to the use of products outside their specified ranges.
5. When using the products described herein, confirm their applications, and the laws and regulations of the region or country where they are used and verify suitability, safety and other factors for the intended use.
6. When exporting the products described herein, comply with the Foreign Exchange and Foreign Trade Act and all other export-related laws, and follow the required procedures.
7. The products described herein must not be used or provided (exported) for the purposes of the development of weapons of mass destruction or military use. SII Semiconductor Corporation is not responsible for any provision (export) to those whose purpose is to develop, manufacture, use or store nuclear, biological or chemical weapons, missiles, or other military use.
8. The products described herein are not designed to be used as part of any device or equipment that may affect the human body, human life, or assets (such as medical equipment, disaster prevention systems, security systems, combustion control systems, infrastructure control systems, vehicle equipment, traffic systems, in-vehicle equipment, aviation equipment, aerospace equipment, and nuclear-related equipment), excluding when specified for in-vehicle use or other uses. Do not use those products without the prior written permission of SII Semiconductor Corporation. Especially, the products described herein cannot be used for life support devices, devices implanted in the human body and devices that directly affect human life, etc.
Prior consultation with our sales office is required when considering the above uses.
SII Semiconductor Corporation is not responsible for damages caused by unauthorized or unspecified use of our products.
9. Semiconductor products may fail or malfunction with some probability.
The user of these products should therefore take responsibility to give thorough consideration to safety design including redundancy, fire spread prevention measures, and malfunction prevention to prevent accidents causing injury or death, fires and social damage, etc. that may ensue from the products' failure or malfunction.
The entire system must be sufficiently evaluated and applied on customer's own responsibility.
10. The products described herein are not designed to be radiation-proof. The necessary radiation measures should be taken in the product design by the customer depending on the intended use.
11. The products described herein do not affect human health under normal use. However, they contain chemical substances and heavy metals and should therefore not be put in the mouth. The fracture surfaces of wafers and chips may be sharp. Take care when handling these with the bare hands to prevent injuries, etc.
12. When disposing of the products described herein, comply with the laws and ordinances of the country or region where they are used.
13. The information described herein contains copyright information and know-how of SII Semiconductor Corporation.
The information described herein does not convey any license under any intellectual property rights or any other rights belonging to SII Semiconductor Corporation or a third party. Reproduction or copying of the information described herein for the purpose of disclosing it to a third-party without the express permission of SII Semiconductor Corporation is strictly prohibited.
14. For more details on the information described herein, contact our sales office.

1.0-2016.01

