



Chipsmall Limited consists of a professional team with an average of over 10 year of expertise in the distribution of electronic components. Based in Hongkong, we have already established firm and mutual-benefit business relationships with customers from,Europe,America and south Asia,supplying obsolete and hard-to-find components to meet their specific needs.

With the principle of “Quality Parts,Customers Priority,Honest Operation,and Considerate Service”,our business mainly focus on the distribution of electronic components. Line cards we deal with include Microchip,ALPS,ROHM,Xilinx,Pulse,ON,Everlight and Freescale. Main products comprise IC,Modules,Potentiometer,IC Socket,Relay,Connector.Our parts cover such applications as commercial,industrial, and automotives areas.

We are looking forward to setting up business relationship with you and hope to provide you with the best service and solution. Let us make a better world for our industry!



Contact us

Tel: +86-755-8981 8866 Fax: +86-755-8427 6832

Email & Skype: info@chipsmall.com Web: www.chipsmall.com

Address: A1208, Overseas Decoration Building, #122 Zhenhua RD., Futian, Shenzhen, China



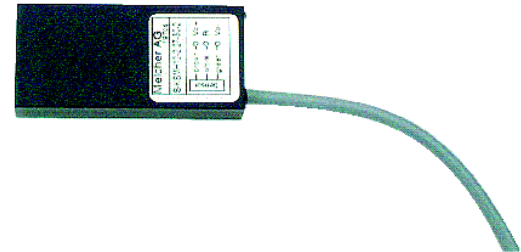

Description

Melcher offers a wide range of battery charger systems consisting of adapted power supplies and appropriate temperature sensors. The (lead-acid) batteries are charged according to the battery temperature and the properties of the battery cells. When the battery is fully charged, it is maintained at the float charge voltage, which represents the optimum point for maximum available energy and optimum life expectancy of the battery. It is essential to place the sensor as close to the battery as possible thus sensing the battery temperature.

The most suited sensor model is defined mainly by three parameters: The nominal battery voltage (e.g. 24 V or 48 V), the temperature coefficient of the cells (e.g. -3.0 mV/K), and the nominal floating charge voltage per cell at 20 °C (e.g. 2.27 V/cell). The latter two are specified in the data sheet of the battery.

The temperature sensors K can be used with all Melcher converters with the standard R-input. This input allows for the control of the output voltage, see fig. 1. The open R input exhibits a source voltage of 2.5 V with a source resistor of 4 k Ω .

The sensor can directly be connected to the R-input and is powered from the battery voltage, as shown in fig. 2. The

sensor supersedes the internal voltage control circuit of the converter and adjusts the output voltage exactly to what is needed for the battery.

Note: Some converters exhibit a current droop characteristic to ease the operation in parallel connection. If the temperature sensor K is connected to the R-input, it cancels the droop characteristic and impedes current sharing. We recommend the use of converters with true current sharing (option T).

Different models of battery sensors are available depending on the battery specifications. Table 1 gives an overview of available sensors.

Note: Other types for different cell voltages, temperature coefficients, and cable lengths are available on request.

For example, if the application uses a 48 V battery consisting of 24 cells of 2.27 V, a temperature coefficient of -3.0 mV/K and 2 m cable length, the sensor type is S-KSMH48-2.27-30-2.

Fig. 3 shows the charge voltage depending on the temperature and the battery type. If the sensor is disconnected, the converter output voltage is regulated to $V_{o\ safe}$. This voltage prevents the battery from being overcharged even at high temperature. Overcharging a battery is dangerous and can cause the battery to explode.

Table of Contents

	Page		Page
Description	1	Mechanical Dimensions	3
Fail Safe Operation and Suitable Converters	2	Temperature Sensors for the T Series	3
Converters with DC Input	3		

Copyright © 2016, Bel Power Solutions Inc. All rights reserved.

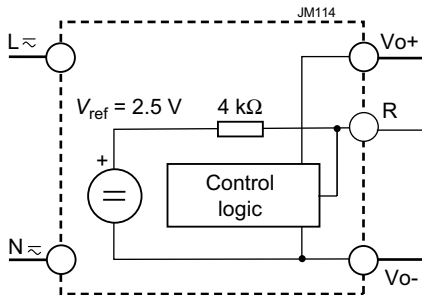

Fig. 1
 Block diagram of Power-One converters suited to be controlled by a battery sensor.

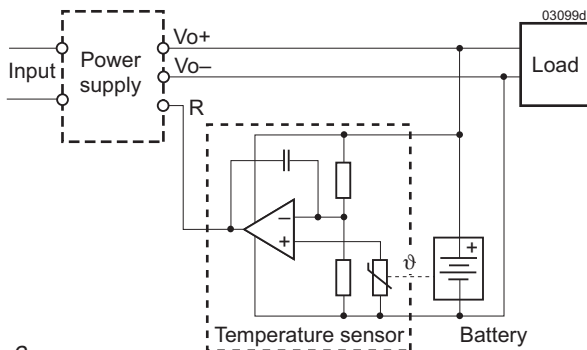

Fig. 2
 Block diagram of the sensor.

Table 1: Sensors for converters with standard R input

Battery voltage nom.[V]	Sensor type	Cell voltage [V]	Cell temp. coefficient [mV/K]	Cable length [m]
12	S-KSMH12-2.27-30-2	2.27	-3.0	2
12	S-KSMH12-2.27-35-2	2.27	-3.5	2
24	S-KSMH24-2.27-30-2	2.27	-3.0	2
24	S-KSMH24-2.27-35-2	2.27	-3.5	2
24	S-KSMH24-2.31-35-0	2.31	-3.5	4.5
24	S-KSMH24-2.31-35-2	2.31	-3.5	2
24	S-KSMH24-2.35-35-2	2.35	-3.5	2
48	S-KSMH48-2.27-30-2	2.27	-3.0	2
48	S-KSMH48-2-27-35-2	2.27	-3.5	2

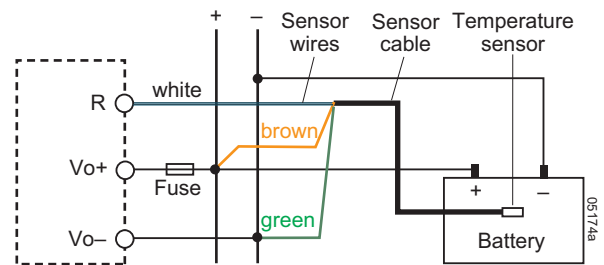

Fig. 4
 Connection of a sensor to the standard R input

Fail Safe Operation and Suitable Converters

To prevent batteries from overcharging but still maintain a minimum charge in case of interruption of the cable from the sensor to the converter, we offer models with special nominal

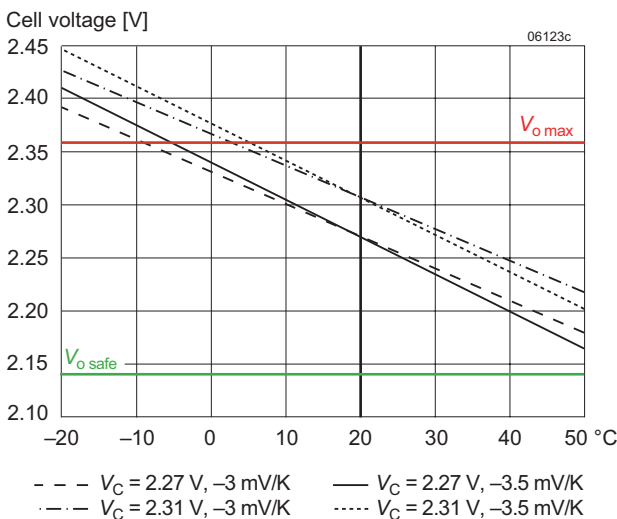

Fig. 3
 Float charge voltage versus temperature for different temperature coefficients.

output voltage setting; see table 2. These converters differ from the respective standard models in the nominal output voltage and output current setting. Without the sensor connected to the R-pin, the output voltage is set to $V_{o \text{ safe}}$. This voltage is higher than the nominal battery voltage such avoiding discharging the battery, but still lower than the theoretically needed float charge voltage. As soon as the sensor is connected to the R-pin, the output voltage will be set to the correct value. This is essential for best energy and battery life time.

The standard converters may also be used for battery charging controlled by the temperature sensor. However, the correct output voltage at low temperature might not be reached. If the sensor is used only for decreasing the output voltage, for instance, if using a 15 V power supply to charge a 12 V battery,

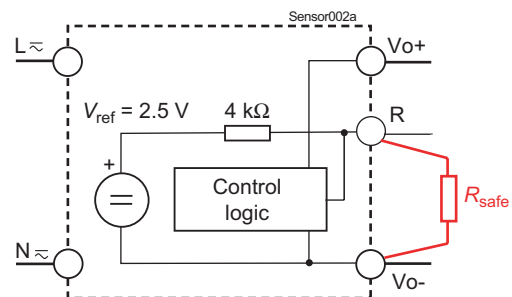

Fig. 5
 Connection of R_{safe} , if standard converter models are used.

Table 2: Special models for battery charging

V_{nom} [V]	V_{safe} [V]	$P_o = 50$ W	$P_o = 70$ W	$P_o = 100$ W $P_o = 125$ W	$P_o = 150$ W	$P_o = 250$ W	$P_o = 280$ W	$P_o = 375$ W $P_o = 500$ W
12	12.84	LM1781-7R LOK4140-2RLD	LH1781-2R	LS4740-9ER ² LWR1140-6EM1	LK4740-9ER CK1740-9R ³	LWN1140-6EM1		
24	25.68	LM1782-7R LOK4240-2RLD	LH1782-2R	LS5740-9ER ² LWR1240-6EM1	LK5740-9ER CK2740-9R ³	LKP5740-9ER LWN1240-6EM1	LKP5741-5ER	LXR1240-6M1 LXN1240-6M1
36	38.52	LM1783-7R	LH1783-2R	LWR1840-6EM1		LWN1840-6EM1		LXR1840-6EM1 LXN1840-6EM1
48	51.36	LM1784-7R LOK4740-2RLD	LH1784-2R	LS5740-9ER ^{1 2} LWR1740-6EM1	LK5740-9ER ¹ CK2740-9R ^{1 3}	LKP5740-9ER ¹ LWN1740-6EM1	LKP5741-5ER ¹	LXR1740-6M1 LXN1740-6M1
60	64.2	LM1785-7R	LH1785-2R					

¹ Both outputs connected in series.

² Similar models with DC input (DS/LS1740, DS/LS2740) are available as well.

³ DC input; DK/LK1740 and DK/LK2740 are available as well.

NFND

Not for new designs

then disconnecting the sensor results in a dangerous situation. We recommend to add a resistor between the R input and its reference, which adjusts the output voltage with disconnected sensor to $V_{o\ safe}$. This is shown in fig. 5.

Converters with DC Input

Most of the models listed in table 2 have an AC input. However, there are applications requiring battery charging from a DC source – sometimes even without electrical isolation.

For this purpose, DC-DC converters of Q, P, M, S, K, or R Series may be used, such as all switching regulators PSx, provided that they exhibit the standard R input.

For safe operation, we recommend to provide a resistor R_{safe} with the correct value (see fig. 5).

Mechanical Dimensions

All dimensions in mm.

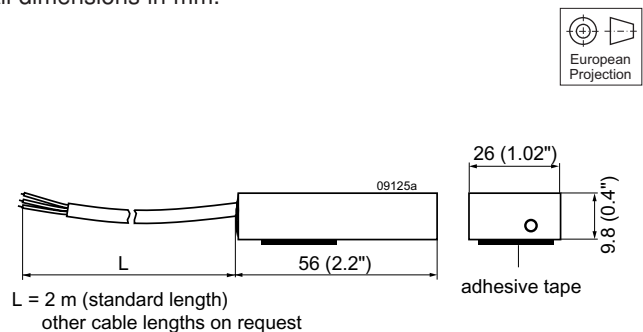

Fig. 6
S-KSMH temperature sensor.

Temperature Sensors for the T Series

T Series battery chargers exhibit a cell voltage selector switch to set the required floating charge voltage directly at the

converter. A special temperature sensor T matches to the T Series. All details are provided in the T Series data sheet at our web site.

NUCLEAR AND MEDICAL APPLICATIONS - These products are not designed or intended for use as critical components in life support systems, equipment used in hazardous environments, or nuclear control systems.

TECHNICAL REVISIONS - The appearance of products, including safety agency certifications pictured on labels, may change depending on the date manufactured. Specifications are subject to change without notice.

Copyright © 2016, Bel Power Solutions Inc. All rights reserved.

www.belpowersolutions.com