



Chipsmall Limited consists of a professional team with an average of over 10 year of expertise in the distribution of electronic components. Based in Hongkong, we have already established firm and mutual-benefit business relationships with customers from,Europe,America and south Asia,supplying obsolete and hard-to-find components to meet their specific needs.

With the principle of “Quality Parts,Customers Priority,Honest Operation,and Considerate Service”,our business mainly focus on the distribution of electronic components. Line cards we deal with include Microchip,ALPS,ROHM,Xilinx,Pulse,ON,Everlight and Freescale. Main products comprise IC,Modules,Potentiometer,IC Socket,Relay,Connector.Our parts cover such applications as commercial,industrial, and automotives areas.

We are looking forward to setting up business relationship with you and hope to provide you with the best service and solution. Let us make a better world for our industry!



## Contact us

Tel: +86-755-8981 8866 Fax: +86-755-8427 6832

Email & Skype: info@chipsmall.com Web: www.chipsmall.com

Address: A1208, Overseas Decoration Building, #122 Zhenhua RD., Futian, Shenzhen, China



# EPD Extension Kit User Manual

<b>Date</b>	<b>2015/ 03/ 05</b>
<b>Revision</b>	<b>03</b>

龍亭新技股份有限公司 Pervasive Displays, Inc.

4F, No. 28, Chuangye Rd., Tainan Science Park,  
Tainan City (74144), Taiwan (R.O.C.)

Tel: + 886-6-279-5399 / Fax: + 886-6-505-5300 /

<http://www.pervasivedisplays.com>

## Index

<b>1. Introduction</b>	<b>3</b>
<b>2. Kit Contents and System Requirements</b>	<b>4</b>
2.1 EPD Extension Kit	4
2.2 Hardware included in the kit	5
2.3 Hardware excluded in the kit	8
2.4 Software	9
2.5 System Requirements	10
<b>3. Getting Started</b>	<b>11</b>
3.1 Program firmware to LaunchPad	11
3.1.1 Using FET-Pro430 to Program MSP430	11
3.1.2 Using TI CCStudio to Program MSP430	14
3.2 Installing EPD Kit Tool	15
3.3 Assembling the EPD Extension Kit with LaunchPad	16
3.4 Getting started with Kit	20
3.5 Working with EPD Kit Tool	22
<b>4. Bridging with Other Development Board</b>	<b>26</b>
4.1 Pin assignment	26
4.2 Connect via Bridging Cable	27
<b>5. Glossary of Acronyms</b>	<b>30</b>

## 1. Introduction

Thank you for purchasing the EPD Extension Kit for low-power electrophoretic paper display (EPD) solutions. This document provides an overview of the Kit and is organized into five main sections: (1) the Kit contents and system requirements, (2) setup and preparation, (3) program firmware, (4) working with the Kit to drive EPD and (5) bridging with other development kit. You will find a glossary of acronyms and references at the end of this document.





The EPD Extension Kit consists EPD extension board and 2" (1.44", 1.9", 2.6" and 2.7") EPD. The EPD extension board supports driving Pervasive Displays Inc. (PDI)'s 1.44, 1.9, 2.0, 2.6 and 2.7 inch EPD modules. It has 20 pins socket at the rear side to stack on Texas Instruments (TI)'s LaunchPad board. It also provides a 20 control pins connection with your product or development kit to drive EPD via SPI interface.



## 2. Kit Contents and System Requirements

### 2.1 EPD Extension Kit

There are five models:

	1.44"	1.9"	2"	2.6"	2.7"
Model Name	<a href="#">S1144CS021</a>	<a href="#">S1190CS021</a>	<a href="#">S1200CS021</a> <a href="#">SG020AS0T2</a>	<a href="#">S1260CS021</a>	<a href="#">S1270CS021</a> <a href="#">SM027AS0T2</a>
Description	1.44" EPD with Extension board	1.9" EPD with Extension board	2" EPD with Extension board	2.6" EPD with Extension board	2.7" EPD with Extension board
Kit content					

## 2.2 Hardware included in the kit

### (1) EPD Extension Board

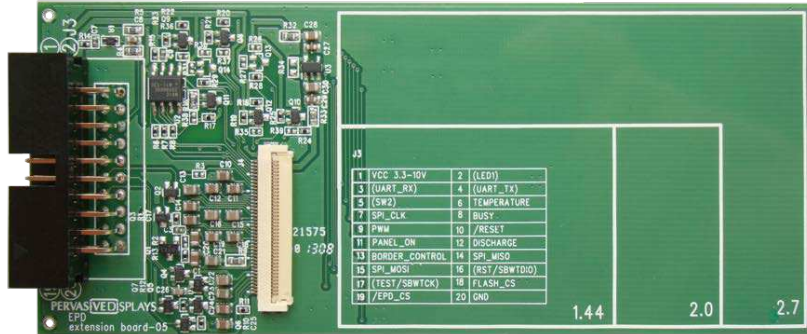

Quantity: 1 piece

The board has embedded EPD driving circuit, 40 pins EPD connector, two 10 pins socket and one 20 pins I/O connector. It also features 8M bits flash memory and temperature sensor on board. The 90 degree 20 pin connector will without box.

### (2) EPD



1.44"



2.0"

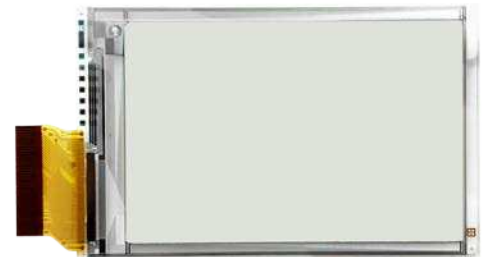

2.7"



1.9"



2.6"

Size	PDI Model Name	Material Film
1.44"	E1144CS021	Aurora Mb(V231)
	EK014BS011	Aurora Ma(V230)
1.9"	E1190CS021	Aurora Mb(V231)
2.0"	E1200CS021	Aurora Mb(V231)
	EG020BS011	Aurora Ma(V230)
2.6"	E1260CS021	Aurora Mb(V231)
2.7"	E1271CS021	Aurora Mb(V231)
	EM027BS013	Aurora Ma(V230)



For how to recognize the material of your display by the rear labels, **please** visit [this webpage](#).

Quantity: 1

The EPD panel is made by PDI connects with extension board displaying content. User does not need to program different size EPD driver codes to attached development kit (ex. LaunchPad). The packets from the demonstration software contain EPD information and display content in the appropriate size format.

### (3) Bridging Cable

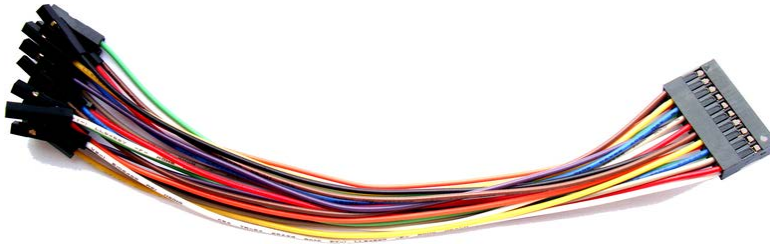

Quantity: 1 piece

It's for measuring EPD signals or bridging to other development kit/product.

### (4) 40 pins Pin Header

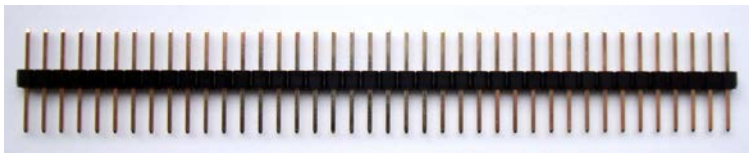

Quantity: 1 piece

If your product or development kit has female type pin header and want to connect with EPD extension board for development, this male-male pin header is provided in kit.



## 2.3 Hardware excluded in the kit

### (1) MSP 430 LaunchPad (MSP-EXP430G2553)

It's Texas Instruments (TI)'s MSP430 LaunchPad development kit. To get started with EPD development by EPD Extension Kit, user can purchase this box from [TI's official website](#) or its distribution channels. The box contains one MSP-EXP430G2 LaunchPad development board, one mini-USB cable and other accessories.

The MSP-EXP430G2 LaunchPad development board features: 14-/20-pin DIP (N) socket, built-in flash emulation for debugging and programming, 2 programmable LEDs, 1 power LED, 1 programmable button and 1 reset button.

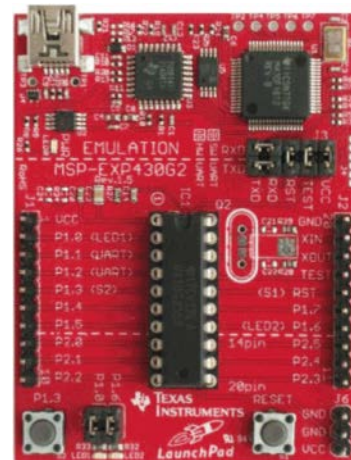

### (2) MSP 430 LaunchPad (MSP-EXP430F5529LP)

It's also TI's MSP430 LaunchPad development kit with more powerful MSP430 MCU F5 series. Visit [this link](#) for more information.

The box contains one MSP-EXP430F5529LP LaunchPad development board, one micro-USB cable and other accessories.

If you are first time with this EPD Extension kit and will order TI LaunchPad to work with, we would highly suggest choosing this MSP-EXP430F5529LP, not the previous MSP-EXP430G2553.



## 2.4 Software

There are two ways to install the demonstration tool. The first one is called “EDP Kit Tool” which is made by PDI and running on Microsoft Windows. This one will be introduced in this document later. The second one is available under [Apache License, Version 2.0](#) hosted by [GitHub](#) at [repaper community](#).

### (1) EDP Kit Tool

This tool is packed as Windows installer. The Installer will install TI LaunchPad interface driver and demo images.

This EPD Kit tool provides a graphical user interface and enables the user to load bitmap images, run slide show and send ASCII code to the EPD for demonstration purposes. The source code of this tool is openly provided on [PDI official website](#).

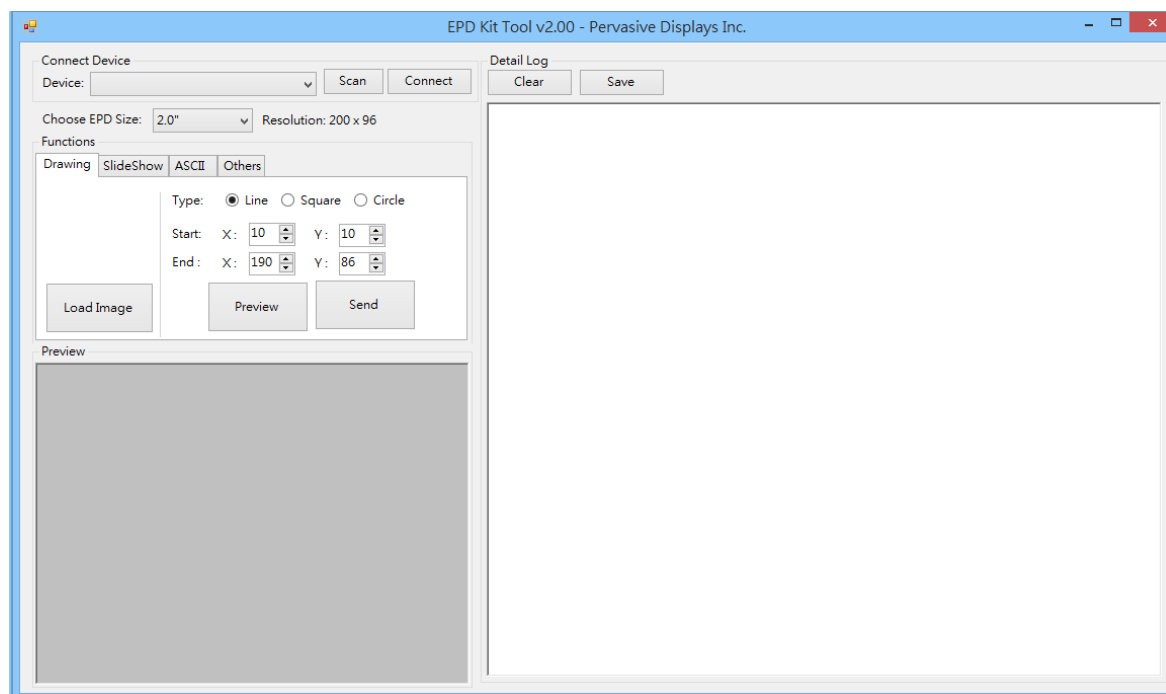

### (2) Repaper software

The project code officially supports both the Arduino-based and Ti LaunchPad Energia platforms.

The files include some conditional code to switch between the two platforms. For more details, please visit [repaper.org](#).

## 2.5 System Requirements

To use the EPD Kit tool, the following hardware and software elements are required:

- (1) A computer running Microsoft® Windows® (XP or above).
- (2) From a hardware standpoint, a Windows® computer with at least one free USB port to connect with the LaunchPad board.

## 3. Getting Started

This section provides instructions to set up the EPD Extension Kit with TI LaunchPads and use the EPD Kit Tool to update content on EPD display.

There are five steps to prepare the Kit:

1. **Program firmware to LaunchPad**
2. **Installing the EPD Kit Tool**
3. **Assembling the EPD Extension Kit with LaunchPad**
4. **Getting started with Kit**
5. **Working with EPD Kit Tool**

### 3.1 Program firmware to LaunchPad

There are two approaches to update firmware to the MSP430 of LaunchPad.

- (1) Using FET-Pro430 to Program MSP430
- (2) Using TI CCStudio to Program MSP430



Please download “EPD Extension Board v2.00 for MSP430 LaunchPad” from PDI’s [EPD Extension Kit webpage](#). Please extract the “.rar” file. It’s developed by TI CCStudio v6.0x project code. In the “MSP430F5529” or “MSP430G2553” folder, you are able to find an “EPD\_Extension\_Board.out” file. We will need the firmware to program the MSP430 MCU later if you will use FET-Pro430 utility.

#### 3.1.1 Using FET-Pro430 to Program MSP430

FET-Pro430 programming software is a software package designed to operate with existing programming adapters provided by Texas Instruments and other vendors. The FET-Pro430 Lite can program Texas Instruments MSP430/CC430 family of microcontrollers via JTAG or USB interface.



If you don’t have TI’s CCStudio installed, you can use this FET-Pro430 to update firmware, or you can skip this section and direct to section 3.1.2 to use CCStudio to program firmware.

- Software Installation
  - (1) Download the FET-Pro430 Lite software from [Elprotronic. Elprotronic Inc.'s website](#). It's free and about 16MB file size.
  - (2) Double click on FET-Pro430 Lite installer. The setup wizard appears automatically. Click to begin the installation process.
  - (3) Once the installation program starts, on-screen instructions will guide you through the remainder of the installation. You must accept license agreement before using software.
- Startup FET-Pro430 Lite and program firmware
  - (1) Use an USB to mini-USB (or micro-USB) cable that provided in the TI LaunchPad box to connect between computer's USB Port and LaunchPad's USB port.

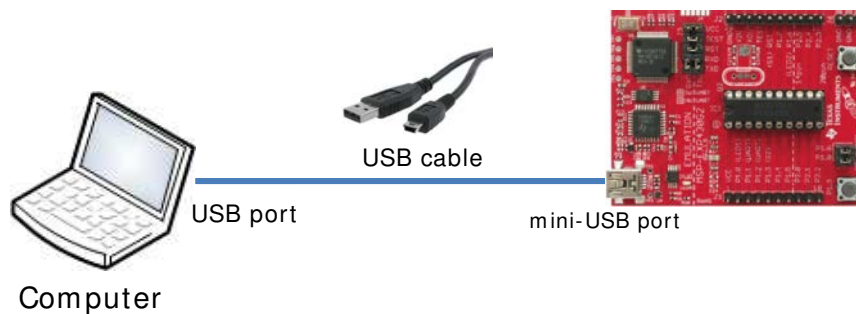

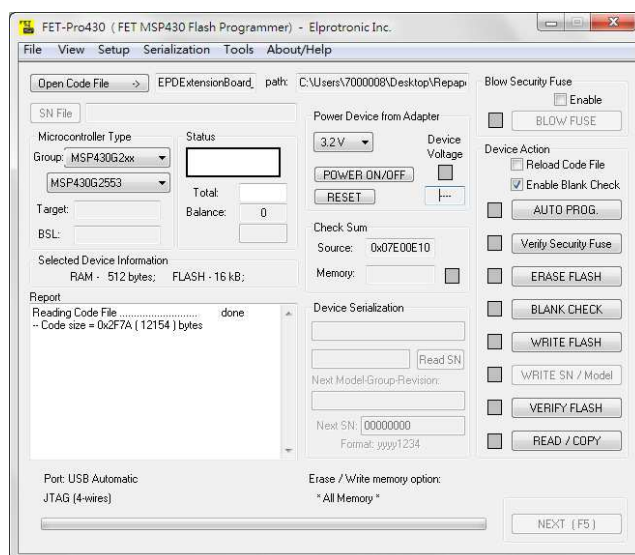

- (2) If you have installed the EPD Kit Tool (Section 3.2), the “MSP430 Application UART” driver had installed in your computer and can be found under Ports (COM & LPT) in your Device Manager.
- (3) To start the FET-Pro430 Lite, click on the Lite/FET-Pro430 Elprotronic icon. The programming dialogue box shows as below:





- (4) Select the group of Microcontroller Type to
- If connecting with MSP-EXP430G2553 LaunchPad, choose “MSP430G2xx” and the second dropdown list to “MSP430G2553”.
  - If connecting with MSP-EXP430F5529LP LaunchPad, choose “MSP430F5xx” and the second dropdown list to “MSP430F5529”.



- (5) Click  to select the firmware “.out” or “.hex” file to program the LaunchPad. In the Open dialogue, select “TI’s CCE (\*.out)” at Files of type and point the file path to select the out file (“EPD\_Extension\_Board.out”) you will program onto MSP430 MCU.
- (6) Make sure you have connected well the USB with LaunchPad board. Click  to start programming firmware.

- (7) Please make sure you get the status  “Pass” which means the programming process is run successfully.



The .out file programming to LaunchPad is for Aurora Mb(V231) type EPD. If your connected EPD is Aurora Ma(V230), you will need TI CCStudio IDE development tool to load our source project code and change parameter in code to work with Aurora Ma(V230) type displays.

## 3.1.2 Using TI CCStudio to Program MSP430

- (1) Please get ready the Texas Instruments Code Composer Studio (CCStudio) project code for LaunchPad kit. The default Workspace name is “EPD Extension Board”. We suggest upgrading your CCStudio to version 6.0 above which is also our compiled environment with MSP430 compiler v4.3.5.
- (2) Start your CCStudio. You will be asked to select a workshop. Please point to the CCStudio workspace folder of this kit and click [OK].

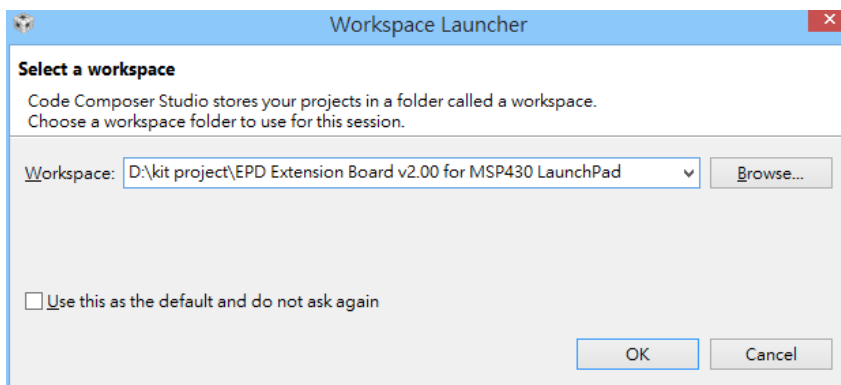

- (3) After entering the CCStudio IDE tool, the Project Explorer shows the code structure likes below.

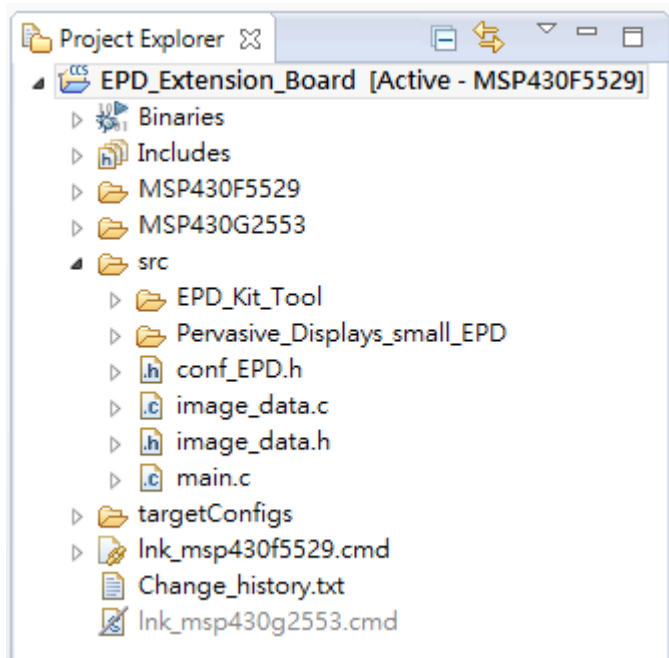

- (4) Find “#define Gx\_Aurora\_Mx” in "conf\_EPD.h" file under [src] folder. Change to the correct type of EPD you are connecting. The options are G2\_Aurora\_Ma and G2\_Aurora\_Mb. Please visit [this link](#) to check with the type of your display.
- (5) To compile the code and download the firmware to the LaunchPad, right click on

the project root folder from Project Explorer, on the pop-up menu to select [Build Configurations] / [Set Active] / Select the correct LaunchPad that you are connected.

- (6) After ensuring the correct LaunchPad model has shown on project name, select from menu [Project] / [Build All (F9)] and wait for building complete and make sure there is no errors in the “Problems” window.
- (7) Click on the [Debug] button of tool bar or right click on the project to select [Debug As] / [1 Code Composer Debug Session].

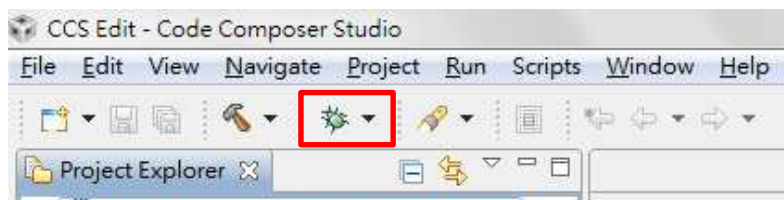

- (8) A progress information window will pop up and start to download firmware code to the MSP430 MCU of LaunchPad board. Once the download process is done successfully, this window will be closed. The LaunchPad board is now built and tested of the firmware code. You can start debugging the code.

Click the  Terminate button go back to CCStudio Edit.

## 3.2 Installing EPD Kit Tool

- (1) Download the installer of EPD Kit Tool from PDI [Extension kit](#) page. The installer name is “EPD Kit Tool v#.## Installer” where # is number for tool version.
- (2) Double click the installer to start the installation.
- (3) Follow the instructions on the screen to install the program. The installer will also install the driver (MSP430 Application UART) for the LaunchPad to your computer.
- (4) If you connect the LaunchPad with computer via USB port now, the Windows® operation system will start to search the driver. You will find the “MSP430 Application UART” or “MSP Application UART” device is installed under Ports (COM & LPT) in your Device Manager.



## 3.3 Assembling the EPD Extension Kit with LaunchPad

(1) Connect the EPD to the EPD extension board

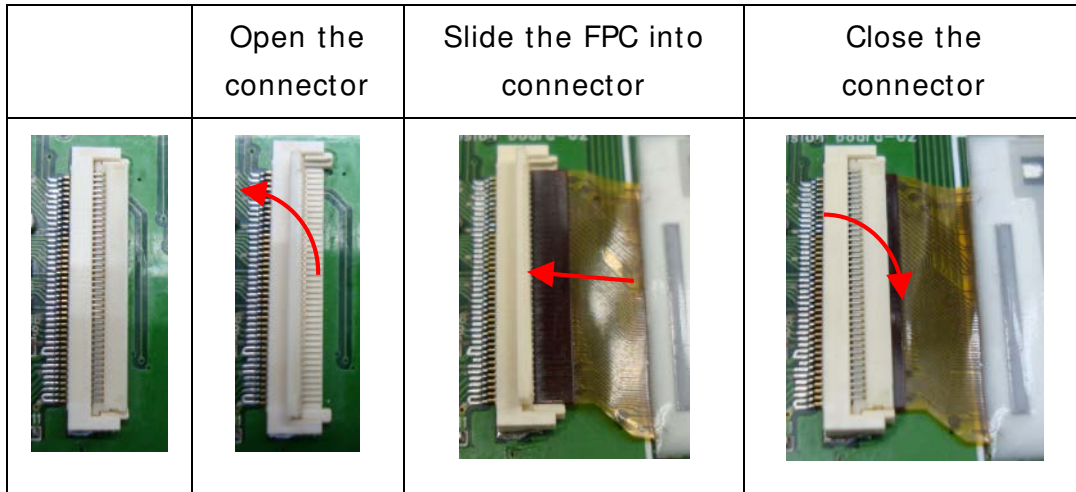

The picture below is connected with a 2" EPD on EPD extension board.

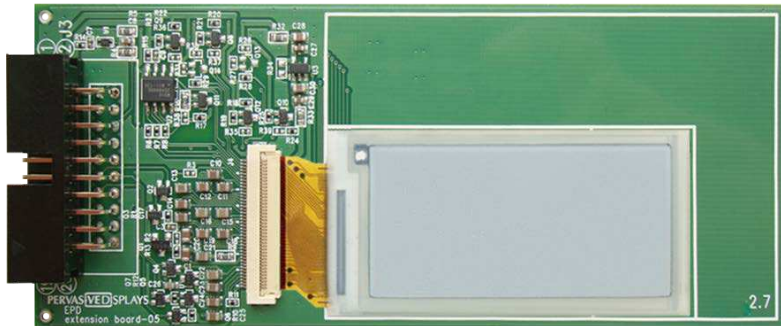

### ➤ For MSP-EXP430G2553 LaunchPad:

(2) Make sure the MSP430G2553 IC on LaunchPad

Both PDIP14 (14 pins) and PDIP20 (20 pins) devices of the MSP430G2xx Value Line and the MSP430F20xx family can be inserted into the DIP IC socket of LaunchPad. Please make sure you connect the LaunchPad with an inserted MSP430G2553 MCU (M430G2553) to the IC1 socket. The code default supports MSP430G2553 MCU.



(3) Adjust the J3 and J5 jumpers of LaunchPad

The EPD extension board uses hardware UART, so the RXD and TXD of J3 jumper must change the orientation. The EPD extension board also uses the same pin of LED2. The P1.6 of J5 needs to be opened.

(a) J3 jumper

The RXD and TXD are changed to horizontal orientation.

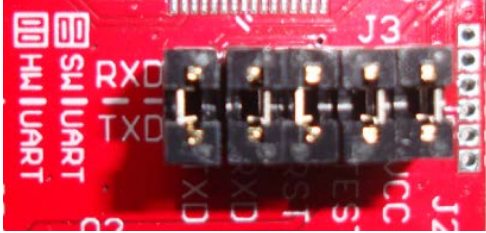
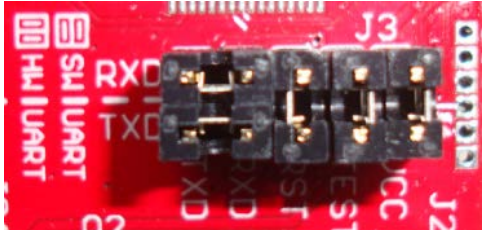
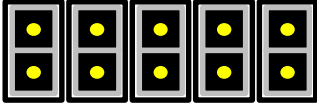
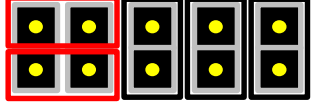
Default	Change to
	
	



The jumper setting above is for MSP430 LaunchPad rev. 1.5. You can find the version number on Launchpad board. Please check it is “MSP-EXP430G2 Rev.1.5”. If your LaunchPad board is older than this version, please find the schematic of your LaunchPad board and jumped [TXD]-[P1.1] and [RXD]-[P1.2].

(b) J5 jumper

Open the P1.6 of J5.

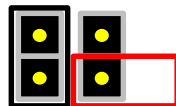
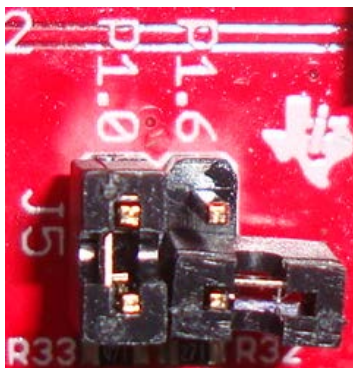

(4) Stack the EPD extension board on LaunchPad

There are two 10 pins socket at the rear of EPD extension board allows user to stack on MSP-EXP430G2 LaunchPad board. Please make sure the assembly direction of EPD extension board to align with LaunchPad headers.



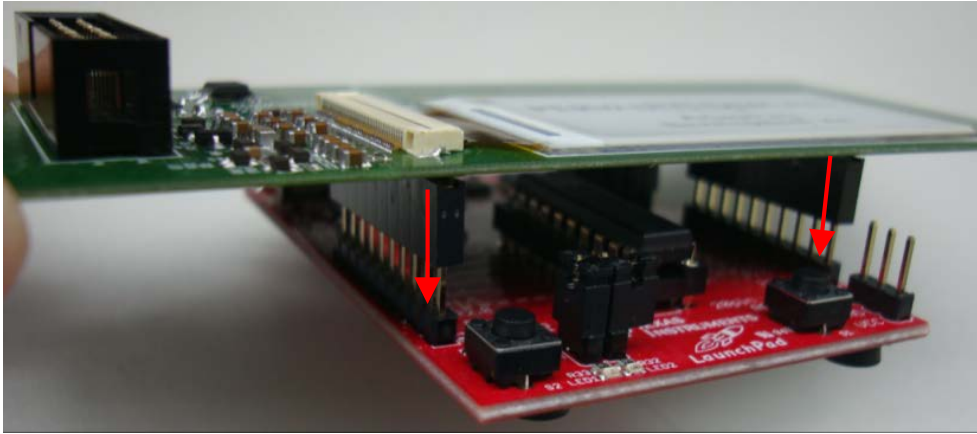

The final installation diagram is as follows.

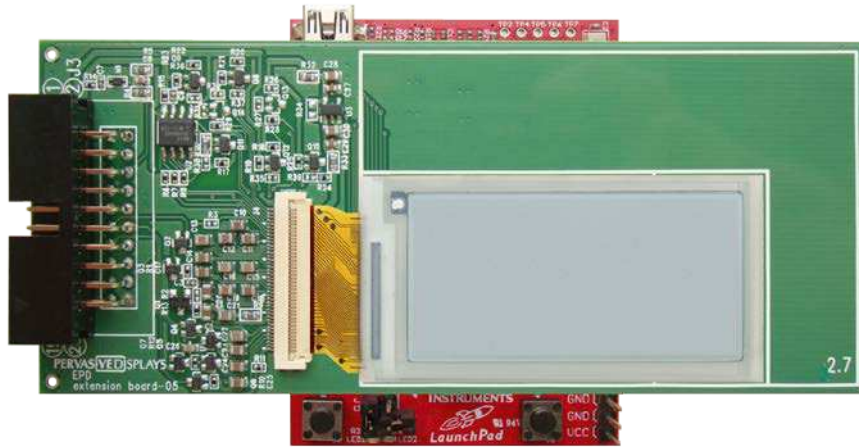

➤ **For MSP-EXP430F5529LP LaunchPad:**

(2) Adjust the jumpers of LaunchPad

You don't need to adjust the main jumper on MSP-EXP430F5529LP board. Make sure your jumper is like the picture below.

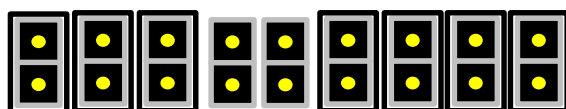
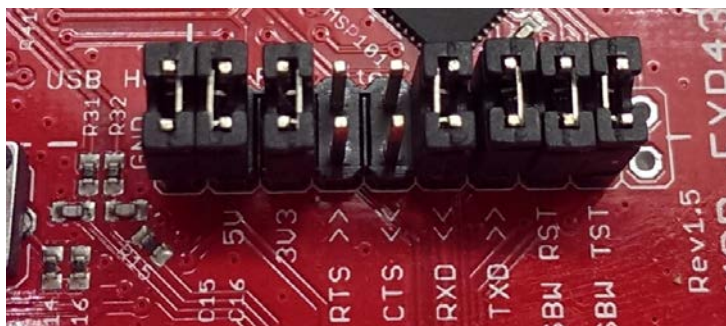

(3) Open JP8 jumper



(4) Stack the EPD extension board on LaunchPad

There are two 10 pins socket at the rear of EPD extension board allows user to stack on MSP-EXP430F5529LP LaunchPad board. Please make sure the assembly direction of EPD extension board to align with the **outer** LaunchPad headers.

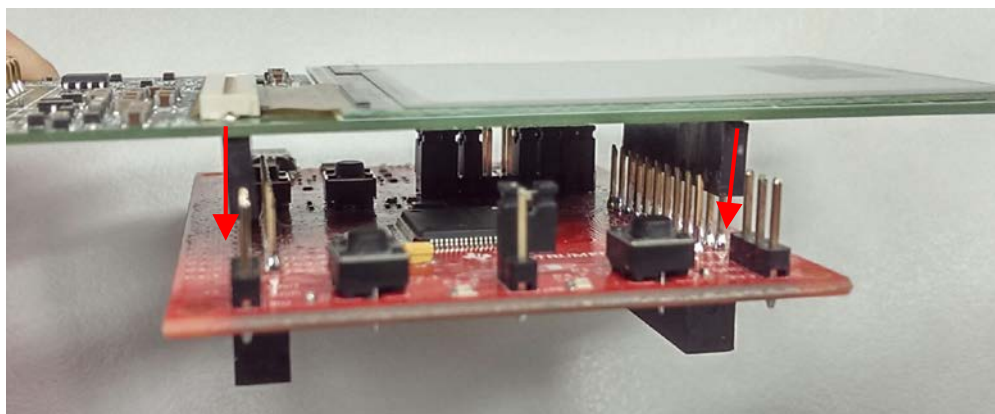

## 3.4 Getting started with Kit

This section will introduce the EPD Kit Tool and how to update content by this tool.

After installing the EPD Kit Tool, the default program directory is located at “C:\Program Files\Pervasive Displays\EPD Kit Tool”. There is some demonstration images at “EPD Kit Tool\images” folder of User’s Documents.

### (1) Overview of EPD Kit Tool

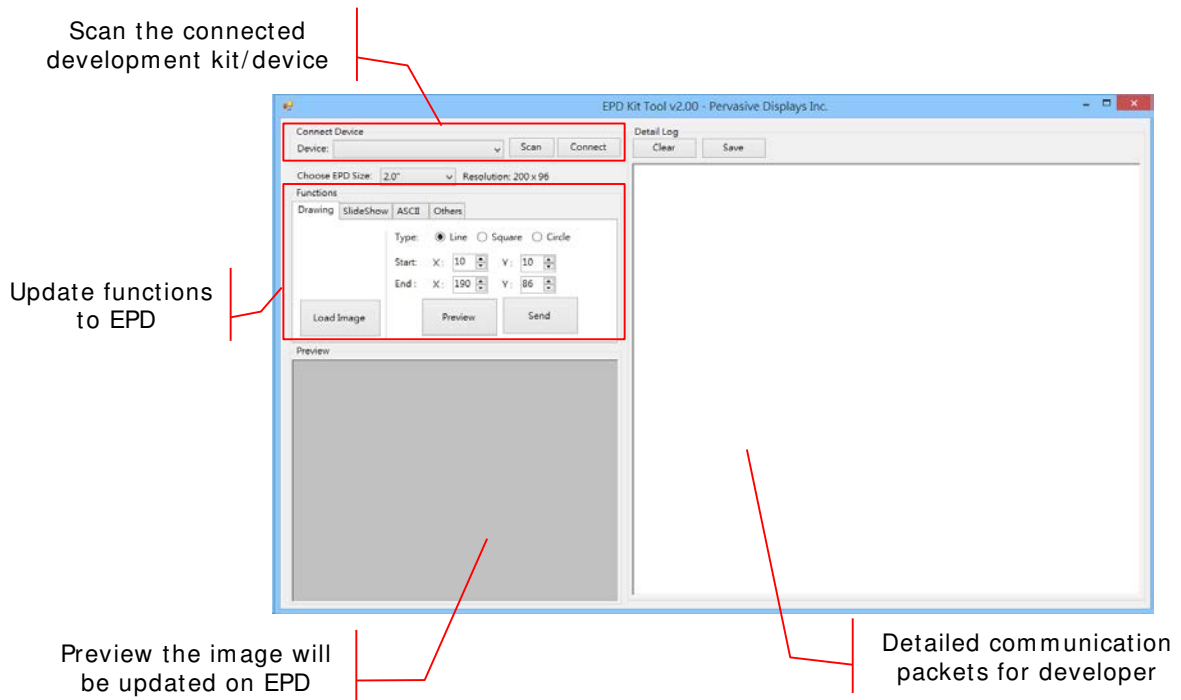

### (2) Connect the kit to your computer

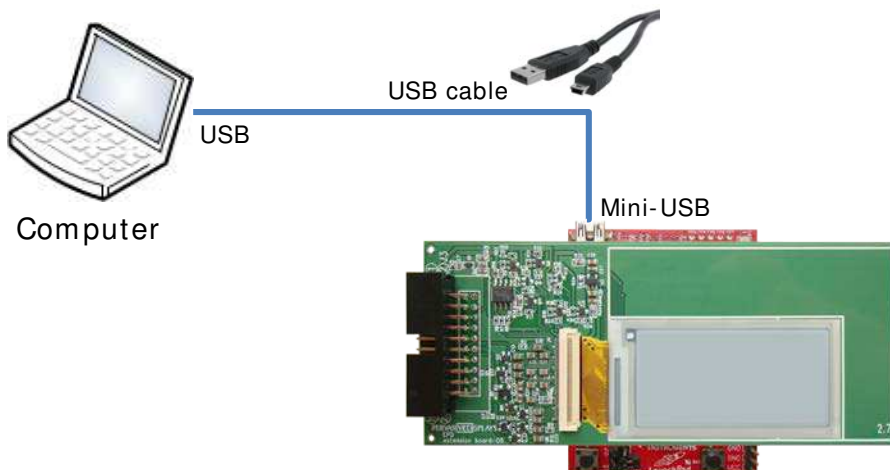

Please use the USB cable with the LaunchPad box to connect with the USB port of

your computer and the mini-USB/micro-USB port of LaunchPad.

(3) Detect the development board

Click the [Scan] button to detect the supported connecting development board.

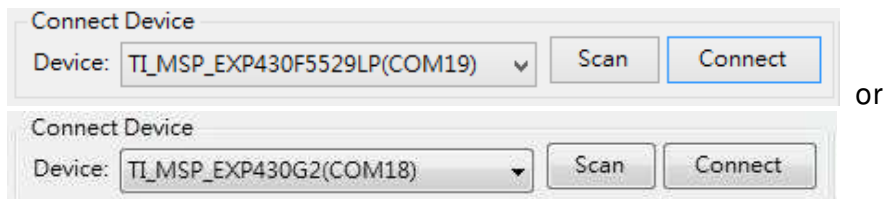

If the TI LaunchPad connects correctly, you will find the Device shows “TI\_MSP\_EXP430F5529LP(COMxx)” or “TI\_MSP\_EXP430G2(COMxx)” in the dropdown list. The COM port number should be different from this example.

Remember to click [Connect] button to get connection with the LaunchPad. The [Connect] button will be changed to [Disconnect]. You can click on it to disconnect with LaunchPad if you don't want to work with it later.



After connecting with the LaunchPad, the Detail Log box will show some information like firmware version and ambient temperature. It means you can start working with this kit set and tool now.

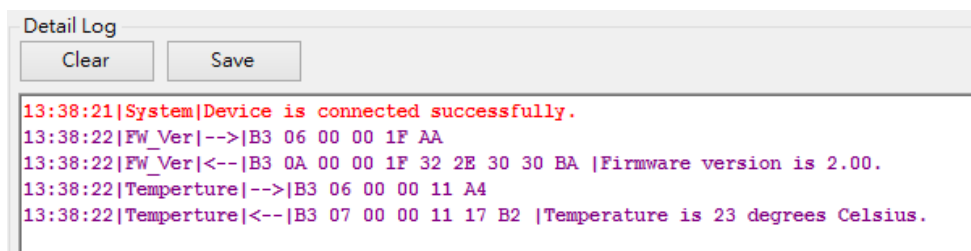

(4) Select the correct EPD size

Please choose the EPD size that you just connected with the EPD extension board. The size selected must match the EPD size.



The dropdown list has 1.44”, 1.9”, 2”, 2.6” and 2.7” items and will show the corresponding resolution.

## 3.5 Working with EPD Kit Tool

There are four group functions to update content on EPD with the EPD kit tool.

- **Drawing:**  
to load image immediately; draw line, square, circle by provided coordinate
- **Slideshow:**  
to preload images and set the slideshow effect on or off
- **ASCII:**  
type ASCII code and show the code on EPD without whole image update
- **Others:**  
to load image by defined index; show temperature, firmware version and some control commands

### (1) Drawing

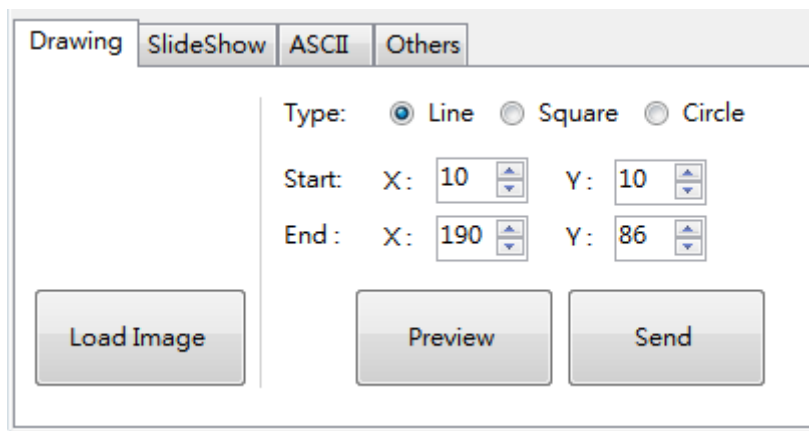

- You can click the [Load Image] button to select an image to show on EPD right away. Select the same size image matches the EPD size you just selected by last step. The default pop-up window will point you to the “Images” directory of User Document generated by installer. The resolution information:

EPD size	Image resolution
1.44”	128 * 96
1.9”	144 * 128
2”	200 * 96
2.6”	232 * 128
2.7”	264 * 196

The preview window will show your selected image and convert it to 1 bit bitmap

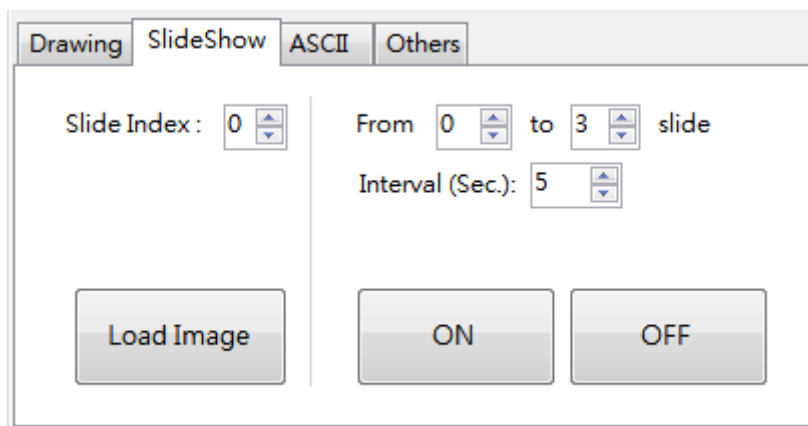

image format. This image will be sent to EPD immediately.

- You can also select one of the three types “Line”, “Square” and “Circle”, and give the start and end coordinate to draw image. The X and Y limit the number to the maximum resolution of EPD size.

Click [Preview] button to confirm the drawing result. Click [Send] button to send this drawing to EPD.

## (2) Slideshow



The left side area is used for uploading image to flash memory by assigned index. After uploading images, the right side area is used for defining how to play the slideshow effect.

- Give the index number starts from 0 to 3. This tool allows preloading 4 images to flash memory. Type 0 and click [Load Image] to select an image. The image selected must match the panel size. The same steps to give number and click [Load Image], until 3 if you want to show 4 images continuously. Every time you select an image, the image will be displayed on the EPD.
- Set the range of numbers you want to apply the slideshow. For example, from 0 to 3<sup>rd</sup> slide. Give an interval time by seconds between each image.
- Click [ON] to enable the slideshow effect right away. You can check whether the EPD is to display different image according to the defined time interval. Now, this slideshow function is able to play automatically without the EPD Kit Tool running. You can connect an USB power adaptor with LaunchPad board via USB port.
- Click [OFF] to disable the slideshow function after connecting the kit and running with the EPD Kit Tool.

## (3) ASCII

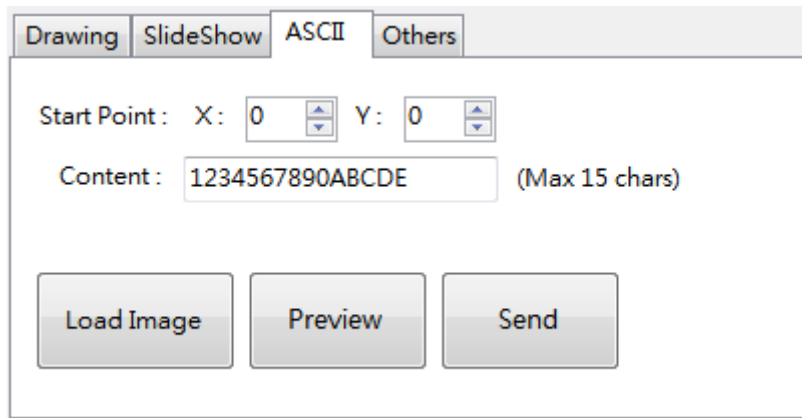

Different from sending image to EPD that we just practiced, the ASCII function is to send ASCII code to EPD directly, not sending an image. The ASCII font has built-in kit, so the communication packets could be very short.

- Click [Load Image] to select an image.
- Give a coordinate X and Y to have the following content (ASCII code) shows on EPD. For example, when X=30 and Y=0 (pixels) and type “1234567890ABCDE” characters, and then click [Preview]. You will find the string you just typed overwriting on the image at (30, 0) position. Click [Send] button to see the output immediately.
- The preview area is just for reference, not the actual output effect. It is just a simulation result. The actual output on EPD is without text background transparent effect for the ASCII codes.
- If you want to remove some characters, try to use space. For example: the first ASCII codes outputs to EPD screen is “Hello World!”. If you want to show “Hello!” and would like to clear the rest of characters after the exclamation mark, you can type “Hello! ” follows 6 spaces after the exclamation mark in the content text box and try to send it on EPD for reviewing.



- (a) This ASCII function presents partial update on EPD, not global update (full screen update). It is a demonstration only to show how to work with ASCII graphic library in code.
- (b) If you are connecting AuroraMa(V230) type display, this ASCII will do nothing on display due to V230 display doesn't support Partial Update in this EPD Kit Tool.
- (c) For more information or how to implement Partial Update, please visit PDi website for more details.

## (4) Others

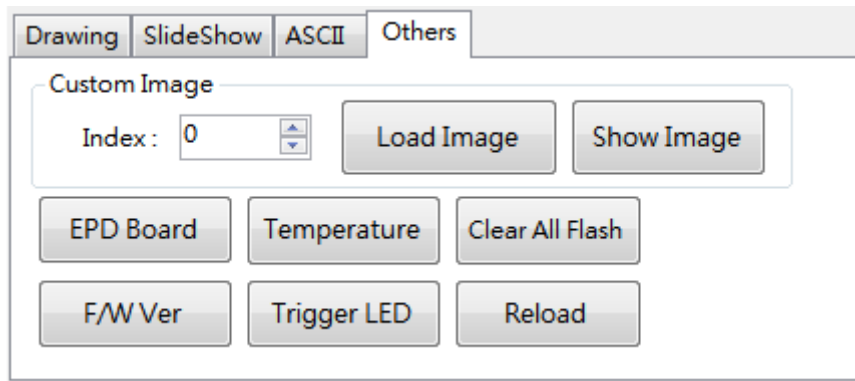

The other commands and functions are located here for user to get information from EPD extension board.

- Custom Image:** It's different from the load image at "Drawing" tab. The load image function at "Drawing" tab updates the image based on a continuous loop memory space to store image data. The Custom Image function here is to store image data by user assigned memory location. You can give the index number (0 to 7) and load image to EPD. The image data will store in assigned memory location. After uploading images, you can type the index number you want and click [Show Image] to show the image directly.
- EPD Board:** to detect whether the EPD extension board stacks on LaunchPad.
 

```
10:13:32|EPD_Board|-->|B3 06 00 00 12 A7
10:13:32|EPD_Board|<--|B3 07 00 00 12 00 A6 | No Extension Board is connected.
10:13:48|EPD_Board|-->|B3 06 00 00 12 A7
10:13:48|EPD_Board|<--|B3 07 00 00 12 01 A7 | Extension Board is connected.
```
- Reload:** to reload the current image that had shown on EPD.
- F/W Ver:** to get the firmware version that had programmed in supported development kit.
 

```
10:10:58|FW_Ver|-->|B3 06 00 00 1F AA
10:10:58|FW_Ver|<--|B3 0A 00 00 1F 30 2E 39 32 B3 |Firmware version is 0.92.
```
- Trigger LED:** to turn on/off the LED1 on LaunchPad.
- Clear All Flash:** to clear all of the data in flash memory.
 

```
09:26:13|Clean_All_Flash|-->|B3 06 00 00 61 D4
09:26:13|Clean_All_Flash|<--|B3 07 00 00 61 01 D4 |Cleared all flash memory.
```
- Temperature:** to get the ambient temperature information.
 

```
10:10:59|Temperture|<--|B3 07 00 00 11 1C B9 |Temperature is 28 degrees Celsius.
10:11:06|EPD_Board|-->|B3 06 00 00 12 A7
```