



Chipsmall Limited consists of a professional team with an average of over 10 year of expertise in the distribution of electronic components. Based in Hongkong, we have already established firm and mutual-benefit business relationships with customers from,Europe,America and south Asia,supplying obsolete and hard-to-find components to meet their specific needs.

With the principle of “Quality Parts,Customers Priority,Honest Operation,and Considerate Service”,our business mainly focus on the distribution of electronic components. Line cards we deal with include Microchip,ALPS,ROHM,Xilinx,Pulse,ON,Everlight and Freescale. Main products comprise IC,Modules,Potentiometer,IC Socket,Relay,Connector.Our parts cover such applications as commercial,industrial, and automotives areas.

We are looking forward to setting up business relationship with you and hope to provide you with the best service and solution. Let us make a better world for our industry!



Contact us

Tel: +86-755-8981 8866 Fax: +86-755-8427 6832

Email & Skype: info@chipsmall.com Web: www.chipsmall.com

Address: A1208, Overseas Decoration Building, #122 Zhenhua RD., Futian, Shenzhen, China



Customer Information Sheet

DRAWING No.: S1731-XXR

SHEET 2 OF 2

IF IN DOUBT - ASK

©

NOT TO SCALE

THIRD ANGLE PROJECTION

ALL DIMENSIONS IN mm

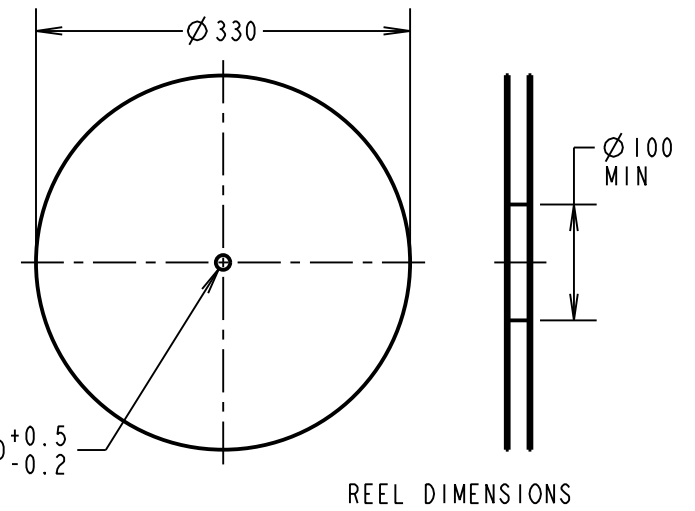
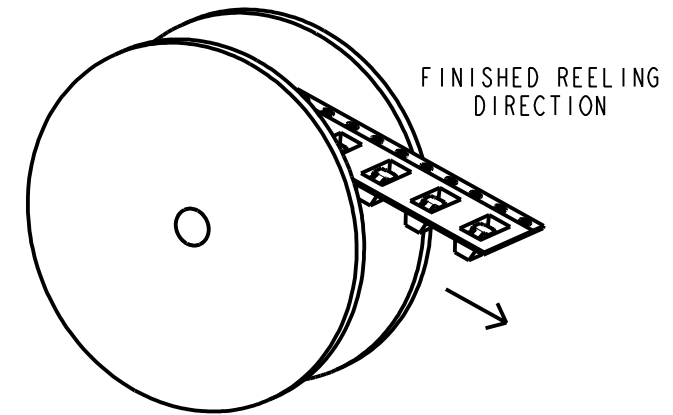
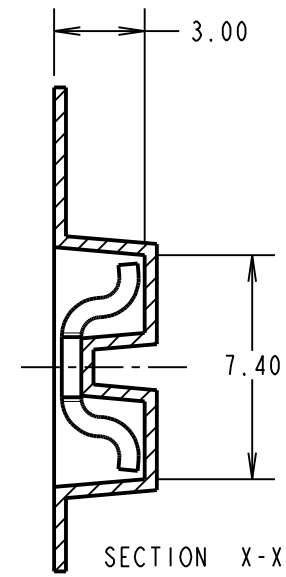
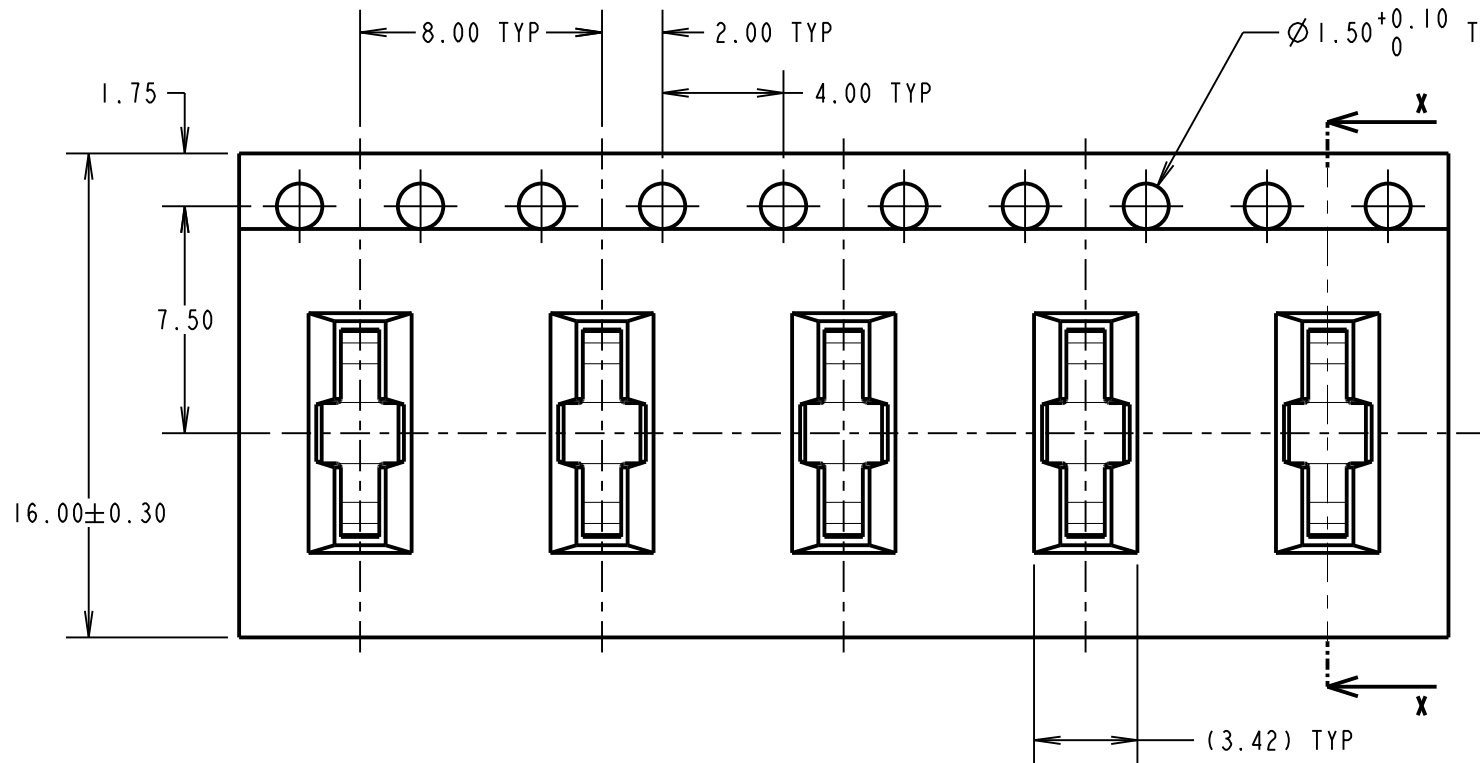

NOTES:

1. QUANTITY PER REEL = 2,500.
2. THIS PRODUCT IS TAPED AND REELED IN ACCORDANCE WITH EIA-481 (ELECTRONIC INDUSTRIES ASSOCIATION).
3. FOR LOOSE PART, SEE DRAWING S1731-XX.

SINGLE COMPONENT DIMENSIONS

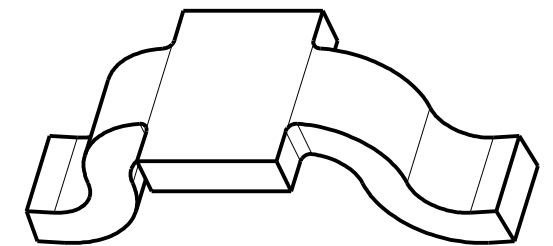
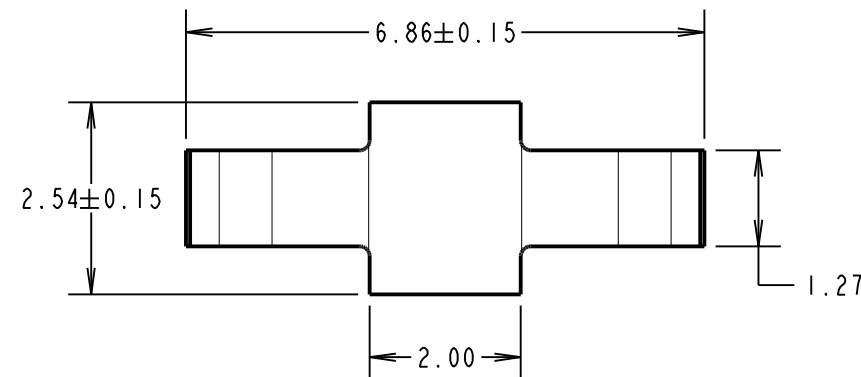

COMPONENT SPECIFICATION:
 MATERIAL = CW004A ETP COPPER
 FINISH:
 06 = 3µ 90/10 TIN/LEAD
 46 = 3µ 100% TIN OVER NICKEL
 ELECTRICAL:
 CURRENT RATING = 10A (30°C TEMP RISE)
 CONTACT RESISTANCE = 20mΩ MAX
 ENVIRONMENTAL:
 OPERAING TEMPERATURE = -40°C TO +125°C

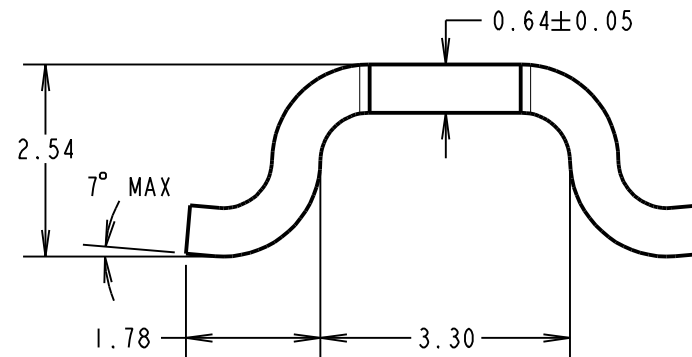

ORDER CODE:
S1731-XX

FINISH:
 06 - 3µ 90/10 TIN LEAD OVER NICKEL
 46 - 3µ 100% TIN OVER NICKEL

MSP	6	16.10.15	13113
NAME	ISS.	DATE	C/NOTE
APPROVED:		M. PERREN	
CHECKED:		S. BENNETT	
DRAWN:		M. G. PLESTED	
CUSTOMER REF.:			
ASSEMBLY DRG.:			

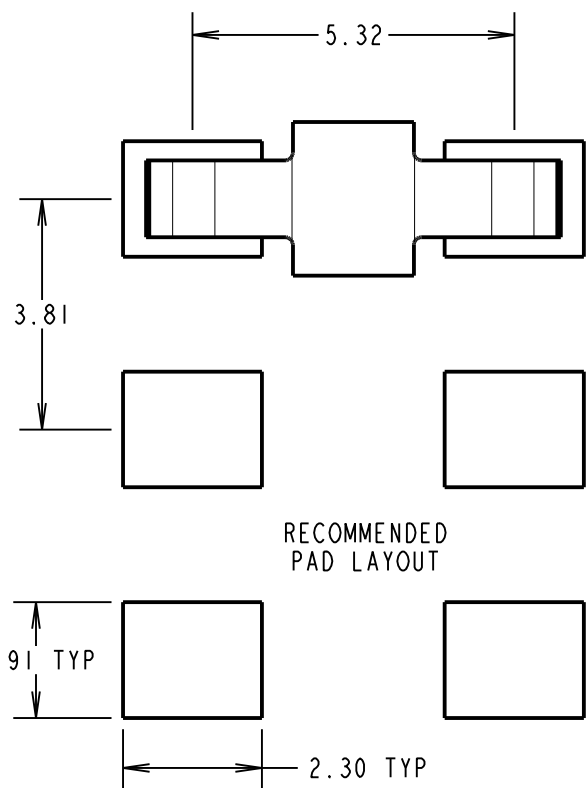

HARWIN

www.harwin.com
technical@harwin.com

THIS DRAWING AND ANY INFORMATION OR DESCRIPTIVE MATTER SET OUT HEREON ARE CONFIDENTIAL AND COPYRIGHT PROPERTY OF THE HARWIN GROUP AND MUST NOT BE DISCLOSED, LOANED, COPIED OR USED FOR MANUFACTURING, TENDERING OR FOR ANY OTHER PURPOSE WITHOUT THEIR WRITTEN PERMISSION.

TOLERANCES
 X. = ±1mm
 X.X = ±0.50mm
 X.XX = ±0.10mm
 X.XXX = ±0.01mm
 ANGLES = ±5°
 UNLESS STATED

MATERIAL:
 SEE ABOVE
FINISH: SEE ABOVE
S/AREA: mm²

TITLE:
 POWER SMT JUMPER LINK
 (TAPE AND REELED)

DRAWING NUMBER:
S1731-XXR

SHT
2 OF 2