



Chipsmall Limited consists of a professional team with an average of over 10 year of expertise in the distribution of electronic components. Based in Hongkong, we have already established firm and mutual-benefit business relationships with customers from,Europe,America and south Asia,supplying obsolete and hard-to-find components to meet their specific needs.

With the principle of “Quality Parts,Customers Priority,Honest Operation,and Considerate Service”,our business mainly focus on the distribution of electronic components. Line cards we deal with include Microchip,ALPS,ROHM,Xilinx,Pulse,ON,Everlight and Freescale. Main products comprise IC,Modules,Potentiometer,IC Socket,Relay,Connector.Our parts cover such applications as commercial,industrial, and automotives areas.

We are looking forward to setting up business relationship with you and hope to provide you with the best service and solution. Let us make a better world for our industry!



Contact us

Tel: +86-755-8981 8866 Fax: +86-755-8427 6832

Email & Skype: info@chipsmall.com Web: www.chipsmall.com

Address: A1208, Overseas Decoration Building, #122 Zhenhua RD., Futian, Shenzhen, China





S30A-6011BA

S3000 Standard

SAFETY LASER SCANNERS

SICK
Sensor Intelligence.



Ordering information

Type	Part no.
S30A-6011BA	1023546

The system plug has to be ordered separately. For details, see "Accessories".

Other models and accessories → www.sick.com/S3000_Standard

system plug not supplied with delivery

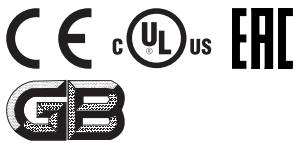

Detailed technical data

Features

Protective field range	5.5 m
Warning field range	49 m (20 m at 20 % reflectivity)
Distance measuring range	49 m
Number of simultaneously monitored protective fields	≤ 4 ¹⁾
Type of field set	Triple field sets, dual field sets
Number of field sets	1
Number of fields	4 ²⁾
Number of monitoring cases	1
Scanning angle	190°
Resolution (can be configured)	30 mm, 40 mm, 50 mm, 70 mm, 150 mm
Angular resolution	0.5°, 0.25°, depending on range and resolution
Response time	60 ms ³⁾
Protective field supplement	100 mm
Number of multiple samplings	2 ... 16, configurable
Delay of automatic reset	2 s ... 60 s, configurable

¹⁾ If more than one protective field is monitored simultaneously, then the safe output signals must be routed to safe outputs of a Flexi Soft safety controller, or via a safe EFI gateway.

²⁾ Two simultaneous field sets with two fields each, output to Flexi Soft via EFI.

³⁾ Depending on basic response time and multiple sampling.

Safety-related parameters

Type	Type 3 (IEC 61496)
Safety integrity level	SIL2 (IEC 61508) SILCL2 (EN 62061)
Category	Category 3 (EN ISO 13849)

Performance level	PL d (EN ISO 13849)
PFH_D (mean probability of a dangerous failure per hour)	8.0 x 10 ⁻⁸ (EN ISO 13849)
T_M (mission time)	20 years (EN ISO 13849)
Safe state in the event of a fault	At least one OSSD is in the OFF state.

Functions

Restart interlock	✓
External device monitoring (EDM)	✓
Multiple sampling	✓
Simultaneous monitoring	✓
Contour as a reference	✓
Integrated configuration memory	✓
Measured data output	✓
Safe SICK device communication via EFI	✓

Electrical data

Protection class	II (EN 50178)
Supply voltage V_s	24 V DC (16.8 V DC ... 28.8 V DC)
Power consumption	≤ 0.8 A ¹⁾ ≤ 2.3 A ²⁾
Outputs	
Output signal switching devices (OSSDs)	2 x 500 mA
Diagnostic outputs	3 x 100 mA ³⁾

¹⁾ At 24 V DC without output load.

²⁾ At 24 V DC including maximum output load.

³⁾ Freely programmable, e.g. warning field, contamination, reset required.

Mechanical data

Dimensions (W x H x D)	155 mm x 185 mm x 160 mm
Weight	3.3 kg
Housing material	Aluminum die cast
Housing color	RAL 1021 (yellow)
Front screen material	Polycarbonate
Front screen surface finish	Outside with scratch-resistant coating

Ambient data

Enclosure rating	IP65 (EN 60529)
Ambient operating temperature	-10 °C ... +50 °C
Storage temperature	-25 °C ... +50 °C
Vibration resistance	5 g, 10 Hz ... 150 Hz (IEC 61496, IEC 61496-3)
Shock resistance	
Continuous shock	10 g, 16 ms (IEC 61496, IEC 61496-3)

Other information

Type of light	Pulsed laser diode
----------------------	--------------------

Wave length	905 nm
Detectable remission	1.8 % ... > 1,000 %, reflectors
Laser class	1 (21 CFR 1040.10 and 1040.11, IEC 60825-1)

Classifications

ECl@ss 5.0	27272705
ECl@ss 5.1.4	27272705
ECl@ss 6.0	27272705
ECl@ss 6.2	27272705
ECl@ss 7.0	27272705
ECl@ss 8.0	27272705
ECl@ss 8.1	27272705
ECl@ss 9.0	27272705
ETIM 5.0	EC002550
ETIM 6.0	EC002550
UNSPSC 16.0901	39121528

Dimensional drawing (Dimensions in mm (inch))

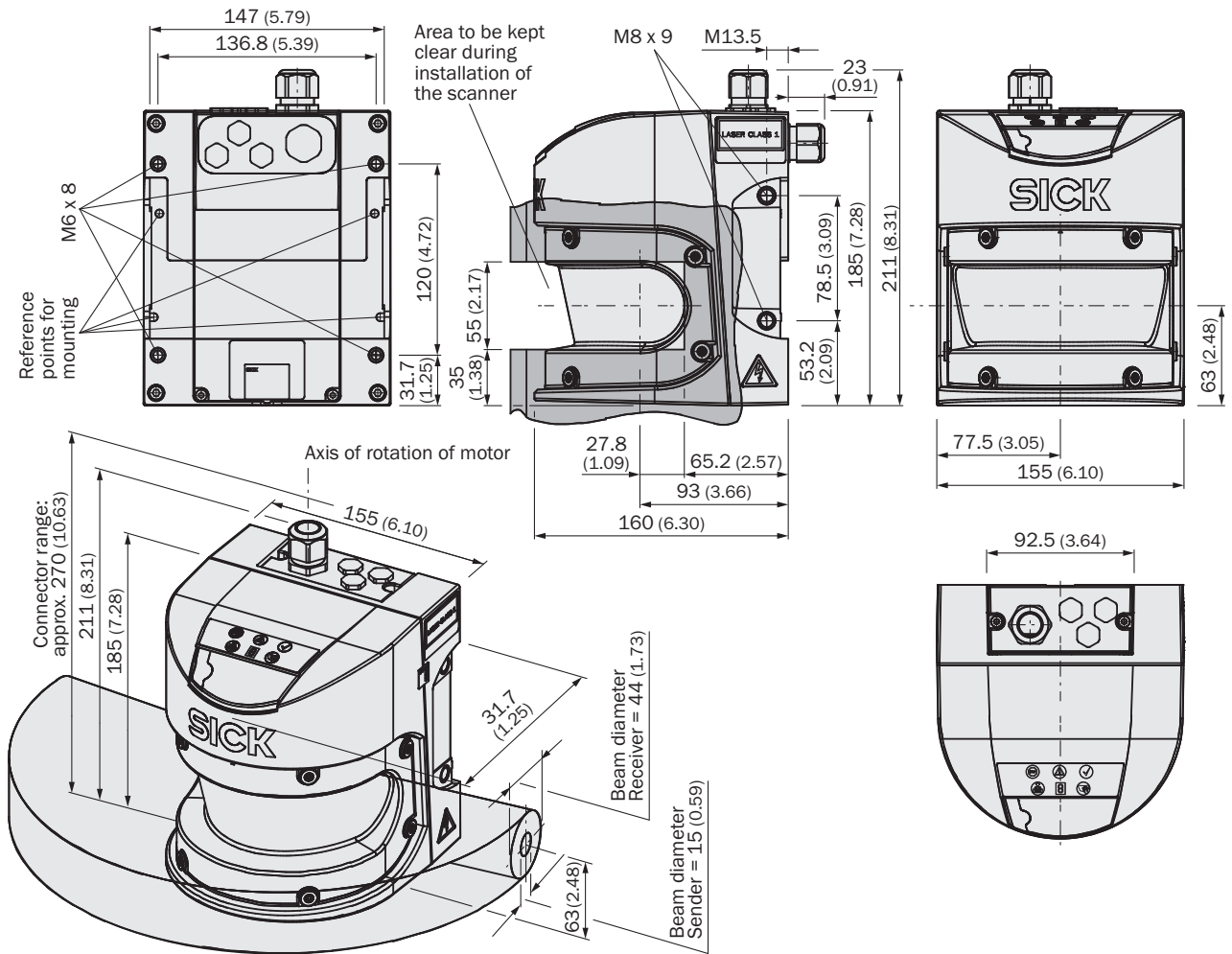

Connection diagram

S3000 standard with restart interlock and external device monitoring at UE10-30S safety relay

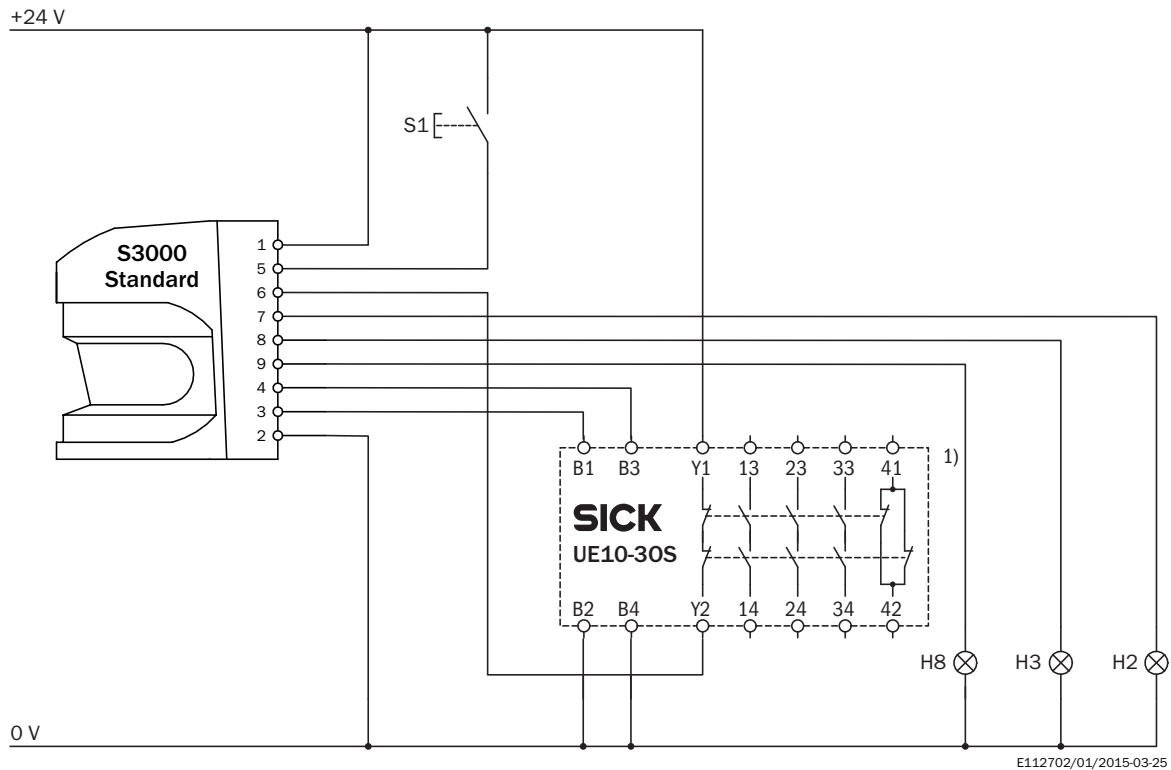

S3000 Standard in conjunction with UE10-30S

Operating mode: with restart interlock and external device monitoring (EDM)

Comments

¹⁾ Output circuits: These contacts are to be connected to the controller such that, with the output circuit open, the dangerous state is disabled. For categories 4 and 3, this integration must be dual-channel (x/y paths). Single-channel insertion in the control (z path) is only possible with a single-channel control and by taking the risk analysis into account.

S3000 Standard with restart interlock and external device monitoring

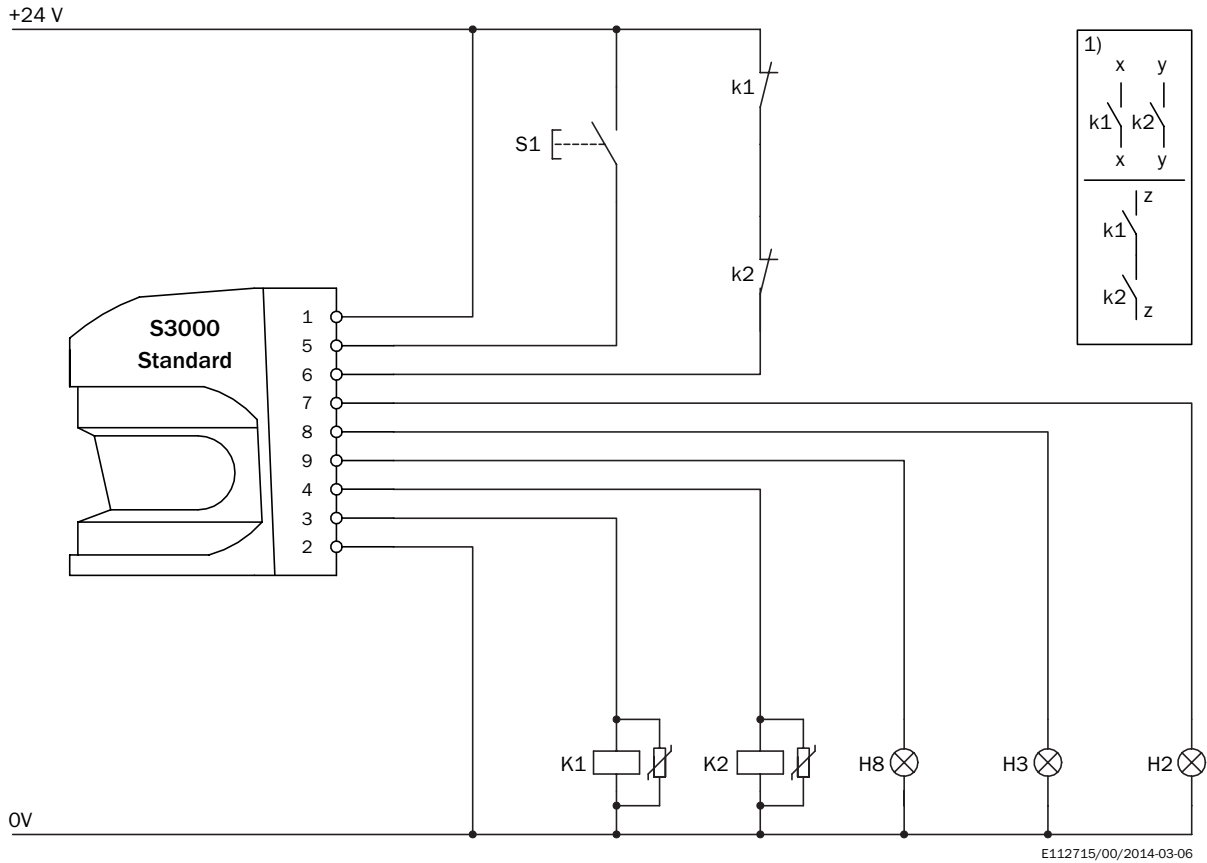

S3000 Standard in conjunction with relays/contactors



Operating mode: with restart interlock and external device monitoring (EDM)











Comments

¹⁾ Output circuits: These contacts are to be connected to the controller such that, with the output circuit open, the dangerous state is disabled. For categories 4 and 3, this integration must be dual-channel (x/y paths). Single-channel insertion in the control (z path) is only possible with a single-channel control and by taking the risk analysis into account.

Recommended accessories

Other models and accessories → www.sick.com/S3000_Standard

	Brief description	Type	Part no.
Mounting brackets and plates			
	1 piece, Visor for heavy duty mounting kit (2080350), steel, painted (RAL 1021)	Heavy duty sight	2083733
	1 piece, Mounting bracket, heavy-duty version, with protection cover, for floor mounting, adjustable longitudinal and lateral axes via alignment plate, height adjustment possible. Tilt angle ± 5°. Additional mounting brackets are not required., steel, painted (RAL 1021)	Heavy-duty mounting kit	2080350
	1 piece, mounting bracket for direct mounting, from the rear, on wall or machine, not adjustable	Mounting kit 1	2015623

	Brief description	Type	Part no.
	1 piece, mounting bracket for rear mounting on wall or machine, adjustable longitudinal and lateral axes, only in conjunction with mounting kit 1 (2015623)	Mounting kit 2	2015624
	1 piece, mounting bracket for rear mounting on wall, floor, or machine, adjustable longitudinal and lateral axes, only in conjunction with mounting kit 1 (2015623) and 2 (2015624)	Mounting kit 3	2015625
Plug connectors and cables			
	Head A: Flying leads Head B: Flying leads Cable: PVC, unshielded	Connecting cable	6022651
	Head A: Flying leads Head B: Flying leads Cable: PVC, shielded Fitting for EFI connections	EFI connecting cable	6029448
	Head A: male connector, M8, 4-pin, straight Head B: male connector, USB-A, straight Cable: PVC, unshielded, 2 m	DSL-8U04G02M025KM1	6034574
	Head A: male connector, M8, 4-pin, straight Head B: male connector, USB-A, straight Cable: PVC, unshielded, 10 m	DSL-8U04G10M025KM1	6034575
	Head A: system plug Cable: without cable Not for use of incremental encoders, integrated configuration storage	SX0A-A0000B	2023797
	Head A: system plug Cable: pre-assembled, Not for use of incremental encoders, integrated configuration storage, PVC, unshielded, 5 m	SX0A-B0905B	2027170
	Head A: system plug Cable: Pre-assembled, cable connection at the rear, Not for use of incremental encoders, integrated configuration storage, PVC, unshielded, 5 m	SX0A-B0905G	2049222
	Head A: system plug Cable: pre-assembled, Not for use of incremental encoders, integrated configuration storage, PVC, unshielded, 10 m	SX0A-B0910B	2027171
	Head A: system plug Cable: pre-assembled, Not for use of incremental encoders, integrated configuration storage, PVC, unshielded, 20 m	SX0A-B0920B	2027814

SICK AT A GLANCE

SICK is one of the leading manufacturers of intelligent sensors and sensor solutions for industrial applications. A unique range of products and services creates the perfect basis for controlling processes securely and efficiently, protecting individuals from accidents and preventing damage to the environment.

We have extensive experience in a wide range of industries and understand their processes and requirements. With intelligent sensors, we can deliver exactly what our customers need. In application centers in Europe, Asia and North America, system solutions are tested and optimized in accordance with customer specifications. All this makes us a reliable supplier and development partner.

Comprehensive services complete our offering: SICK LifeTime Services provide support throughout the machine life cycle and ensure safety and productivity.

For us, that is “Sensor Intelligence.”

WORLDWIDE PRESENCE:

Contacts and other locations www.sick.com