



Chipsmall Limited consists of a professional team with an average of over 10 year of expertise in the distribution of electronic components. Based in Hongkong, we have already established firm and mutual-benefit business relationships with customers from,Europe,America and south Asia,supplying obsolete and hard-to-find components to meet their specific needs.

With the principle of "Quality Parts,Customers Priority,Honest Operation,and Considerate Service",our business mainly focus on the distribution of electronic components. Line cards we deal with include Microchip,ALPS,ROHM,Xilinx,Pulse,ON,Everlight and Freescale. Main products comprise IC,Modules,Potentiometer,IC Socket,Relay,Connector.Our parts cover such applications as commercial,industrial, and automotives areas.

We are looking forward to setting up business relationship with you and hope to provide you with the best service and solution. Let us make a better world for our industry!



## Contact us

Tel: +86-755-8981 8866 Fax: +86-755-8427 6832

Email & Skype: info@chipsmall.com Web: www.chipsmall.com

Address: A1208, Overseas Decoration Building, #122 Zhenhua RD., Futian, Shenzhen, China



# Customer Information Sheet

DRAWING No.: S8201-46R

SHEET 2 OF 2

IF IN DOUBT - ASK

©

NOT TO SCALE

THIRD ANGLE PROJECTION

ALL DIMENSIONS IN mm

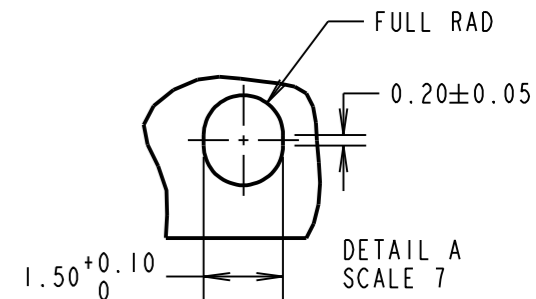
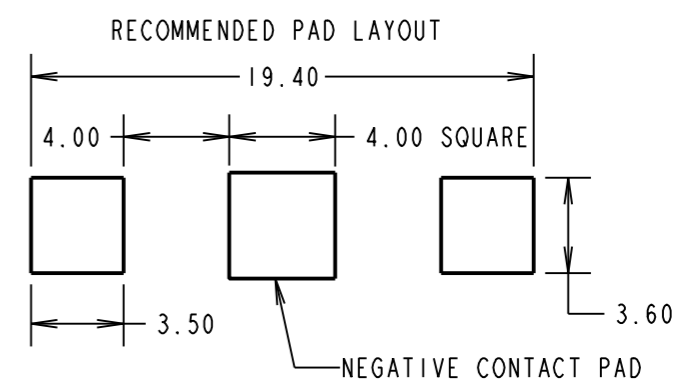
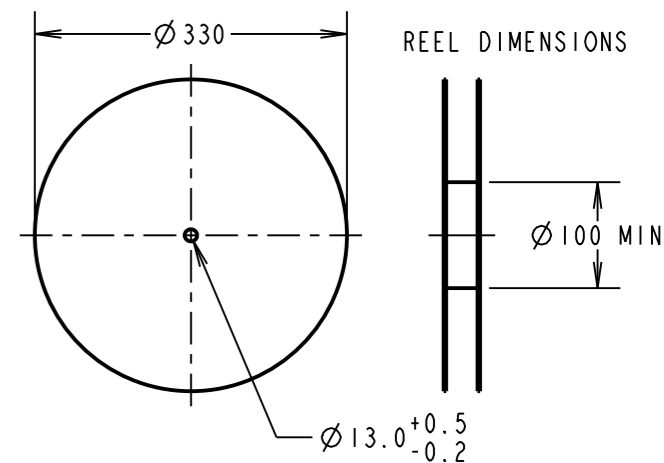
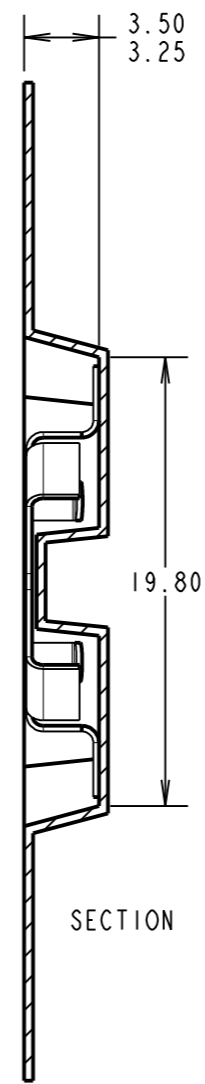
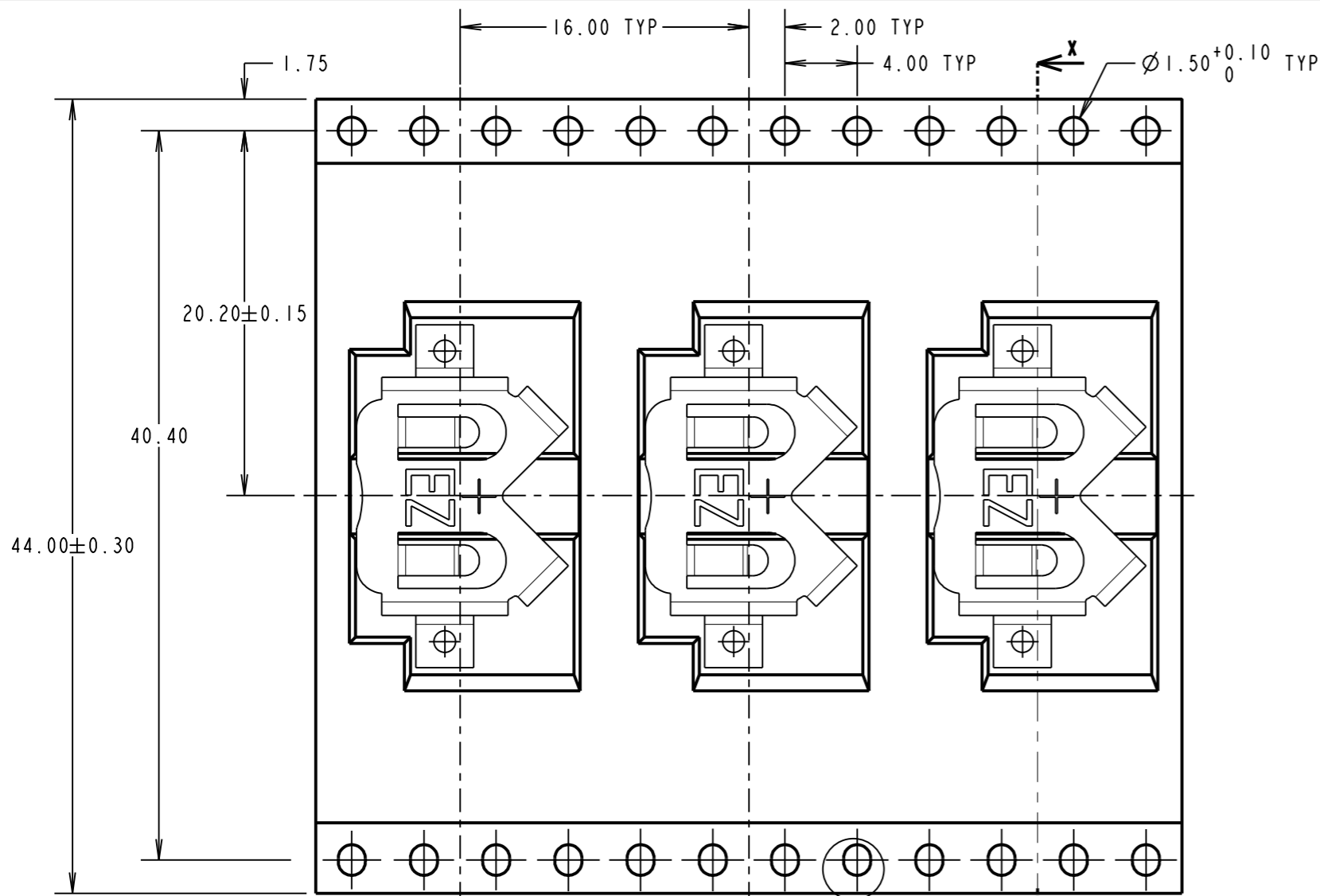

SINGLE COMPONENT DIMENSIONS

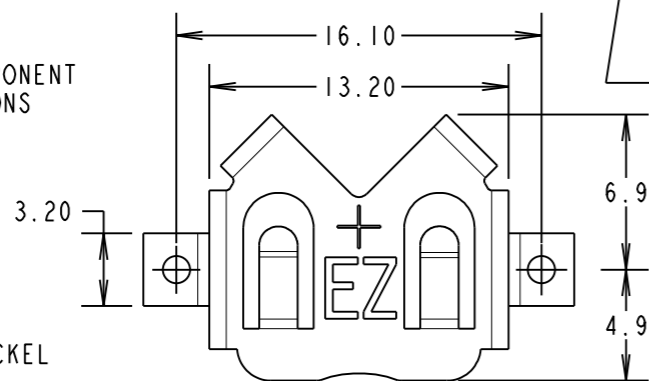

SEE DETAIL A

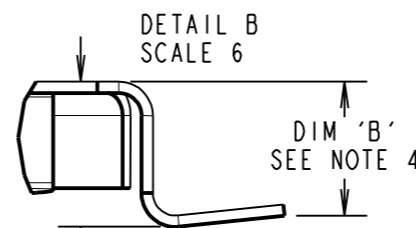

DETAIL B SCALE 6

DIM 'B' SEE NOTE 4

(DIM 'A') 3.20±0.05

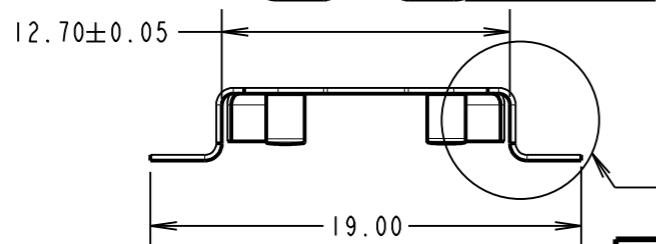

SEE DETAIL B

FINISHED REELING DIRECTION

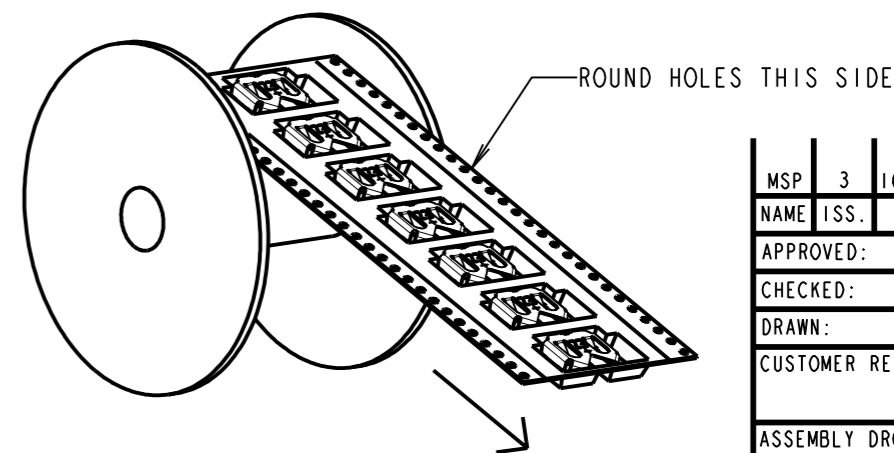

SPECIFICATION:  
MATERIAL = PHOSPHOR BRONZE  
FINISH:  
46 = 3µ 100% TIN, OVER NICKEL

- NOTES:
1. QUANTITY PER REEL = 1000.
  2. THIS PRODUCT IS TAPED AND REELED IN ACCORDANCE WITH EIA-481-2 (ELECTRONIC INDUSTRIES ASSOCIATION).
  3. THIS PRODUCT IS SUITABLE FOR THE FOLLOWING BATTERIES: BR1220, BR1225, CR1220 AND CR1225.
  4. DIM 'B' IS EQUAL OR UP TO 0.25mm LESS THAN MEASURED VALUE OF DIM 'A'.

MSP	3	16.12.15	13204
NAME	ISS.	DATE	C/NOTE
APPROVED:		M. PERREN	
CHECKED:		S. BENNETT	
DRAWN:		R. ADDE	
CUSTOMER REF.:			
ASSEMBLY DRG:			

**HARWIN**

www.harwin.com  
technical@harwin.com

THIS DRAWING AND ANY INFORMATION OR DESCRIPTIVE MATTER SET OUT HEREON ARE CONFIDENTIAL AND COPYRIGHT PROPERTY OF THE HARWIN GROUP AND MUST NOT BE DISCLOSED, LOANED, COPIED OR USED FOR MANUFACTURING, TENDERING OR FOR ANY OTHER PURPOSE WITHOUT THEIR WRITTEN PERMISSION.

TOLERANCES  
X. = ±1mm  
X.X = ±0.50mm  
X.XX = ±0.10mm  
X.XXX = ±0.01mm  
ANGLES = ±5°  
UNLESS STATED

MATERIAL:  
SEE ABOVE  
FINISH: SEE ABOVE  
S/AREA: mm<sup>2</sup>

TITLE:  
COIN CELL RETAINER (12mm)  
(TAPE & REELED)

DRAWING NUMBER:  
**S8201-46R**

SHT  
2 OF 2