



Chipsmall Limited consists of a professional team with an average of over 10 year of expertise in the distribution of electronic components. Based in Hongkong, we have already established firm and mutual-benefit business relationships with customers from,Europe,America and south Asia,supplying obsolete and hard-to-find components to meet their specific needs.

With the principle of "Quality Parts,Customers Priority,Honest Operation,and Considerate Service",our business mainly focus on the distribution of electronic components. Line cards we deal with include Microchip,ALPS,ROHM,Xilinx,Pulse,ON,Everlight and Freescale. Main products comprise IC,Modules,Potentiometer,IC Socket,Relay,Connector.Our parts cover such applications as commercial,industrial, and automotives areas.

We are looking forward to setting up business relationship with you and hope to provide you with the best service and solution. Let us make a better world for our industry!



Contact us

Tel: +86-755-8981 8866 Fax: +86-755-8427 6832

Email & Skype: info@chipsmall.com Web: www.chipsmall.com

Address: A1208, Overseas Decoration Building, #122 Zhenhua RD., Futian, Shenzhen, China



Uninterruptible Power Supply (UPS)

S8BA

Backup Power for 24-VDC Devices in Control Panels for Instantaneous Voltage Drops or Power Interruptions



- Small UPS for mounting on a DIN rail
- The S8BA solves due to momentary power losses and power failures
- DC-DC UPS for efficient backup

New Value For Control Panels

Control Panels: The Heart of Manufacturing Sites.

Evolution in control panels results in large evolution in production facilities.

And if control panel design, control panel manufacturing processes, and human interaction with them are innovated, control panel manufacturing becomes simpler and takes a leap forward.

OMRON will continue to achieve a control panel evolution and process innovation through many undertakings starting with the shared Value Design for Panel ^{*1} concept for the specifications of products used in control panels.

*1 Value Design for Panel



Our shared Value Design for Panel (herein after referred to as "Value Design") concept for the specifications of products used in control panels will create new value to our customer's control panels.
Combining multiple products that share the Value Design concept will further increase the value provided to control panels.

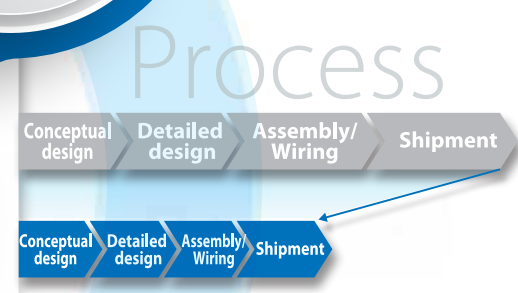

Panels

People



Backup Power for 24-VDC Devices in Control Panels for Instantaneous Voltage Drops or Power Interruptions

Small UPS for mounting on a DIN rail

Impressive Space Saving. Downsize Panels Even Further by Also Using Slim Power Supplies. Easy installation and wiring let you reduce assembly work.

Smallest in its class*1

Uninterruptible Power Supply (UPS)
S8BA-24D24D120LF (120 W)

Small and light UPS weighs only 800 grams*2
Light enough to mount dependably to DIN Rail.

CE LR*3
Support Exporting Overseas.

Lithium-ion Batteries*4
Life Expectancy: 10 yrs.*5
(replaceable battery)

Switch Mode Power Supply
S8VK-S (120 W)

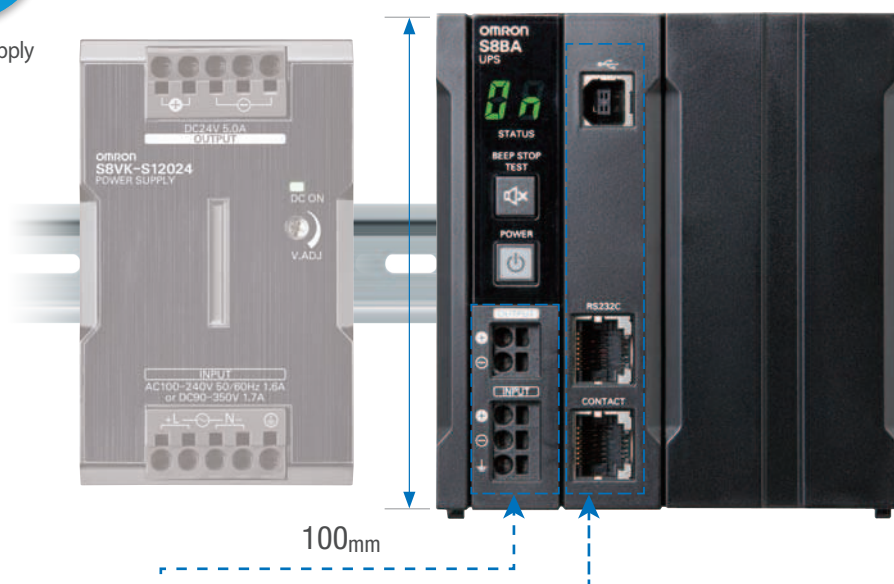

Plug-in Terminal Block
Just press bar terminals in for easy wiring

Connections through USB, RS-232C, and I/O ports enable interlock shutdown with an industrial PC (IPC) or controller.
Use any of 3 connection methods.*6

*1. In comparison of S8BA to products of the same class from other companies. According to OMRON investigation in March 2018.
*2. For the S8BA-24D24D120LF (120 W).
*3. Battery-integrated type only.

*4. Replacement Battery Pack sold separately.
*5. Ambient temperature 25°C. Expected life under standard usage conditions; not a guaranteed value.
*6. Refer to page 6.
Note: If a switching power supply will be installed in front of the UPS, take the connection load capacity and internal power consumption of the UPS into consideration when selecting the UPS.

A lineup of battery-integrated types and battery-separated types lets you select the optimum backup time.

Capacity	DC/DC UPS Battery-integrated type	DC/DC UPS Battery-separated type
960W (40A)		S8BA-24D24D960SBF + S8BA-S960L
480W (20A)	S8BA-24D24D480LF	S8BA-24D24D480SBF + S8BA-S480L
360W (15A)	S8BA-24D24D360LF	
240W (10A)	S8BA-24D24D240LF	
120W (5A)	S8BA-24D24D120LF	

The S8BA solves momentary power loss and power failure problems

Power Supply Problems Are All Too Familiar

Look how often lightning strikes! Lighting increases the risk of momentary power losses and power failures.

Lightning strikes occur more frequently than you might imagine.

Yearly Average Number of Days with Lightning Strikes Over the Past 10 Years Source: Japan Meteorological Agency

Region	Hokkaido	Tohoku	Hokuriku	Koshin'etsu	Kanto	Tokai	Kinki	Chugoku	Shikoku	Kyushu and Okinawa
Days	11.5	19.0	46.3	23.4	20.6	18.6	19.4	22.9	16.5	24.8

Momentary Power Interruptions or Power Interruptions Due to Natural Disasters or Local Conditions

Power interruptions can be caused by wind, rain, ice, snow, problems with power lines, accidents in factories, etc.

Voltage drops in factories can be caused by deterioration of facilities, high-volume motor operations in factories with expanded lines, etc.

Customer Problem

Line Stop Due to Lost Process Data

Problems with power lines caused instantaneous voltage drops in a factory, which reset the power supply to the Wireless Communications Unit that connects the PLC with the production management system and interrupted communications. This in turn caused the production management system to miss data, which resulted in line stops until the data could be recovered.

Solution

Interruptions in Communications Prevented with the S8BA

The S8BA was used to back up the power supply to the Wireless Communications Unit and PLC. This let process data be reliably communicated to the production management system, and lowered the risk of line stops.

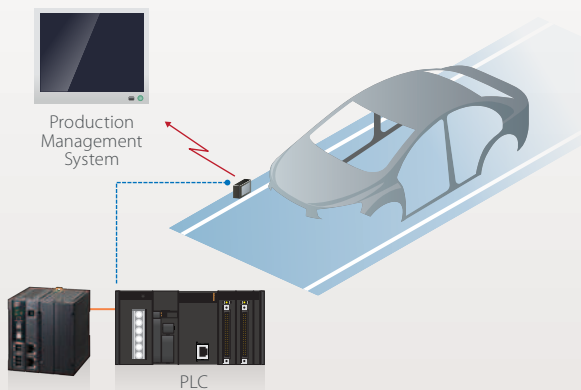

Example of S8BA Application

Location: Automobile factory
 Equipment: Production management system
 Connected devices: Wireless Communications Unit and PLC

Customer Problem

Loss of PC Data Due to Operating Errors

Maintenance technicians in a semiconductor manufacturing plant made procedural errors when stopping a device during equipment maintenance, causing the main power supply to suddenly turn OFF. The power supply to the PC used for SECS communications was turned OFF without shutting down the PC normally. This caused important data to be lost, and the factory suffered a long production stop.

Solution

S8BA Used to Enable Normal PC Shutdown

The S8BA was used to back up the power supply to the PC used for communications, and then the Simple Shutdown Software was installed on that PC. This prevented data losses during unexpected power interruptions by enabling the PC to shut down normally when power is lost. Also, the combination of a compact embedded PC with a compact UPS promoted device downsizing.

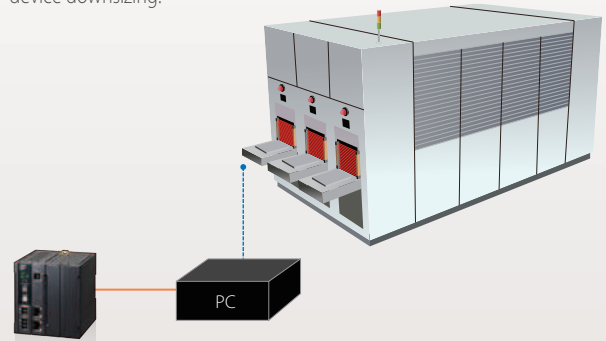

Example of S8BA Application

Location: Semiconductor manufacturing plant (post-process)
 Equipment: Semiconductor manufacturing device
 Connected device: PC

Problems with power supplies can also cause customers to lose confidence in you.

- System stoppages
- Damage to devices
- Data corruption

A UPS increases equipment stability and system reliability.



Customer Problem

Image Data Lost Due to Momentary Power Interruptions
 Image data is saved through a network to a host system to ensure traceability during printing inspection processes in a food factory, but an momentary power interruption due to a lightning strike reset the power supply to the image sensor and communications device, which prevented the image data from being saved to the host system.

Solution

Traceability Ensured with the S8BA

The S8BA was used to back up the power supplies to the image sensor and communications device. This allowed the system to continue to operate until the data is saved in the host system, which provided more-reliable traceability.

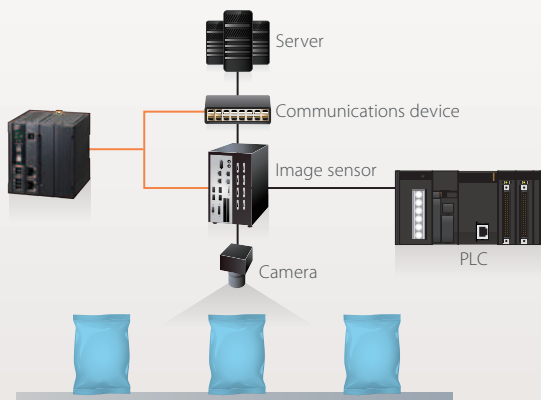

Example of S8BA Application

Location: Food factory
 Equipment: Image inspection devices
 Connected devices: Image sensor and communications device

Customer Problem

Loss of Valve Control Due to Power Interruption Caused by Lightning Strike
 A lightning strike during a summer storm caused a power interruption at a factory. Due to the power interruption, it became impossible to control the valve that maintains sterile conditions in pharmaceutical manufacturing equipment that requires maintenance of sterile conditions. During recovery from the power interruption, the valve opened before the clean fans started normal operation. Sterile conditions were lost, and production stopped for a long time until the sterile conditions could be restored.

Solution

Control Continued before and after a Power Interruption with the S8BA

The S8BA was used to back up the power supply to the valve. An I/O signal from the S8BA was used to communicate with the PLC valve open/close control after reaching a specific state during a power interruption or recovery to enable rapidly restarting production when recovering from a power interruption.

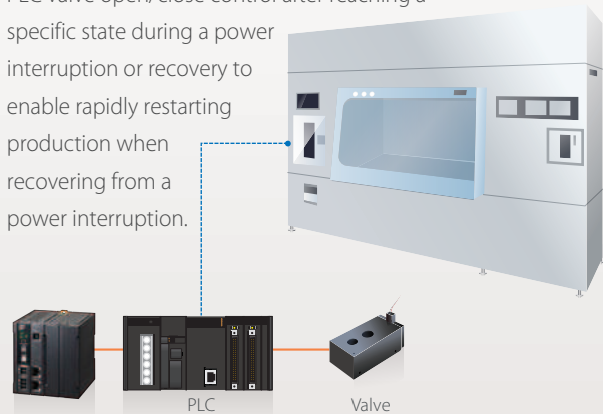

Example of S8BA Application

Location: Pharmaceuticals factory
 Equipment: Pharmaceutical manufacturing devices
 Connected devices: PLC and valve

DC-DC UPS for Efficient Backup

Three Features of the S8BA

Device Safety

Using a DC control section and building in the power section improves equipment safety.

Cost Reductions and Control Panel Downsizing

The use of a compact UPS allows you to downsize and build in the power section, which eliminates the need for a separate panel or wiring rack.

Reduced Work in Design and Management

All models are for 24 VDC to facilitate design, management, and maintenance.

Space-saving increases design freedom for the control panel and devices. Select the UPS with the optimum output capacity.

Greater Design Flexibility/Select the Optimum Output Capacity

AC-AC UPS

- This type of UPS is large, so it must be installed outside the control panel or it requires excessive space inside the control panel.
- All of the equipment connected to the Switch Mode Power Supply must be backed up, so you must install a UPS with a large output capacity.

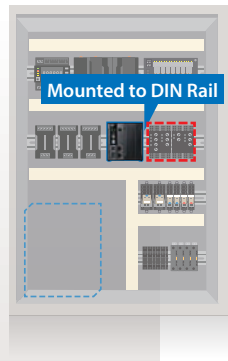
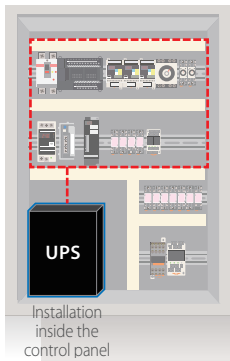

DC-DC UPS

- The compact body mounts to DIN Rail to save space. This increases design flexibility.
- With a DC-DC UPS, efficiency is increased because you can back up only the required equipment. You can select the UPS with the optimum output capacity.

Use Any of Three Connection Methods

USB/RS-232C



I/O Port

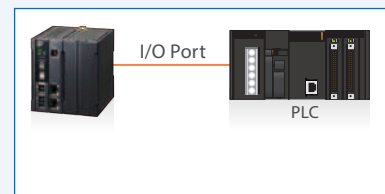

Automatic shutdown software for UPS: Simple Shutdown Software	Install the Simple Shutdown Software on a PC (Windows, Linux®, or other OS) that is connected to the UPS with a USB or RS-232C connection to automatically and safely shut down the PC when normal power is interrupted.
UPS Setting Utility Software	The UPS Setting Utility is a software application used to set up the UPS. You can use this software to easily change UPS settings.

• Windows is a registered trademark or trademark of the Microsoft Corporation in the U.S.A., Japan, and other countries.
 • Linux is a trademark or registered trademark of Linus Torvalds in the USA and other countries.

Ordering Information

Main body
Uninterruptible Power Supply (UPS) / Battery-integrated type

Input voltage	Output voltage	Output current / Power rating	Model
24 VDC	24 VDC	5A/120W	S8BA-24D24D120LF
		10A/240W	S8BA-24D24D240LF
		15A/360W	S8BA-24D24D360LF
		20A/480W *	S8BA-24D24D480LF

* The values are 16.7 A/400 W for use under UL standards.

Uninterruptible Power Supply (UPS) / Battery-separated type

• Control Unit Part

Input voltage	Output voltage	Output current / Power rating	Model
24 VDC	24 VDC	20A/480W	S8BA-24D24D480SBF
		40A/960W	S8BA-24D24D960SBF

• Battery unit part

Rated voltage	Rated capacity	Weight	Model
25.2 VDC	3900mAh	Approx. 1.5kg	S8BA-S480L
25.2 VDC	7800mAh	Approx. 2.5kg	S8BA-S960L

Note: The control unit (S8BA-24-D24D960SBF) and battery unit (S8BA-S480L) cannot be connected.

Connection Cable

Specifications	Type	Length	Model
For RS-232C port	RJ45/Dsub9Pin	2m	S8BW-C01
For CONTACT port	RJ45/Discrete wire		S8BW-C02

Replacement battery pack

Rated voltage	Rated capacity	Weight	Model
14.4 VDC	1600mAh	0.3kg	S8BA-B120L

Dimensions (Unit: mm)

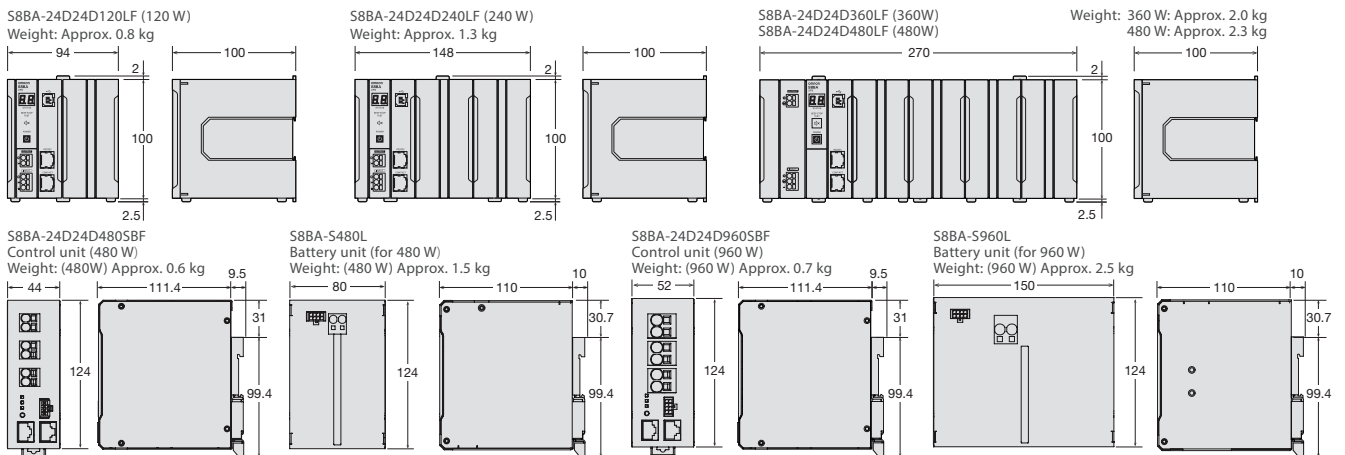

I/O signal functions

Type of output signals

Signal	Description
Backup signal output (BU)	Stays ON during backup operation at a power failure.
Battery LOW signal output (BL)	Goes ON when the battery becomes weak during backup operation at a power failure.
Trouble signal output (TR)	Goes ON when an internal failure of the UPS occurs or when the battery life counter expires.
Battery replacement signal output (WB)	Goes ON when the test determines that battery replacement is necessary due to deterioration or when the battery life counter goes off-scale.

Type of input signals

Signal	Description
Backup stop signal input (BS)	When the BS signal is ON (High), the output of the UPS is stopped after the time period specified in advance has elapsed. *
Remote ON/OFF signal	Remote ON/OFF signals can be used to start and stop the UPS, by using either an externally connected contact or the ON/OFF status of the open collector circuit. When signal is OFF, the UPS will be turned on. When signal is ON, the UPS will be turned off. In the factory settings, the UPS stops operation when this is short-circuited. In addition, it is necessary to turn on the "Power" switch of UPS to use this function.

* BS signal delay time: It is possible to set the period of time from when a BS signal is received until the output of the UPS is stopped. The output of the UPS can be stopped by inputting the voltage signal (High).

I/O signal port (RJ45 connector)

Outlook of the connector	Pin number	Cable color	Item
	1	White/orange	Backup signal output (BU)
	2	Orange	Remote ON/OFF input (-)
	3	White/green	Trouble signal output (TR)
	4	Blue	COMMON (COM)
	5	White/blue	Battery LOW signal output (BL)
	6	Green	Backup stop signal input (BS)
	7	White/brown	Battery replacement signal output (WB)
	8	Brown	Remote ON/OFF input (+)

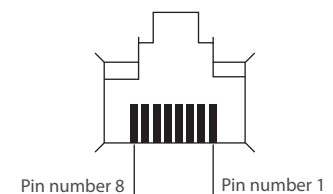

Backup time table (Time unit: minutes)

	Capacity (W)																	
	30	60	90	120	180	240	300	360	420	480	540	600	660	720	780	840	900	960
S8BA-24D24D120LF	29	14	9	6	-	-	-	-	-	-	-	-	-	-	-	-	-	-
S8BA-24D24D240LF	58	29	19	15	9	6	-	-	-	-	-	-	-	-	-	-	-	-
S8BA-24D24D360LF	87	43	28	22	14	10	8	6	-	-	-	-	-	-	-	-	-	-
S8BA-24D24D480LF	119	59	39	29	19	15	11	9	8	6	-	-	-	-	-	-	-	-
S8BA-24D24D480SBF + S8BA-S480L	134	63	41	29	19	15	11	9	8	6	-	-	-	-	-	-	-	-
S8BA-24D24D480SBF + S8BA-S960L	290	138	94	66	43	30	24	20	16	14	-	-	-	-	-	-	-	-
S8BA-24D24D960SBF + S8BA-S960L	290	138	94	66	43	30	24	20	16	14	13	12	11	10	9	8	7	6

Note: The above backup times are for reference only. They may change depending on the battery life and external environment (such as temperature).

Products That Create New Value in Control Panels



Switch Mode Power Supplies S8VK-S

Uninterruptible Power Supply (UPS) S8BA

Power Monitors KM-N2/KM-N3

Machine Automation Controllers NX Series NX1P

Measuring and Monitoring Relays K8DT

Solid-state Timers H3DT

Solid-state Timers H3Y(N)-B

Solid-state Timers H3RN-B

Liquid Leakage Sensor Amplifiers K7L-B

EtherCAT Slave Terminals NX Series NX-IO

Sockets for Relays with Forcibly Guided Contacts (for G7SA) P7SA-PU

Common Sockets (for MY/H3Y(N)-B) PYF-PU(L)

Common Sockets (for G2R-S/H3RN-B/K7L-B) P2RF-PU

Slim I/O Relays G2RV-SR

Slim I/O Relays G3RV-SR

I/O Relay Terminals G70V

DIN Track Terminal Blocks XW5T

Pushbutton Switches A22N-P/A30N-P/M22N-P

Emergency Stop Switches A22NE-P

Solid State Relays for Heaters G3PJ

Digital Temperature Controllers E5CC-B/E5EC-B

Digital Temperature Controllers E5CD-B/E5ED-B

Panel Assist Web

www.ia.omron.com/solution/panel/



Refer to the S8BA Uninterruptible Power Supply (UPS) Datasheet (Cat. No. U701) for details.

Before you place an order, please read and understand "Agreement for Using the Product" available on Omron's latest "Best control devices Omron," "General Brochure" or Omron's website.

OMRON Corporation Industrial Automation Company
Kyoto, JAPAN

Contact: www.ia.omron.com

Regional Headquarters

OMRON EUROPE B.V.
Wegalaan 67-69, 2132 JD Hoofddorp
The Netherlands
Tel: (31)2356-81-300/Fax: (31)2356-81-388

OMRON ASIA PACIFIC PTE. LTD.
No. 438A Alexandra Road # 05-05/08 (Lobby 2),
Alexandra Technopark,
Singapore 119967
Tel: (65) 6835-3011/Fax: (65) 6835-2711

OMRON ELECTRONICS LLC
2895 Greenspoint Parkway, Suite 200
Hoffman Estates, IL 60169 U.S.A.
Tel: (1) 847-843-7900/Fax: (1) 847-843-7787

OMRON (CHINA) CO., LTD.
Room 2211, Bank of China Tower,
200 Yin Cheng Zhong Road,
PuDong New Area, Shanghai, 200120, China
Tel: (86) 21-5037-2222/Fax: (86) 21-5037-2200

Authorized Distributor:

© OMRON Corporation 2015-2018 All Rights Reserved.
In the interest of product improvement,
specifications are subject to change without notice.
CSM_2_3_0518
Cat. No. **U700-E1-04** 0418 (0415)