



Chipsmall Limited consists of a professional team with an average of over 10 year of expertise in the distribution of electronic components. Based in Hongkong, we have already established firm and mutual-benefit business relationships with customers from,Europe,America and south Asia,supplying obsolete and hard-to-find components to meet their specific needs.

With the principle of “Quality Parts,Customers Priority,Honest Operation,and Considerate Service”,our business mainly focus on the distribution of electronic components. Line cards we deal with include Microchip,ALPS,ROHM,Xilinx,Pulse,ON,Everlight and Freescale. Main products comprise IC,Modules,Potentiometer,IC Socket,Relay,Connector.Our parts cover such applications as commercial,industrial, and automotives areas.

We are looking forward to setting up business relationship with you and hope to provide you with the best service and solution. Let us make a better world for our industry!



Contact us

Tel: +86-755-8981 8866 Fax: +86-755-8427 6832

Email & Skype: info@chipsmall.com Web: www.chipsmall.com

Address: A1208, Overseas Decoration Building, #122 Zhenhua RD., Futian, Shenzhen, China



Switch Mode Power Supply

S8EX (15, 30, 50, 100, 150, and 240-W Models)

Newly Released High-capacity 240-W Models in S8EX-series Lineup

Rated Output of 300 W for 200 VAC.*

* From 170 to 264 VAC.

New 240-W Models

- Lineup of models with 24-, 36-, and 48-VDC output voltages.

15-W, 35-W, 50-W, 100-W, and 150-W Models

- Lineup of models with from 5 to 48-VDC output voltages.

All Models

- Approved standards: UL60950-1, cUR CSA C22.2 No. 60950-1, EN 50178, and EN 60950-1
- Lineup includes open-frame models, models with chassis, and models with chassis and covers.
- Wide-range power supply: 100 to 240 VAC
- Complies with harmonic current standard in EN 61000-3-2 (50-W to 240-W models).
- The top class in industry for compact size.
- Boost current output (some models excluded).

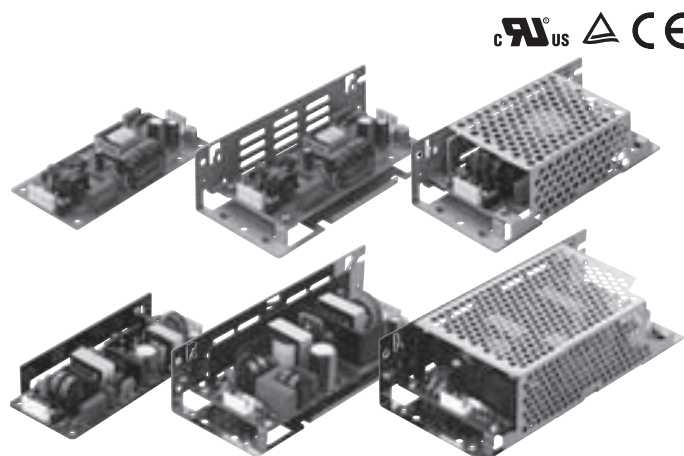

For the most recent information on models that have been certified for safety standards, refer to your OMRON website.

 Refer to *Safety Precautions* on page 22.

Model Number Structure

Model Number Legend

Note: Not all combinations are possible. Refer to *List of Models* in *Ordering Information* on page 2.

S8EX-□□□□□□□□-□□□□-□□
 1 2 3 4 5 6 7 8

1. Power Boost Function

- Blank: None
- B: Power boost for output current

2. Power Factor Improvement Function

- N: None
- P: Power factor improvement function provided *
 * Harmonic current standard: EN 61000-3-2 compliant.

3. Power Ratings

- 015: 15 W
- 030: 30 W
- 050: 50 W
- 100: 100 W
- 150: 150 W
- 240: 240 W

4. Output Voltage

- 05: 5 V
- 12: 12 V
- 15: 15 V
- 24: 24 V
- 36: 36 V
- 48: 48 V

5. Configuration

- None: Open-frame
- L: With chassis
- LC: With chassis and cover

6. Option 1

- None: Standard model
- CN1: XH connector (manufactured by J.S.T. Mfg. Co., Ltd.) *
 * This option is applicable only for 15-W models.

7. Option 2

- None: Standard model
- R: Remote control *
 * This option is applicable only for 50-W, 100-W, 150-W, and 240-W models.
 * This option is applicable only for open-frame models.

8. Option 3

- None: Standard model
- C: Coating (one side) *
 * This option is applicable only for open-frame models.

S8EX

Ordering Information

List of Models

Note: For details on normal stock models, contact your nearest OMRON representative.

Open frame



Power ratings	Output voltage	Output current	Boost current	Model
15 W	5 V	3 A	---	S8EX-N01505
	12 V	1.3 A		S8EX-N01512
	15 V	1 A		S8EX-N01515
	24 V	0.7 A		S8EX-N01524
	48 V	0.32 A		S8EX-N01548
30 W	5 V	6 A	---	S8EX-N03005
	12 V	2.5 A		S8EX-N03012
	15 V	2 A		S8EX-N03015
	24 V	1.3 A		S8EX-N03024
	48 V	0.65 A		S8EX-N03048
50 W	5 V	10 A	15 A	S8EX-BP05005
	12 V	4.3 A	6.5 A	S8EX-BP05012
	24 V	2.1 A	4.2 A	S8EX-BP05024
	48 V	1.1 A	2.2 A	S8EX-BP05048
100 W	5 V	20 A	---	S8EX-P10005
	12 V	8.5 A	12.8 A	S8EX-BP10012
	24 V	4.3 A	8.6 A	S8EX-BP10024
	48 V	2.1 A	4.2 A	S8EX-BP10048
150 W	5 V	30 A	---	S8EX-P15005
	12 V	12.5 A	18.8 A	S8EX-BP15012
	24 V	6.3 A	12.6 A	S8EX-BP15024
	48 V	3.2 A	6.4 A	S8EX-BP15048
240 W	24 V	10 A (100 VAC) 12.5 A (200 VAC)	20 A	S8EX-BP24024
	36 V	6.7 A (100 VAC) 8.4 A (200 VAC)	13.4 A	S8EX-BP24036
	48 V	5 A (100 VAC) 6.3 A (200 VAC)	10 A	S8EX-BP24048

Note: The input voltage is 100 to 240 VAC for all models.

With chassis



Power ratings	Output voltage	Output current	Boost current	Model
15 W	5 V	3 A	---	S8EX-N01505L
	12 V	1.3 A		S8EX-N01512L
	15 V	1 A		S8EX-N01515L
	24 V	0.7 A		S8EX-N01524L
	48 V	0.32 A		S8EX-N01548L
30 W	5 V	6 A	---	S8EX-N03005L
	12 V	2.5 A		S8EX-N03012L
	15 V	2 A		S8EX-N03015L
	24 V	1.3 A		S8EX-N03024L
	48 V	0.65 A		S8EX-N03048L
50 W	5 V	10 A	15 A	S8EX-BP05005L
	12 V	4.3 A	6.5 A	S8EX-BP05012L
	24 V	2.1 A	4.2 A	S8EX-BP05024L
	48 V	1.1 A	2.2 A	S8EX-BP05048L
100 W	5 V	20 A	---	S8EX-P10005L
	12 V	8.5 A	12.8 A	S8EX-BP10012L
	24 V	4.3 A	8.6 A	S8EX-BP10024L
	48 V	2.1 A	4.2 A	S8EX-BP10048L
150 W	5 V	30 A	---	S8EX-P15005L
	12 V	12.5 A	18.8 A	S8EX-BP15012L
	24 V	6.3 A	12.6 A	S8EX-BP15024L
	48 V	3.2 A	6.4 A	S8EX-BP15048L
240 W	24 V	10 A (100 VAC) 12.5 A (200 VAC)	20 A	S8EX-BP24024L
	36 V	6.7 A (100 VAC) 8.4 A (200 VAC)	13.4 A	S8EX-BP24036L
	48 V	5 A (100 VAC) 6.3 A (200 VAC)	10 A	S8EX-BP24048L

Note: The input voltage is 100 to 240 VAC for all models.

With chassis and cover



Power ratings	Output voltage	Output current	Boost current	Model
15 W	5 V	3 A	---	S8EX-N01505LC
	12 V	1.3 A		S8EX-N01512LC
	15 V	1 A		S8EX-N01515LC
	24 V	0.7 A		S8EX-N01524LC
	48 V	0.32 A		S8EX-N01548LC
30 W	5 V	6 A	---	S8EX-N03005LC
	12 V	2.5 A		S8EX-N03012LC
	15 V	2 A		S8EX-N03015LC
	24 V	1.3 A		S8EX-N03024LC
	48 V	0.65 A		S8EX-N03048LC
50 W	5 V	10 A	15 A	S8EX-BP05005LC
	12 V	4.3 A	6.5 A	S8EX-BP05012LC
	24 V	2.1 A	4.2 A	S8EX-BP05024LC
	48 V	1.1 A	2.2 A	S8EX-BP05048LC
100 W	5 V	20 A	---	S8EX-P10005LC
	12 V	8.5 A	12.8 A	S8EX-BP10012LC
	24 V	4.3 A	8.6 A	S8EX-BP10024LC
	48 V	2.1 A	4.2 A	S8EX-BP10048LC
150 W	5 V	30 A	---	S8EX-P15005LC
	12 V	12.5 A	18.8 A	S8EX-BP15012LC
	24 V	6.3 A	12.6 A	S8EX-BP15024LC
	48 V	3.2 A	6.4 A	S8EX-BP15048LC
240 W	24 V	10 A (100 VAC) 12.5 A (200 VAC)	20 A	S8EX-BP24024LC
	36 V	6.7 A (100 VAC) 8.4 A (200 VAC)	13.4 A	S8EX-BP24036LC
	48 V	5 A (100 VAC) 6.3 A (200 VAC)	10 A	S8EX-BP24048LC

Note: The input voltage is 100 to 240 VAC for all models.

Ratings, Characteristics, and Functions

Item	Power ratings		15 W					
	Output voltage		5 V	12 V	15 V	24 V	48 V	
Efficiency (Typ.)	100 VAC input		74%	77%	80%	80%	83%	
	200 VAC input		74%	77%	78%	78%	82%	
Input	Voltage *1		100 to 240 VAC (allowable voltage: 85 to 264 VAC or 120 to 370 VDC *6)					
	Frequency *1		50/60 Hz (47 to 450 Hz)					
	Current (Typ.)	100 VAC input		0.4 A				
		200 VAC input		0.25 A				
	Leakage current	100 VAC input		0.5 mA max.				
		200 VAC input		1 mA max.				
Inrush current (Typ.)	100 VAC input		15 A (for a cold start at 25°C)					
	200 VAC input		30 A (for a cold start at 25°C)					
Output	Voltage adjustment range *2		±10% (with V. ADJ)					
	Ripple *3		150 mV max.	240 mV max.	300 mV max.	480 mV max.	960 mV max.	
	Input variation influence		0.5% max. (with 85 to 264 VAC input at 100% load)					
	Load variation influence		2% max. (0 to 100% load, rated input voltage)		1.5% max. (0 to 100% load, rated input voltage)			
	Temperature variation influence		0.05%/°C max.					
	Startup time (Typ.)	100 VAC input		800 ms				
	Hold time (Typ.)	100 VAC input		20 ms				
Additional functions	Overload protection		105% to 160% of rated current, voltage drop, intermittent, and automatic reset					
	Overvoltage protection *4		Yes					
	Series operation		Yes (For up to two Power Supplies; external diodes required.)					
	Parallel operation		No (However, backup operation is possible; external diodes required.)					
Other	Ambient operating temperature		-10 to 70°C (Derating is required according to the temperature.) (with no icing or condensation)					
	Storage temperature		-25 to 75°C (with no icing or condensation)					
	Ambient operating humidity		25% to 85% (Storage humidity: 25% to 90%)					
	Dielectric strength		3.0 kVAC for 1 min. (between all inputs and outputs; Cutoff current: 10 mA) 2.0 kVAC for 1 min. (between all inputs and PE; Cutoff current: 10 mA) 1.0 kVAC for 1 min. (between all outputs and PE; Cutoff current: 20 mA)					
	Insulation resistance		100 MΩ min. (between all outputs and all inputs/PE terminal) at 500 VDC					
	Vibration resistance		10 to 55 Hz, 19.6 m/s ² (2 G) for 1 h each in X, Y, and Z directions					
	Shock resistance		196.1 m/s ² , 3 times each in ±X, ±Y, ±Z directions					
	EMI	Conducted Emissions		Conforms to EN 55011 Group 1 Class B *7				
		Radiated Emissions		Conforms to EN 55011 Group 1 Class B *7				
	EMS	Electrostatic Discharge		Conforms to EN61000-4-2				
		Radiated Electromagnetic Field		Conforms to EN61000-4-3				
		Electrical Fast Transient/Burst		Conforms to EN61000-4-4				
		Surge		Conforms to EN61000-4-5				
		Conducted Disturbance		Conforms to EN61000-4-6				
		Voltage Dips/Short Interruptions		Conforms to EN61000-4-11				
Approved standards		UL UR: UL 60950-1 (Recognition) cUR: CSA C22.2 No. 60950-1 EN: EN50178, EN60950-1						
SEMI		SEMI F47-0706 (at 200 VAC)						
Weight *5		70 g max. (without chassis and cover)						

- *1. Do not use an inverter output for the Power Supply. Inverters with an output frequency of 50/60 Hz are available, but the rise in the internal temperature of the Power Supply may result in ignition or burning.
- *2. If the output voltage adjuster (V. ADJ) is turned, the voltage will increase by +10% of the allowable voltage range. When adjusting the output voltage, confirm the actual output voltage from the Power Supply and be sure that load is not damaged.
- *3. Rated input voltage: 100 or 200 VAC at 100% load.
The measurement method is based on JEITA standard RC-9131A.
For details, refer to *Ripple Noise Voltage* on page 24.
- *4. To reset the protection after power is shut off, turn OFF the input power for three minutes or longer and then turn it back ON.
- *5. The weight is for an open-frame model.
- *6. The range for compliance with EC Directives and safety standards (UL, EN, etc.) is 100 to 240 VAC (85 to 264 VAC).
- *7. Class B compliance was met with an aluminum plate placed under the Power Supply.

Item	Power ratings		30 W					
	Output voltage		5 V	12 V	15 V	24 V	48 V	
Efficiency (Typ.)	100 VAC input		77%	82%	83%	85%	85%	
	200 VAC input		79%	83%	83%	86%	86%	
Input	Voltage *1		100 to 240 VAC (allowable voltage: 85 to 264 VAC, 120 to 370 VDC *6)					
	Frequency *1		50/60 Hz (47 to 450 Hz)					
	Current (Typ.)	100 VAC input		0.7 A				
		200 VAC input		0.4 A				
	Leakage current	100 VAC input		0.5 mA max.				
		200 VAC input		1mA max.				
Inrush current (Typ.)	100 VAC input		15 A (for a cold start at 25°C)					
	200 VAC input		30 A (for a cold start at 25°C)					
Output	Voltage adjustment range *2		±10% (with V. ADJ)					
	Ripple *3		150 mV max.	240 mV max.	300 mV max.	480 mV max.	960 mV max.	
	Input variation influence		0.5% max. (with 85 to 264 VAC input at 100% load)					
	Load variation influence		2% max. (0 to 100% load, rated input voltage)		1.5% max. (0 to 100% load, rated input voltage)			
	Temperature variation influence		0.05%/°C max.					
	Startup time (Typ.)	100 VAC input		800 ms				
	Hold time (Typ.)	100 VAC input		20 ms				
Additional functions	Overload protection		105% to 160% of rated current, voltage drop, intermittent, automatic reset					
	Overvoltage protection *4		Yes					
	Series operation		Yes (For up to two Power Supplies; external diodes required.)					
	Parallel operation		No (However, backup operation is possible; external diodes required.)					
Other	Ambient operating temperature		-10 to 70°C (Derating is required according to the temperature.) (with no icing or condensation)					
	Storage temperature		-25 to 75°C (with no icing or condensation)					
	Ambient operating humidity		25% to 85% (Storage humidity: 25% to 90%)					
	Dielectric strength		3.0 kVAC for 1 min. (between all inputs and outputs; Cutoff current: 10 mA) 2.0 kVAC for 1 min. (between all inputs and PE; Cutoff current: 10 mA) 1.0 kVAC for 1 min. (between all outputs and PE; Cutoff current: 20 mA)					
	Insulation resistance		100 MΩ min. (between all outputs and all inputs/PE terminal) at 500 VDC					
	Vibration resistance		10 to 55 Hz, 19.6 m/s ² (2 G) for 1 h each in X, Y, and Z directions					
	Shock resistance		196.1 m/s ² , 3 times each in ±X, ±Y, ±Z directions					
	EMI	Conducted Emissions		Conforms to EN 55011 Group 1 Class B *7				
		Radiated Emissions		Conforms to EN 55011 Group 1 Class B *7				
	EMS	Electrostatic Discharge		Conforms to EN61000-4-2				
		Radiated Electromagnetic Field		Conforms to EN61000-4-3				
		Electrical Fast Transient/Burst		Conforms to EN61000-4-4				
		Surge		Conforms to EN61000-4-5				
		Conducted Disturbance		Conforms to EN61000-4-6				
		Voltage Dips/Short Interruptions		Conforms to EN61000-4-11				
Approved standards		UL UR: UL 60950-1 (Recognition) cUR: CSA C22.2 No. 60950-1 EN: EN50178, EN60950-1						
SEMI		SEMI F47-0706 (at 200 VAC)						
Weight *5		110 g max. (without chassis and cover)						

- *1. Do not use an inverter output for the Power Supply. Inverters with an output frequency of 50/60 Hz are available, but the rise in the internal temperature of the Power Supply may result in ignition or burning.
- *2. If the output voltage adjuster (V. ADJ) is turned, the voltage will increase by +10% of the allowable voltage range. When adjusting the output voltage, confirm the actual output voltage from the Power Supply and be sure that load is not damaged.
- *3. Rated input voltage: 100 or 200 VAC at 100% load.
The measurement method is based on JEITA standard RC-9131A.
For details, refer to *Ripple Noise Voltage* on page 24.
- *4. To reset the protection after power is shut off, turn OFF the input power for three minutes or longer and then turn it back ON.
- *5. The weight is for an open-frame model.
- *6. The range for compliance with EC Directives and safety standards (UL, EN, etc.) is 100 to 240 VAC (85 to 264 VAC).
- *7. Class B compliance was met with an aluminum plate placed under the Power Supply.

Item	Power ratings		50 W				
	Output voltage		5 V	12 V	24 V	48 V	
Efficiency (Typ.)	100 VAC input		79%	83%	82%	82%	
	200 VAC input		81%	86%	85%	85%	
Input	Voltage *1		100 to 240 VAC (allowable voltage: 85 to 264 VAC, 120 to 370 VDC *6)				
	Frequency *1		50/60 Hz (47 to 63 Hz)				
	Current (Typ.)	100 VAC input	0.65 A				
		200 VAC input	0.35 A				
	Power factor (rate, 100% load)		0.9 min.				
	Harmonic current emissions		Conforms to EN 61000-3-2 Class A.				
	Leakage current	100 VAC input	0.5 mA max.				
		200 VAC input	1 mA max.				
Inrush current (Typ.)	100 VAC input	14.1 A (for a cold start at 25°C)					
	200 VAC input	28.3 A (for a cold start at 25°C)					
Output	Voltage adjustment range *2		±10% (with V. ADJ)				
	Ripple *3		150 mV max.	240 mV max.	480 mV max.	960 mV max.	
	Input variation influence		0.5% max. (with 85 to 264 VAC input at 100% load)				
	Load variation influence		2% max. (0 to 100% load, rated input voltage)	1.5% max. (0 to 100% load, rated input voltage)			
	Temperature variation influence		0.05%/°C max.				
	Startup time (Typ.)	100 VAC input	440 ms	460 ms	500 ms	460 ms	
	Hold time (Typ.)	100 VAC input	25 ms	20 ms	23 ms	22 ms	
Additional functions	Overload protection		100% to 110% of rated load current, voltage drop, intermittent, automatic reset				
	Overvoltage protection *4		Yes				
	Series operation		Yes (For up to two Power Supplies; external diodes required.)				
	Parallel operation		No (However, backup operation is possible; external diodes required.)				
	Remote control		Yes (Only for models with remote control option.)				
Other	Ambient operating temperature		-10 to 70°C (Derating is required according to the temperature.) (with no icing or condensation)				
	Storage temperature		-25 to 75°C (with no icing or condensation)				
	Ambient operating humidity		25% to 85% (Storage humidity: 25% to 90%)				
	Dielectric strength		3.0 kVAC for 1 min. (between all inputs and outputs; Cutoff current: 10 mA) 2.0 kVAC for 1 min. (between all inputs and PE; Cutoff current: 10 mA) 1.0 kVAC for 1 min. (between all outputs and PE; Cutoff current: 20 mA)				
	Insulation resistance		100 MΩ min. (between all outputs and all inputs/PE terminal) at 500 VDC				
	Vibration resistance		10 to 55 Hz, 19.6 m/s ² (2 G) for 1 h each in X, Y, and Z directions				
	Shock resistance		196.1 m/s ² , 3 times each in ±X, ±Y, ±Z directions				
	EMI	Conducted Emissions		Conforms to EN 55011 Group 1 Class B *7			
		Radiated Emissions		Conforms to EN 55011 Group 1 Class B *7			
	EMS	Electrostatic Discharge		Conforms to EN61000-4-2			
		Radiated Electromagnetic Field		Conforms to EN61000-4-3			
		Electrical Fast Transient/Burst		Conforms to EN61000-4-4			
		Surge		Conforms to EN61000-4-5			
		Conducted Disturbance		Conforms to EN61000-4-6			
		Voltage Dips/Short Interruptions		Conforms to EN61000-4-11			
Approved standards		UL UR: UL 60950-1 (Recognition) cUR: CSA C22.2 No. 60950-1 EN: EN50178, EN60950-1					
SEMI		SEMI F47-0706 (at 200 VAC)					
Weight *5		150 g max. (without chassis and cover)					

*1. Do not use an inverter output for the Power Supply. Inverters with an output frequency of 50/60 Hz are available, but the rise in the internal temperature of the Power Supply may result in ignition or burning.

*2. If the output voltage adjuster (V. ADJ) is turned, the voltage will increase by +10% of the allowable voltage range. When adjusting the output voltage, confirm the actual output voltage from the Power Supply and be sure that load is not damaged.

*3. Rated input voltage: 100 or 200 VAC at 100% load.

The measurement method is based on JEITA standard RC-9131A.

For details, refer to *Ripple Noise Voltage* on page 24.

*4. To reset the protection after power is shut off, turn OFF the input power for three minutes or longer and then turn it back ON.

*5. The weight is for an open-frame model.

*6. The range for compliance with EC Directives and safety standards (UL, EN, etc.) is 100 to 240 VAC (85 to 264 VAC).

*7. Class B compliance was met with an aluminum plate placed under the Power Supply.

Item		Power ratings		100 W			
		Output voltage		5 V	12 V	24 V	48 V
Efficiency (Typ.)		100 VAC input		81%	82%	84%	84%
		200 VAC input		84%	85%	86%	86%
Input	Voltage *1		100 to 240 VAC (allowable voltage: 85 to 264 VAC, 120 to 370 VDC *6)				
	Frequency *1		50/60 Hz (47 to 63 Hz)				
	Current (Typ.)	100 VAC input		1.3 A			
		200 VAC input		0.65 A			
	Power factor (rate, 100% load)		0.9 min.				
	Harmonic current emissions		Conforms to EN 61000-3-2 Class A.				
	Leakage current	100 VAC input		0.5 mA max.			
		200 VAC input		1 mA max.			
Inrush current (Typ.)	100 VAC input		14.1 A (for a cold start at 25°C)				
	200 VAC input		28.3 A (for a cold start at 25°C)				
Output	Voltage adjustment range *2		±10% (with V. ADJ)				
	Ripple *3		150 mV max.	240 mV max.	480 mV max.	960 mV max.	
	Input variation influence		0.5% max. (with 85 to 264 VAC input at 100% load)				
	Load variation influence		2% max. (0 to 100% load, rated input voltage)		1.5% max. (0 to 100% load, rated input voltage)		
	Temperature variation influence		0.05%/°C max.				
	Startup time (Typ.)	100 VAC input		480 ms	530 ms	540 ms	650 ms
		200 VAC input		24 ms	21 ms	22 ms	24 ms
	Additional functions	Overload protection		12-V, 24-V, or 48-V model: 100% to 110% of power boost for output current, voltage drop, intermittent, automatic reset 5-V model: 105% to 160% of rated current, voltage drop, intermittent, automatic reset			
Overvoltage protection *4		Yes					
Series operation		Yes (For up to two Power Supplies; external diodes required.)					
Parallel operation		No (However, backup operation is possible; external diodes required.)					
Remote control		Yes (Only for models with remote control option.)					
Other	Ambient operating temperature		-10 to 70°C (Derating is required according to the temperature.) (with no icing or condensation)				
	Storage temperature		-25 to 75°C (with no icing or condensation)				
	Ambient operating humidity		25% to 85% (Storage humidity: 25% to 90%)				
	Dielectric strength		3.0 kVAC for 1 min. (between all inputs and outputs; Cutoff current: 10 mA) 2.0 kVAC for 1 min. (between all inputs and PE; Cutoff current: 10 mA) 1.0 kVAC for 1 min. (between all outputs and PE; Cutoff current: 20 mA)				
	Insulation resistance		100 MΩmin. (between all outputs and all inputs/PE terminal) at 500 VDC				
	Vibration resistance		10 to 55 Hz, 19.6 m/s ² (2 G) for 1 h each in X, Y, and Z directions				
	Shock resistance		196.1 m/s ² , 3 times each in ±X, ±Y, ±Z directions				
	EMI	Conducted Emissions		Conforms to EN 55011 Group 1 Class B *7			
		Radiated Emissions		Conforms to EN 55011 Group 1 Class B *7			
	EMS	Electrostatic Discharge		Conforms to EN61000-4-2			
		Radiated Electromagnetic Field		Conforms to EN61000-4-3			
		Electrical Fast Transient/Burst		Conforms to EN61000-4-4			
		Surge		Conforms to EN61000-4-5			
		Conducted Disturbance		Conforms to EN61000-4-6			
	Voltage Dips/Short Interruptions		Conforms to EN61000-4-11				
Approved standards		UL UR: UL 60950-1 (Recognition) cUR: CSA C22.2 No. 60950-1 EN: EN50178, EN60950-1					
SEMI		SEMI F47-0706 (at 200 VAC)					
Weight *5		265 g max. (without chassis and cover)					

- *1. Do not use an inverter output for the Power Supply. Inverters with an output frequency of 50/60 Hz are available, but the rise in the internal temperature of the Power Supply may result in ignition or burning.
- *2. If the output voltage adjuster (V. ADJ) is turned, the voltage will increase by +10% of the allowable voltage range. When adjusting the output voltage, confirm the actual output voltage from the Power Supply and be sure that load is not damaged.
- *3. Rated input voltage: 100 or 200 VAC at 100% load.
The measurement method is based on JEITA standard RC-9131A.
For details, refer to *Ripple Noise Voltage* on page 24.
- *4. To reset the protection after power is shut off, turn OFF the input power for three minutes or longer and then turn it back ON.
- *5. The weight is for an open-frame model.
- *6. The range for compliance with EC Directives and safety standards (UL, EN, etc.) is 100 to 240 VAC (85 to 264 VAC).
- *7. Class B compliance was met with an aluminum plate placed under the Power Supply.

Item	Power ratings		150 W				
	Output voltage		5 V	12 V	24 V	48 V	
Efficiency (Typ.)	100 VAC input		84%	83%	84%	85%	
	200 VAC input		87%	86%	87%	88%	
Input	Voltage *1		100 to 240 VAC (allowable voltage: 85 to 264 VAC, 120 to 370 VDC *6)				
	Frequency *1		50/60 Hz (47 to 63 Hz)				
	Current (Typ.)	100 VAC input	1.9 A				
		200 VAC input	0.95 A				
	Power factor (rate, 100% load)		0.9 min.				
	Harmonic current emissions		Conforms to EN 61000-3-2 Class A.				
	Leakage current	100 VAC input	0.5 mA max.				
		200 VAC input	1 mA max.				
Inrush current (Typ.)	100 VAC input	14.1 A (for a cold start at 25°C)					
	200 VAC input	28.3 A (for a cold start at 25°C)					
Output	Voltage adjustment range *2		±10% (with V. ADJ)				
	Ripple *3		150 mV max.	240 mV max.	480 mV max.	960 mV max.	
	Input variation influence		0.5% max. (with 85 to 264 VAC input at 100% load)				
	Load variation influence		2% max. (0 to 100% load, rated input voltage)	1.5% max. (0 to 100% load, rated input voltage)			
	Temperature variation influence		0.05%/°C max.				
	Startup time (Typ.)	100 VAC input	450 ms	660 ms	660 ms	690 ms	
		Hold time (Typ.)	100 VAC input	25 ms	20 ms	21 ms	20 ms
Additional functions	Overload protection		12-V, 24-V, or 48-V model: 100% to 110% of power boost for output current, voltage drop, intermittent, automatic reset 5-V model: 105% to 160% of rated current, voltage drop, intermittent, automatic reset				
	Overvoltage protection *4		Yes				
	Series operation		Yes (For up to two Power Supplies; external diodes required.)				
	Parallel operation		No (However, backup operation is possible; external diodes required.)				
Remote control		Yes (Only for models with remote control option.)					
Other	Ambient operating temperature		-10 to 70°C (Derating is required according to the temperature.) (with no icing or condensation)				
	Storage temperature		-25 to 75°C (with no icing or condensation)				
	Ambient operating humidity		25% to 85% (Storage humidity: 25% to 90%)				
	Dielectric strength		3.0 kVAC for 1 min. (between all inputs and outputs; Cutoff current: 10 mA) 2.0 kVAC for 1 min. (between all inputs and PE; Cutoff current: 10 mA) 1.0 kVAC for 1 min. (between all outputs and PE; Cutoff current: 20 mA)				
	Insulation resistance		100 MΩ min. (between all outputs and all inputs/PE terminal) at 500 VDC				
	Vibration resistance		10 to 55 Hz, 19.6 m/s ² (2 G) for 1 h each in X, Y, and Z directions				
	Shock resistance		196.1 m/s ² , 3 times each in ±X, ±Y, ±Z directions				
	EMI	Conducted Emissions		Conforms to EN 55011 Group 1 Class B *7			
		Radiated Emissions		Conforms to EN 55011 Group 1 Class B *7			
	EMS	Electrostatic Discharge		Conforms to EN61000-4-2			
		Radiated Electromagnetic Field		Conforms to EN61000-4-3			
		Electrical Fast Transient/Burst		Conforms to EN61000-4-4			
		Surge		Conforms to EN61000-4-5			
		Conducted Disturbance		Conforms to EN61000-4-6			
Voltage Dips/Short Interruptions		Conforms to EN61000-4-11					
Approved standards		UL UR: UL 60950-1 (Recognition) cUR: CSA C22.2 No. 60950-1 EN: EN50178, EN60950-1					
SEMI		SEMI F47-0706 (at 200 VAC)					
Weight *5		315 g max. (without chassis and cover)					

*1. Do not use an inverter output for the Power Supply. Inverters with an output frequency of 50/60 Hz are available, but the rise in the internal temperature of the Power Supply may result in ignition or burning.

*2. If the output voltage adjuster (V. ADJ) is turned, the voltage will increase by +10% of the allowable voltage range. When adjusting the output voltage, confirm the actual output voltage from the Power Supply and be sure that load is not damaged.

*3. Rated input voltage: 100 or 200 VAC at 100% load.
The measurement method is based on JEITA standard RC-9131A.
For details, refer to *Ripple Noise Voltage* on page 24.

*4. To reset the protection after power is shut off, turn OFF the input power for three minutes or longer and then turn it back ON.

*5. The weight is for an open-frame model.

*6. The range for compliance with EC Directives and safety standards (UL, EN, etc.) is 100 to 240 VAC (85 to 264 VAC).

*7. Class B compliance was met with an aluminum plate placed under the Power Supply.

Item	Power ratings Output voltage		240 W (300 W)			
			24 V	36 V	48 V	
Efficiency (Typ.)	100 VAC input		87%	87%	87%	
	200 VAC input		90%	90%	90%	
Input	Voltage *1		100 to 240 VAC (allowable voltage: 85 to 264 VAC, 120 to 370 VDC *6)			
	Frequency *1		50/60 Hz (47 to 63 Hz)			
	Current (Typ.)	100 VAC input	2.9 A (for 240-W output)			
		200 VAC input	1.5 A (for 240-W output) 1.8 A (for 300-W output)			
	Power factor (rate, 100% load)		0.9 min.			
	Harmonic current emissions		Conforms to EN 61000-3-2 Class A.			
	Leakage current	100 VAC input	0.5 mA max.			
		200 VAC input	1.0 mA max.			
Inrush current (Typ.)	100 VAC input	14 A (for a cold start at 25°C)				
	200 VAC input	28 A (for a cold start at 25°C)				
Output	Voltage adjustment range *2		±10% (with V. ADJ)			
	Ripple *3		480 mV max.	720 mV max.	960 mV max.	
	Input variation influence		0.5% max.			
	Load variation influence		1.5% max.			
	Temperature variation influence		0.05%/°C max.			
	Startup time (Typ.)	100 VAC input	460 ms			
		200 VAC input	330 ms			
	Hold time (Typ.)	100 VAC input	20 ms (for output power of 240 W)			
200 VAC input		20 ms (for output power of 240 W) 16 ms (for output power of 300 W)				
Additional functions	Overload protection *4		100% or higher of power boost for output current, voltage drop, automatic reset Power shut off if 130% or higher of rated output current continues for approx. 5 s Reset by input reset (OFF time: 3 min min.)			
	Overvoltage protection *4		Yes			
	Series operation		Yes (For up to two Power Supplies; external diodes are required.)			
	Parallel operation		No (However, backup operation is possible; external diodes required.)			
	Remote control		Yes (Only for models with remote control option.)			
Undervoltage alarm output		Yes (open-collector output, 30 VDC max., 50 mA max.)				
Other	Ambient operating temperature		-10 to 70°C (Derating is required according to the temperature.) (with no icing or condensation)			
	Storage temperature		-25 to 75°C (with no icing or condensation)			
	Ambient operating humidity		25% to 85%			
	Dielectric strength		3.0 kVAC for 1 min. (between all inputs and outputs; Cutoff current: 10 mA) 2.0 kVAC for 1 min. (between all inputs and PE; Cutoff current: 10 mA) 1.0 kVAC for 1 min. (between all outputs and PE; Cutoff current: 20 mA)			
	Insulation resistance		100 MΩ min. (between all outputs and all inputs/PE terminal) at 500 VDC (at room temperature 25°C and humidity 60%)			
	Vibration resistance		No abnormality after 10 to 55 Hz, 19.6 m/s ² (2 G) for 1 h each in X, Y, and Z directions.			
	Shock resistance		196.1 m/s ² , 3 times each in ±X, ±Y, ±Z directions			
	EMI	Conducted Emissions		Conforms to EN 55011 Group 1 Class B *7		
		Radiated Emissions		Conforms to EN 55011 Group 1 Class B *7*8		
	EMS	Electrostatic Discharge		Conforms to EN61000-4-2		
		Radiated Electromagnetic Field		Conforms to EN61000-4-3		
Electrical Fast Transient/Burst		Conforms to EN61000-4-4				
Surge		Conforms to EN61000-4-5				
Conducted Disturbance		Conforms to EN61000-4-6				
Voltage Dips/Short Interruptions		Conforms to EN61000-4-11				
Approved standards		UL UR: UL 60950-1 (Recognition) cUR: CSA C22.2 No. 60950-1 EN: EN50178, EN60950-1				
SEMI		SEMI F47-0706 (at 200 VAC)				
Weight *5		515 g (without chassis and cover)				

*1. Do not use an inverter output for the Power Supply. Inverters with an output frequency of 50/60 Hz are available, but the rise in the internal temperature of the Power Supply may result in ignition or burning.
 *2. If the output voltage adjuster (V. ADJ) is turned, the voltage will increase by +10% of the allowable voltage range. When adjusting the output voltage, confirm the actual output voltage from the Power Supply and be sure that load is not damaged.
 *3. Rated input voltage: 100 or 200 VAC at 100% load.
 The measurement method is based on JEITA standard RC-9131A. For details, refer to *Ripple Noise Voltage* on page 24.
 *4. To reset the protection after power is shut off, turn OFF the input power for three minutes or longer and then turn it back ON.
 *5. The weight is for an open-frame model.
 *6. The range for compliance with EC Directives and safety standards (UL, EN, etc.) is 100 to 240 VAC (85 to 264 VAC).
 *7. Noise values depend on the wiring methods. Class B compliance was met with an aluminum plate placed under the Power Supply.
 *8. Insert filters (ZCAT3035-1330 manufactured by TDK Corporation) in the input and output lines to reduce noise.

Connections

Block Diagrams

S8EX-N015□□ (15 W)
S8EX-N030□□ (30 W)

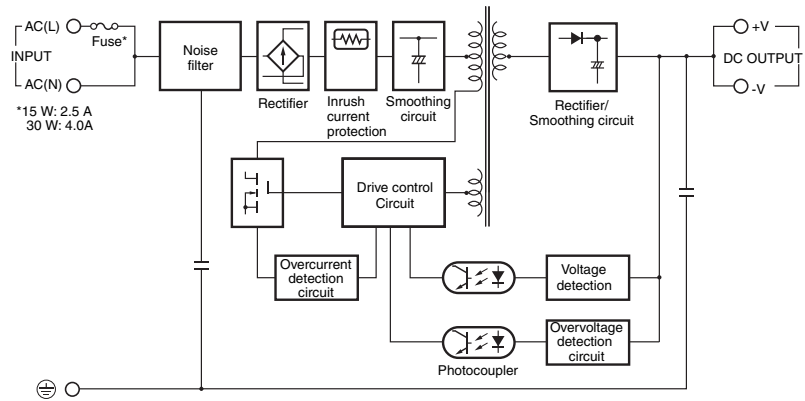

S8EX-BP050□□ (50 W)
S8EX-□P100□□ (100 W)
S8EX-□P150□□ (150 W)

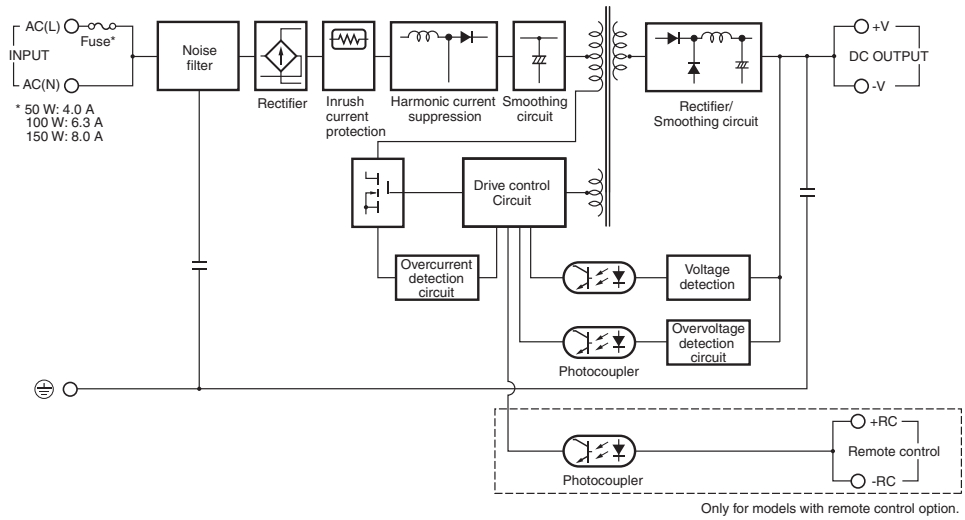

S8EX-BP240□□ (240 W)

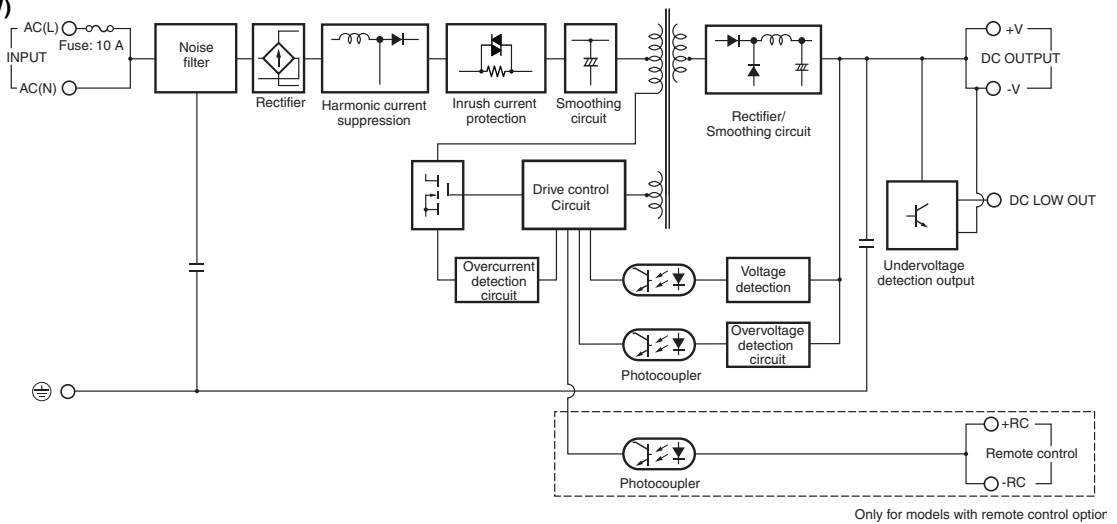

S8EX

Construction and Nomenclature

Nomenclature

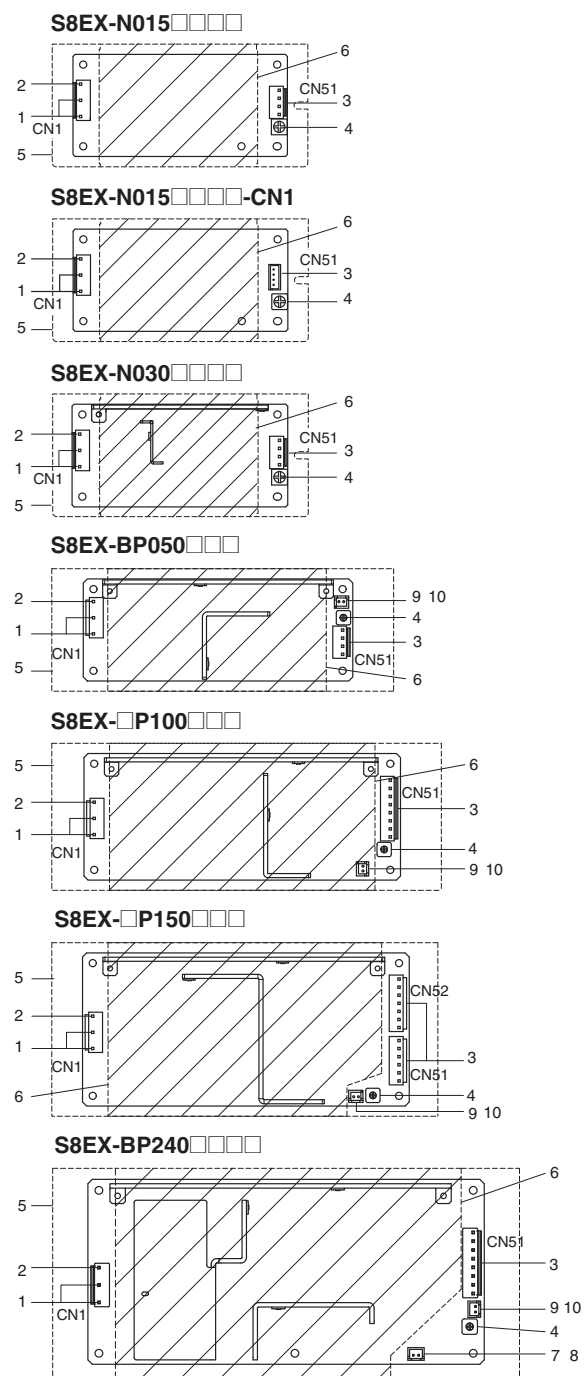

No.	Name	Function
1	Input Terminals (L), (N)	Connect the input lines to these terminals. *1
2	Protective Earth Terminal (PE)	Connect the ground line to these terminals. *2
3	DC Output Terminals (-V), (+V)	Connect the load lines to these terminals.
4	Output Voltage Adjuster (V. ADJ)	It is possible to increase or decrease the output voltage.
5	Chassis	
6	Cover	
7	Undervoltage alarm output collector terminal (DC LOW)	Output a signal when a low output voltage is detected.
8	Undervoltage alarm output emitter terminal (DC LOW)	
9	Remote control +RC terminal *3	Wire for remote control.
10	Remote control -RC terminal *3	

*1. The fuse is located on the (L) side. It is NOT user-replaceable. For a DC power input, connect the low side to the positive (+) terminal. Safety standards do not apply for a DC input.

*2. This is the protective earth terminal specified in the safety standards. Always ground this terminal.

*3. Only for models with remote control option.

Input and Output Connectors

			Applicable connector	Housing	Terminals	Applicable crimp tool
Input side	All models	CN1	B3P5-VH(LF)(SN)	VHR-5N	Reel: SVH-21T-P1.1 Bulk: BVH-21T-P1.1	YC-160R
Output side	S8EX-N015□□□□ S8EX-N030□□□□ S8EX-BP050□□□□	CN51	B4P-VH(LF)(SN)	VHR-4N		YC-160R
Output side	S8EX-N015□□□□-CN1	CN51	B4B-XH	XHP-4	Reel: SXH-001T-P0.6 Bulk: BXH-001T-P0.6	YC-111R
Output side	S8EX-□P100□□□□	CN51	B8P-VH(LF)(SN)	VHR-8N	Reel: SVH-21T-P1.1 Bulk: BVH-21T-P1.1	YC-160R
Output side	S8EX-□P150□□□□	CN51	B6P-VH(LF)(SN)	VHR-6N		YC-160R
Output side		CN52	B7P-VH(LF)(SN)	VHR-7N		YC-160R
Output side	S8EX-BP240□□□□	CN51	B8P-VH(LF)(SN)	VHR-8N		YC-160R
Manufacturer			J.S.T. Mfg. Co., Ltd.			

Note: The female connectors that are required for wiring are not provided with the Power Supply.

Special Harnesses for S8EX-Series
Applicable Models and Harness Models

Applicable models (S8EX-Series)						Connected to		Model number	Qty
15 W	30 W	50 W	100 W	150 W	240 W	Input side and output side	Output (+, -)		
OK	OK	OK	OK	OK	OK	Input side	Output (±), common	S82Y-EX01HI-01	1
OK	OK	OK				Output side		S82Y-EX01HO-01	
OK*						Output side		S82Y-EX02HO-01	
			OK		OK	Output side		S82Y-EX03HO-01	
				OK		Output side		Output side +	
				OK		Output side	Output side -	S82Y-EX05HO-01	
OK	OK	OK	OK	OK	OK	Input side	Output (±), common	S82Y-EX01HI-10	10
OK	OK	OK				Output side		S82Y-EX01HO-10	
OK*						Output side		S82Y-EX02HO-10	
			OK		OK	Output side		S82Y-EX03HO-10	
				OK		Output side		Output side +	
				OK		Output side	Output side -	S82Y-EX05HO-10	

* Application is possible only to the S8EX-CN1.

Harness Specifications

Model number	Connector structure	Shape	Applicable wires				
			Pin	Wire	AWG	Color	Length: L (mm)
S82Y-EX01HI-□□	Housing Model: VHR-5N Manufacturer: J.S.T. Mfg. Co., Ltd. Pins Model: SVH-21T-P1.1 Manufacturer: J.S.T. Mfg. Co., Ltd.		1	UL1015	18	Black	500
			2	NC			
			3	UL1015	18	White	500
			4	NC			
			5	UL1015	18	Green	500
S82Y-EX01HO-□□	Housing Model: VHR-4N Manufacturer: J.S.T. Mfg. Co., Ltd. Pins Model: SVH-21T-P1.1 Manufacturer: J.S.T. Mfg. Co., Ltd.		1	UL1015	18	Black	500
			2	UL1015	18	Black	500
			3	UL1015	18	Red	500
			4	UL1015	18	Red	500
S82Y-EX02HO-□□	Housing Model: XHP-4 Manufacturer: J.S.T. Mfg. Co., Ltd. Pins Model: SXH-001T-P0.6 Manufacturer: J.S.T. Mfg. Co., Ltd.		1	UL1007	22	Black	500
			2	UL1007	22	Black	500
			3	UL1007	22	Red	500
			4	UL1007	22	Red	500
S82Y-EX03HO-□□	Housing Model: VHR-8N Manufacturer: J.S.T. Mfg. Co., Ltd. Pins Model: SVH-21T-P1.1 Manufacturer: J.S.T. Mfg. Co., Ltd.		1	UL1015	18	Black	500
			2	UL1015	18	Black	500
			3	UL1015	18	Black	500
			4	UL1015	18	Black	500
			5	UL1015	18	Red	500
			6	UL1015	18	Red	500
			7	UL1015	18	Red	500
			8	UL1015	18	Red	500
S82Y-EX04HO-□□	Housing Model: VHR-6N Manufacturer: J.S.T. Mfg. Co., Ltd. Pins Model: SVH-21T-P1.1 Manufacturer: J.S.T. Mfg. Co., Ltd.		1	UL1015	18	Red	500
			2	UL1015	18	Red	500
			3	UL1015	18	Red	500
			4	UL1015	18	Red	500
			5	UL1015	18	Red	500
			6	UL1015	18	Red	500
S82Y-EX05HO-□□	Housing Model: VHR-7N Manufacturer: J.S.T. Mfg. Co., Ltd. Pins Model: SVH-21T-P1.1 Manufacturer: J.S.T. Mfg. Co., Ltd.		1	UL1015	18	Black	500
			2	UL1015	18	Black	500
			3	UL1015	18	Black	500
			4	UL1015	18	Black	500
			5	UL1015	18	Black	500
			6	UL1015	18	Black	500
			7	UL1015	18	Black	500

Chassis cover option

Applicable models	Model number
15W	S82Y-EX030LC
30W	
50W	S82Y-EX050LC
100W	S82Y-EX100LC
150W	S82Y-EX150LC
240W	S82Y-EX240LC

Engineering Data

Derating Curves (Standard Mounting)

Open-frame Models and Models with Chassis (15 W)

Models with Chassis and Cover (15 W)

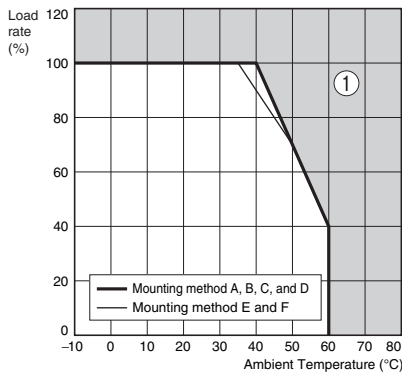
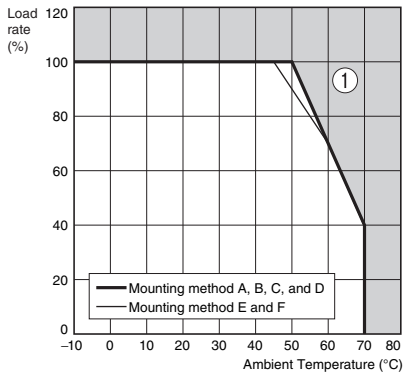

Open-frame Models and Models with Chassis (30 W)

Models with Chassis and Cover (30 W)

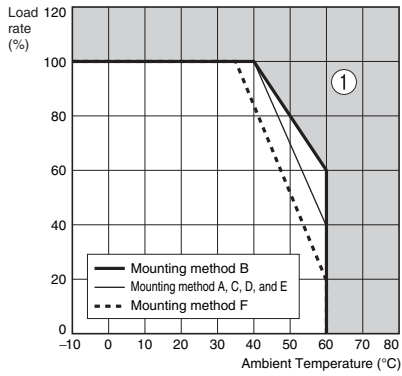
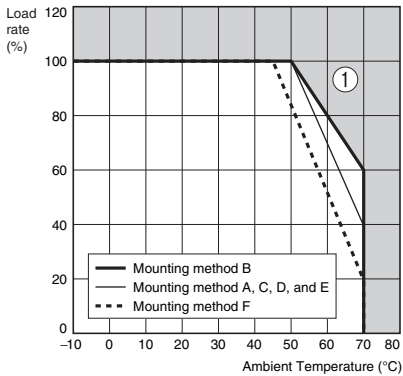

Open-frame Models (50W)

Models with Chassis (50 W)

Models with Chassis and Cover (50W)

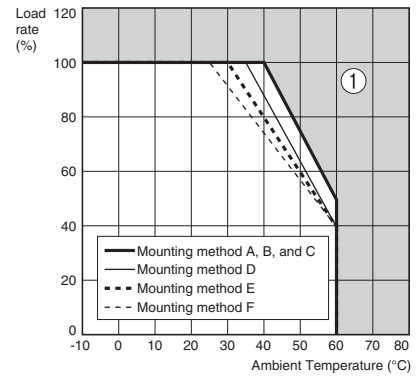
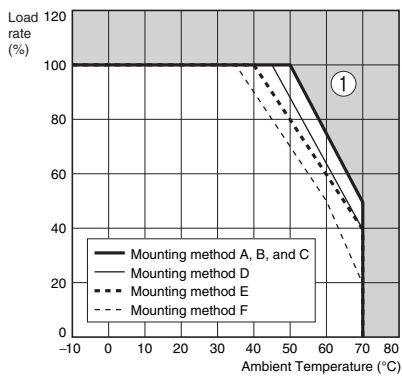
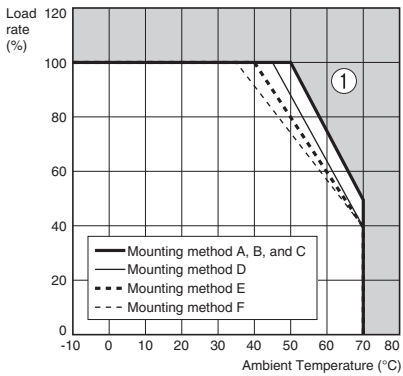

Open-frame Models (100W)

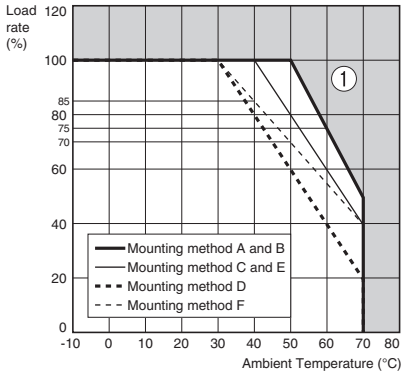

Models with Chassis (100 W)

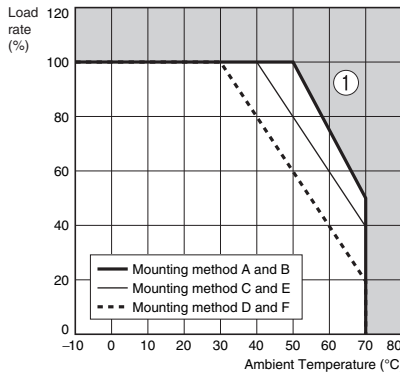

Models with Chassis and Cover (100W)

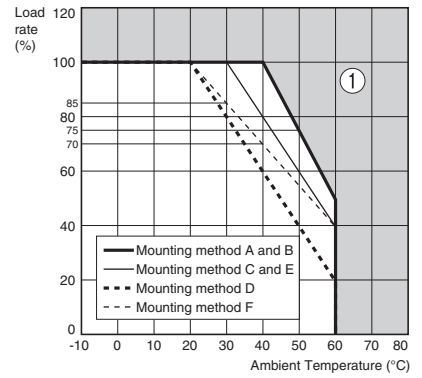

Open-frame Models (150 W)

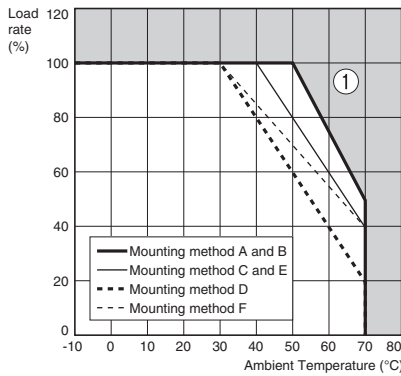

Models with Chassis (150 W)

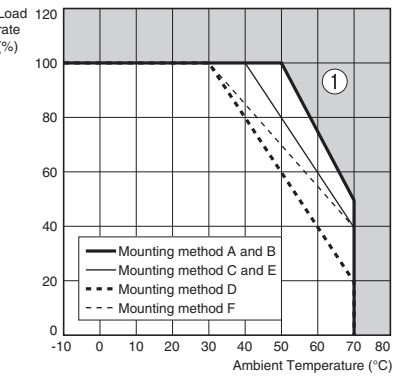

Models with Chassis and Cover (150 W)

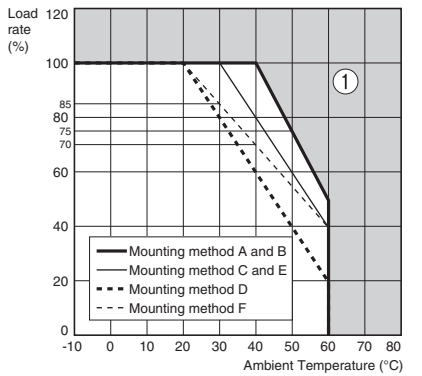

Open-frame Models and Models with Chassis (240 W)

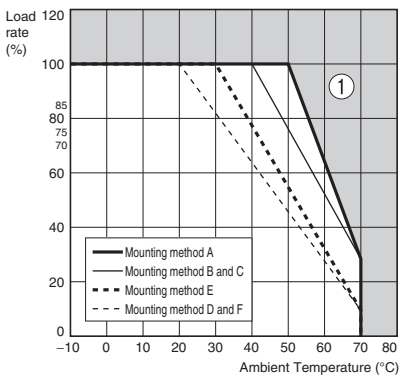

Models with Chassis and Cover (240W)

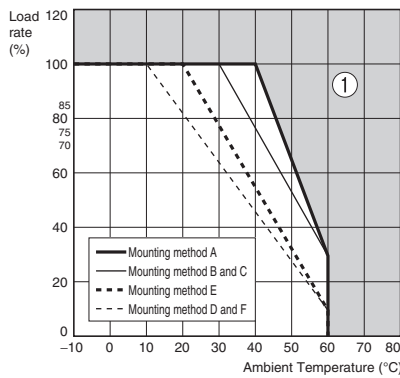

Mounting method A
(Standard mounting method)

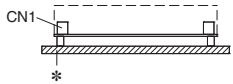

Mounting method B

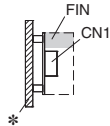

Mounting method C

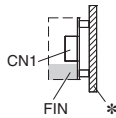

Mounting method D

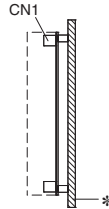

Mounting method E

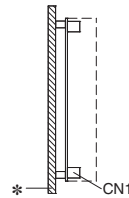

Mounting method F *

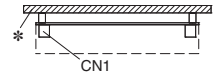

* UL certification has not been obtained for 240-W models.

- Note:**
1. Use a metal sheet* for the mounting surface.
 2. Refer to *Ambient Operating and Storage Environments* on page 22.
 3. A natural convection system is used for derating. Mount the Power Supply so that air convection will occur around it.

Input Voltage Derating Curve

For 50, 100, 150, and 240-W models, check the derating characteristics for the input voltage before using the Power Supply.

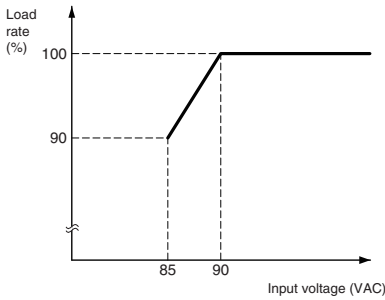

Overload Protection

The overload protection circuit will automatically reduce the output voltage for short circuits and overcurrents to protect the Power Supply from short-circuit currents and overcurrents.

Note: Refer to *Overload Protection* on page 24.

15 to 150-W Models

When the output current falls within the rated range, the overload protection function is automatically cleared.

Reference Graphs

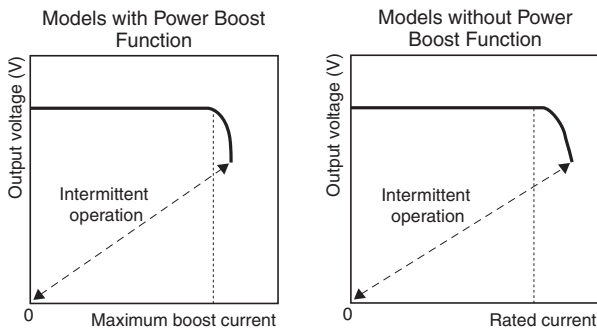

240-W Models

The output will be shut off if an output of 310 W or higher continues for approximately 5 seconds. To reset the protection, turn OFF the input power for three minutes or longer and then turn it back ON.

Reference Graph

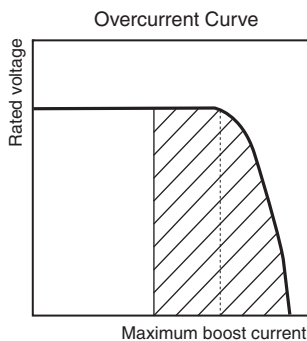

Overvoltage Protection

Consider the possibility of an overvoltage and design the system so that the load will not be subjected to an excessive voltage even if the feedback circuit in the power supply fails. When an excessive voltage that is approximately 130% of the rated voltage or more is output, the output voltage is shut OFF, preventing damage to the load due to overvoltage. Reset the input power by turning it OFF for at least three minutes and then turning it back ON again.

Reference Graph

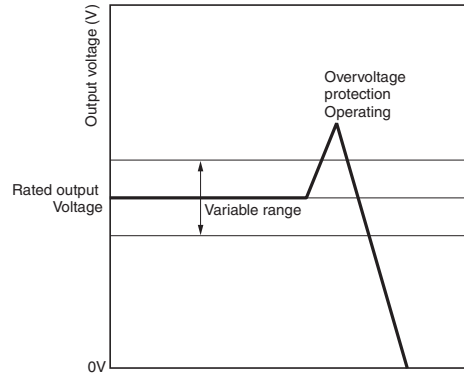

Note: Do not turn ON the power again until the cause of the overvoltage has been removed.

Inrush Current, Startup Time, Output Hold Time

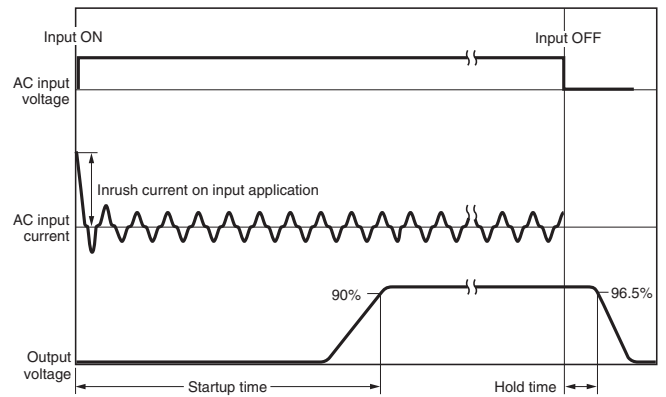

Note: A maximum startup time of 1,000 ms is required. Construct a system configuration that considers the startup time of other devices.

Remote Control Function (S8EX-□□□□□□□□□□-R only)

This function is to turn ON/OFF the output by applying a voltage to the remote control connector from a DC Power Supply (external power supply) other than this Power Supply.

Built-in resistance Ri (Ω)	Voltage between +RC and -RC (V)		Inrush current (mA)
	Output ON	Output OFF	
1kΩ	4.5 to 12.5	0 to 0.5	20 max.

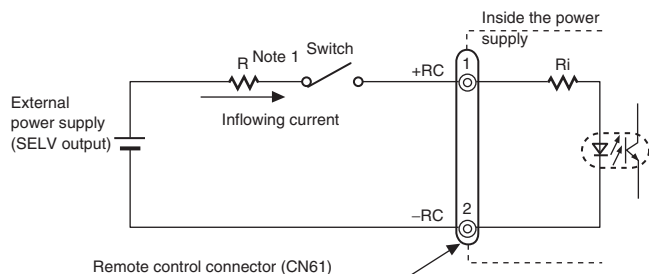

Usage example of the remote control

Connectors used:

	CN61	Applicable connector	Applicable contact
Model	B2B-XH-A	XHP-2	SXH-001T-P0.6 or SXH-002T-P0.6
Manufacturer	J.S.T. Mfg. Co., Ltd.		

Applicable crimp tool: YC-110R (J.S.T. Mfg. Co., Ltd.) or YRS-110 (J.S.T. Mfg. Co., Ltd.)

- Note: 1. When the external power supply is 4.5 to 12.5 V, the current limiting resistor R is not required. When it is 12.5 to 24.5 V, insert 1.5 kΩ as the current limiting resistor R.
- 2. Reverse connection of the connector may cause damage on the internal parts.
- 3. The +RC and -RC terminals are the secondary circuit of the power supply. Use an SELV output power supply for an external power supply. The remote control circuit is insulated from the secondary output of the power supply (functional insulation).

Undervoltage Alarm Function (240 W Only)

When a drop of output voltage is detected, the voltage is output to the outside by a transistor (DC LOW) (The output is OFF when the output voltage is low). The detection voltage is set approximately 80% (75 to 90%) of the rated output voltage.

- Note: 1. Transistor output: Open collector
30 VDC max., 50 mA max. ON: Residual voltage 2 V max., OFF: Leakage voltage 0.1 mA max.
- 2. The undervoltage alarm function monitors the voltage of the output terminal of the power supply unit. To check the accurate voltage condition, measure the voltage of the load side.
- 3. If the setting voltage is set to 90% or less of the rated voltage, the undervoltage alarm function may operate.

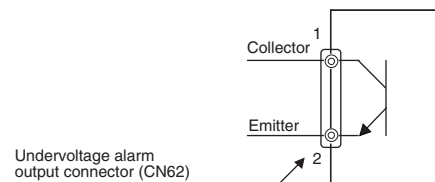

Output connector No. 2 (Emitter) is connected with the negative output.

Connectors used:

	CN62	Applicable connector	Applicable contact
Model	B2B-XH-A	XHP-2	SXH-001T-P0.6 or SXH-P002T-P0.6
Manufacturer	JST Mfg. Co., Ltd.		

Applicable crimp tool: YC-110R (JST Mfg. Co., Ltd.) or YRS-110 (JST Mfg. Co., Ltd.)

S8EX

Dimensions

(Unit: mm)

Power Supplies

Open-frame Model

S8EX-N015□ (15 W)

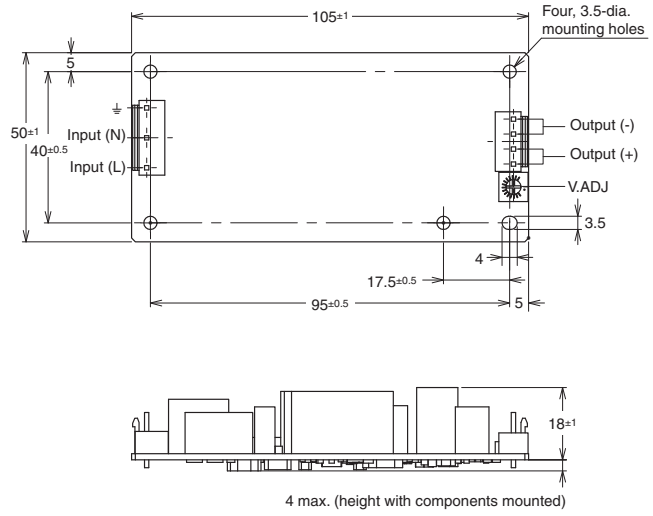
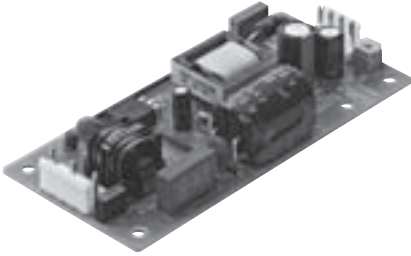

S8EX-N030□ (30 W)

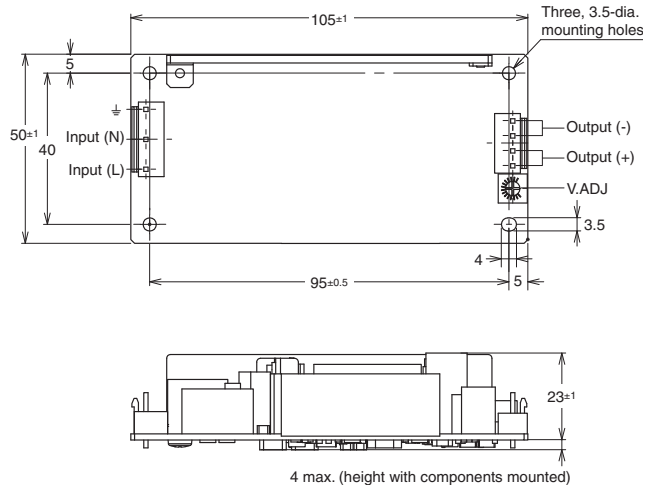
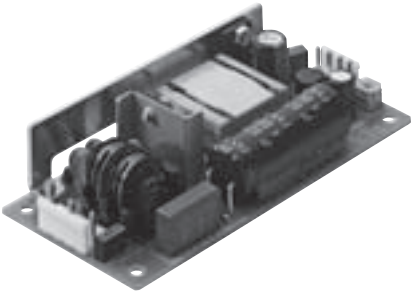

S8EX-BP050□□ (50 W)

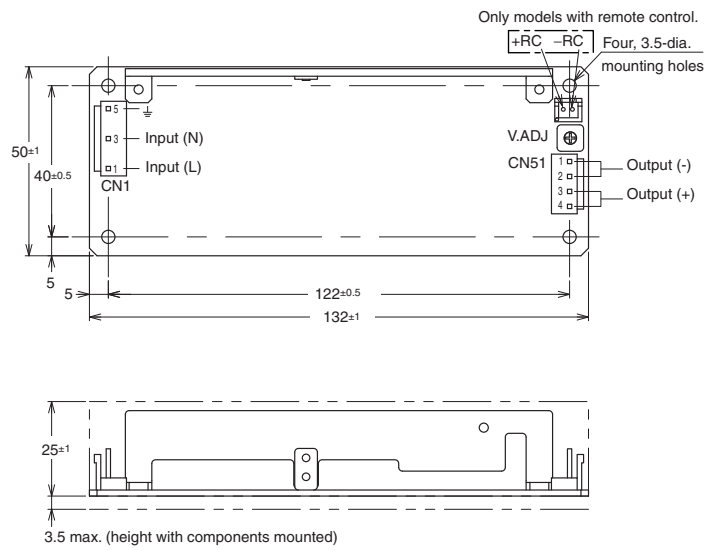
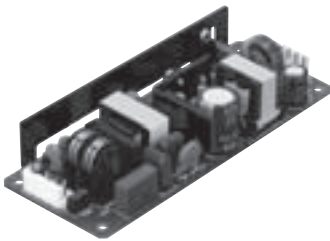

S8EX-□P100□□ (100 W)

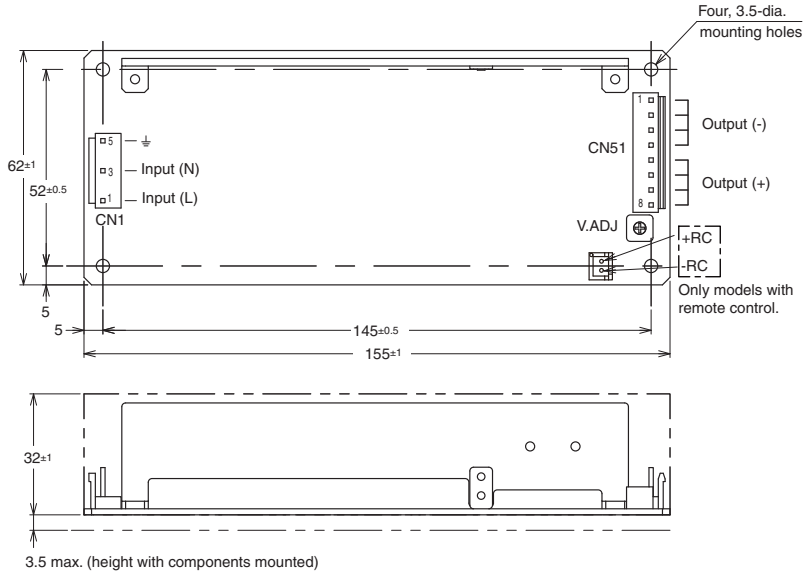
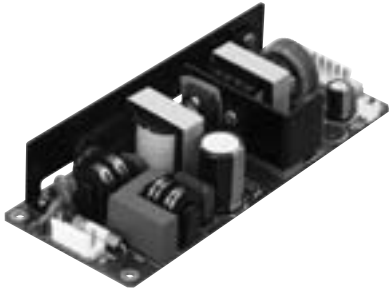

S8EX-□P150□□ (150 W)

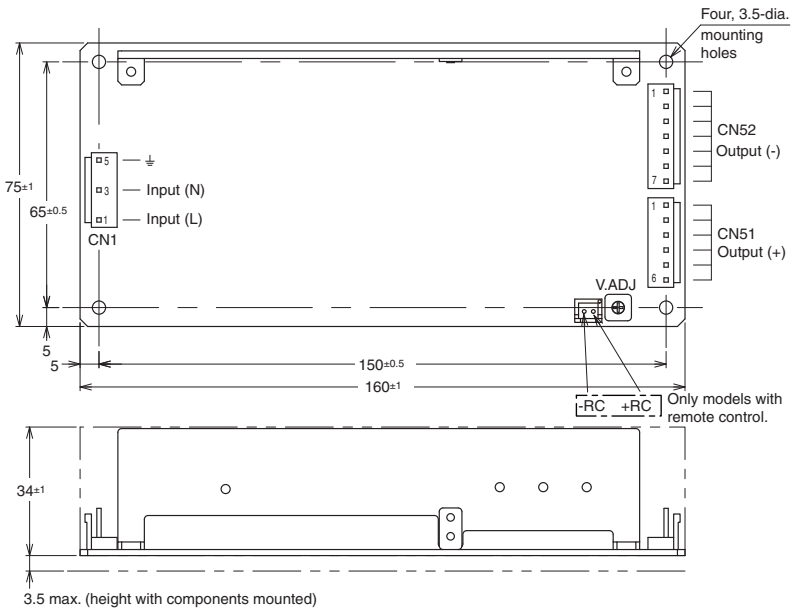
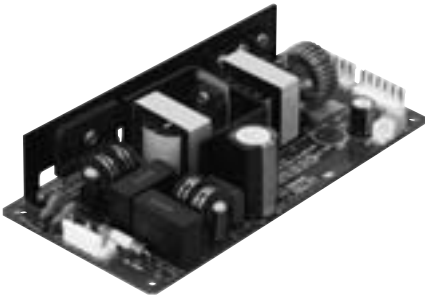

S8EX-□BP240□□ (240 W)

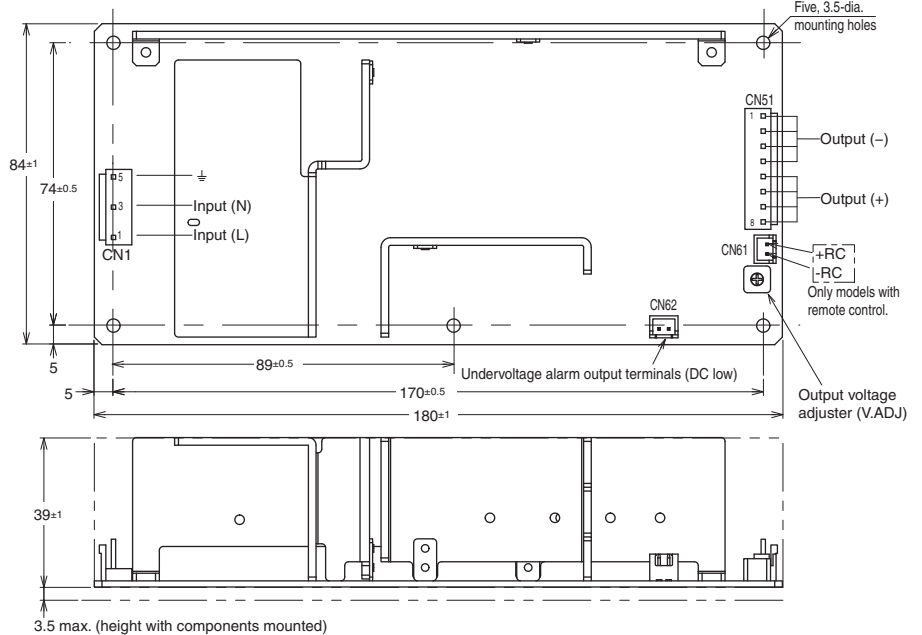
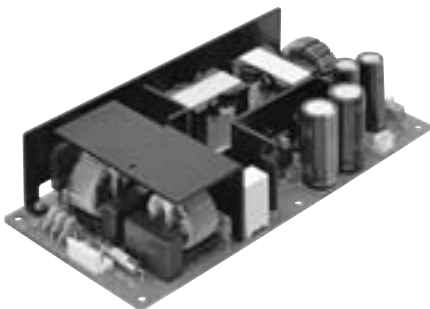

S8EX

With chassis and cover

S8EX-N015□□□ (15 W)

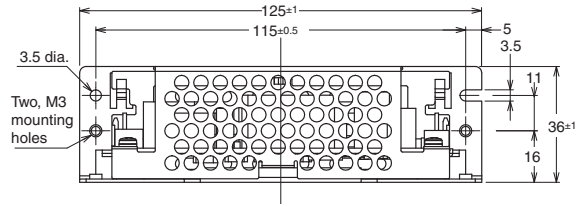
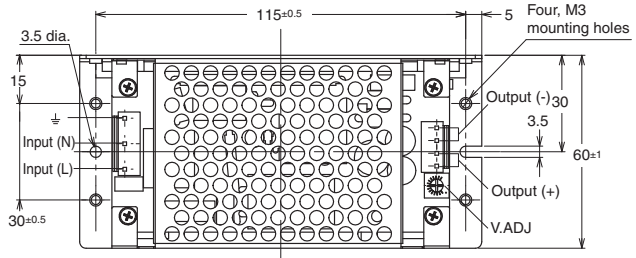
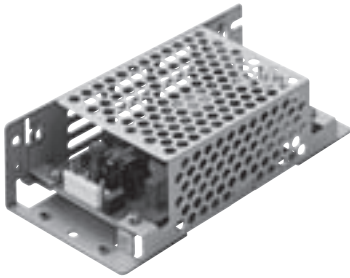

S8EX-N030□□□ (30 W)

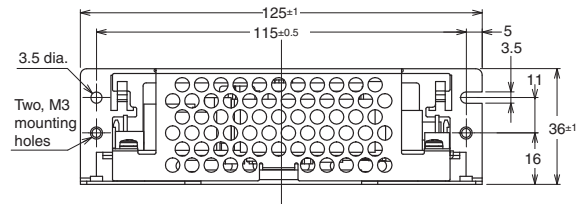
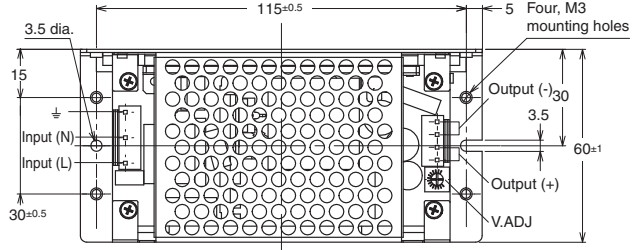
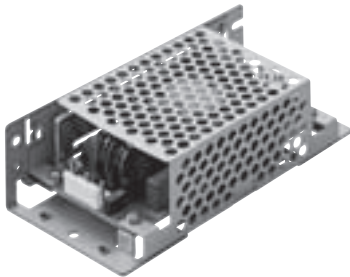

S8EX-BP050□□□ (50 W)

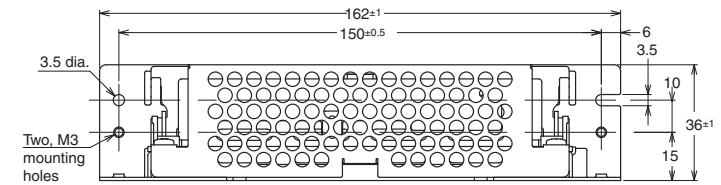
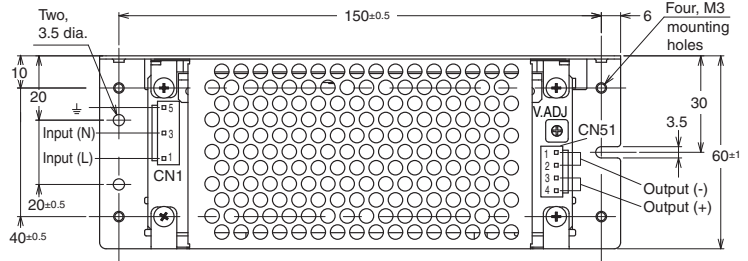
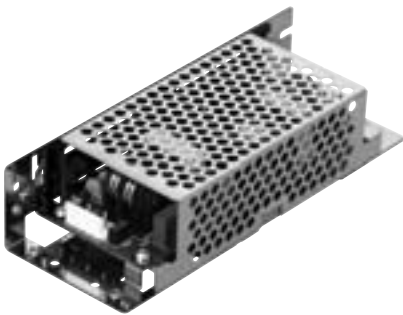

S8EX-□P100□L□ (100 W)

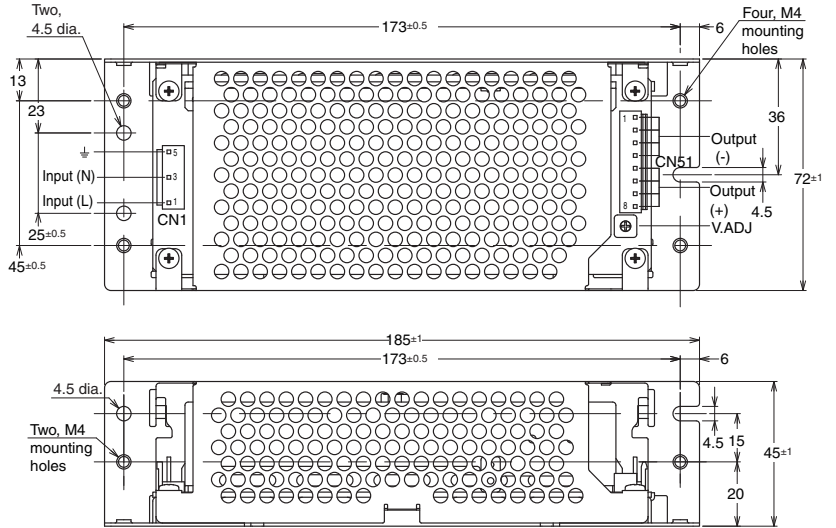
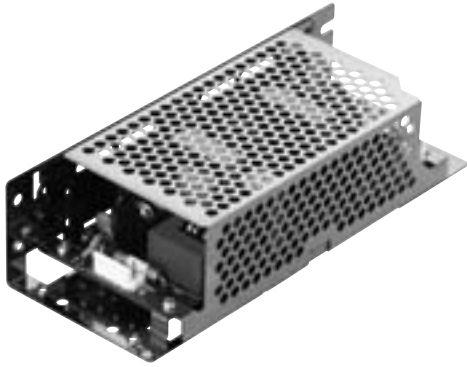

S8EX-□P150□L□ (150 W)

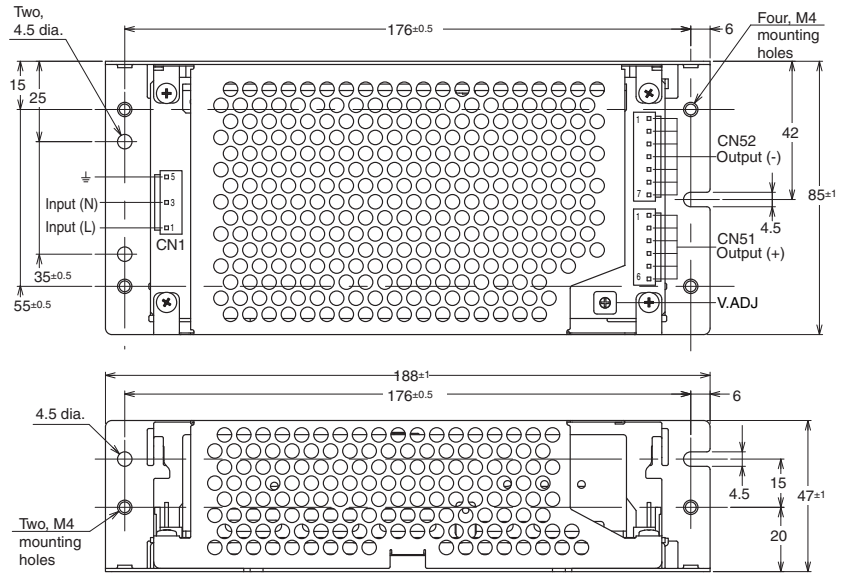
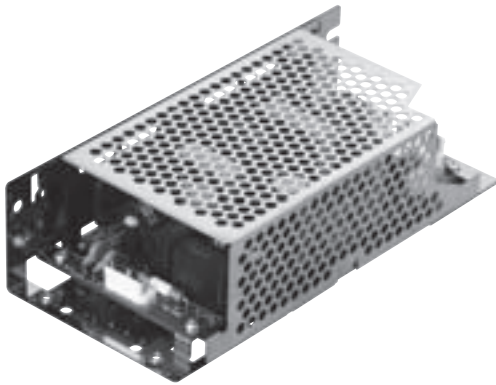

S8EX-BP240□L□ (240 W)

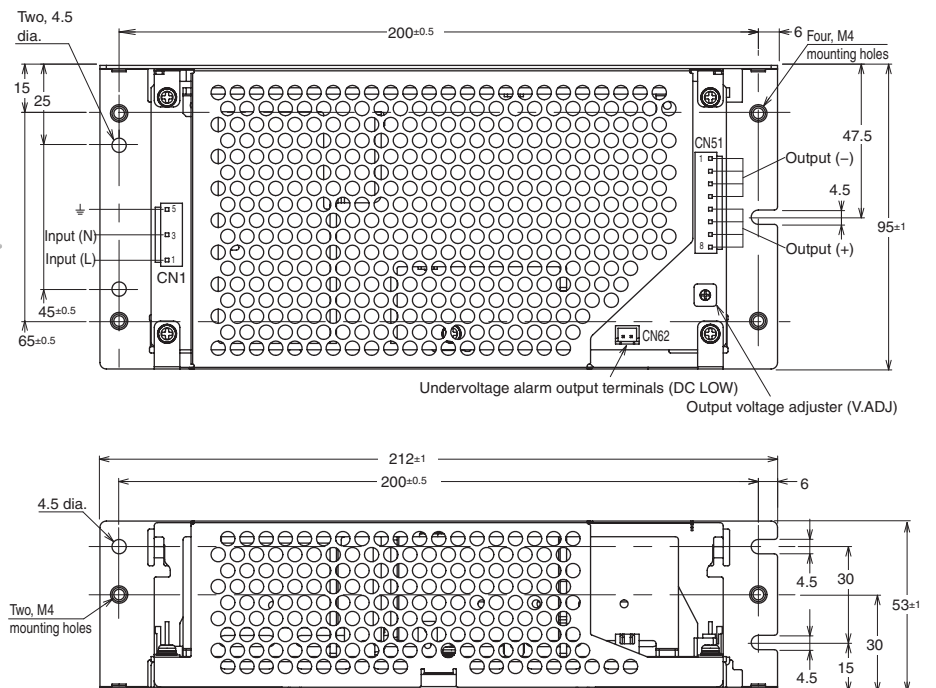
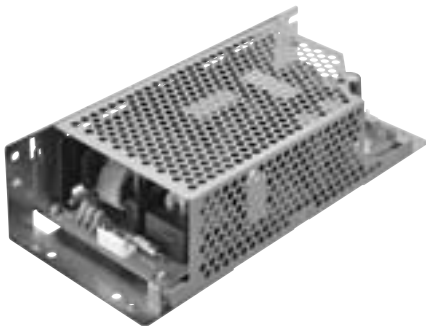





Safety Precautions

Refer to *Safety Precautions for All Power Supplies.*

Warning Indications

 CAUTION	Indicates a potentially hazardous situation which, if not avoided, may result in minor or moderate injury or in property damage.
Precautions for Safe Use	Supplementary comments on what to do or avoid doing, to use the product safely.
Precautions for Correct Use	Supplementary comments on what to do or avoid doing, to prevent failure to operate, malfunction or undesirable effect on product performance.

Meaning of Product Safety Symbols

	Used to warn of the risk of electric shock under specific conditions.
	Use to indicate prohibition when there is a risk of minor injury from electrical shock or other source if the product is disassembled.
	Used for general CAUTION, WARNING, or DANGER precautions for which there is no specified symbol. (This symbol is also used as the alerting symbol, but shall not be used in this meaning on the product.)
	Used to warn of the risk of minor injury caused by high temperatures.

 **CAUTION**

Minor electric shock, fire, or Product failure may occasionally occur. Do not disassemble, modify, or repair the Product to touch the interior of the Product.



Minor burns may occasionally occur. Do not touch the Product while power is being supplied or immediately after power is turned OFF.



Minor injury due to electric shock may occasionally occur. Do not touch the terminals while power is being supplied. Working voltage can be 370V max. inside. This voltage can be also available 30s after the switch off.



Minor electric shock, fire, or Product failure may occasionally occur. Do not allow any pieces of metal or conductors or any clippings or cuttings resulting from installation work to enter the Product.



Precautions for Safe Use

Wiring

- Connect the ground completely. A protective earthing terminal stipulated in safety standards is used. Electric shock or malfunction may occur if the ground is not connected completely.
- Minor fire may possibly occur. Ensure that input and output terminals are wired correctly.
- Be sure to remove the sheet covering the Product for machining before power-ON so that it does not interfere with heat dissipation.
- Use a wire diameter of at least 1.6 times the diameter that is required for the rated current to prevent heating and ignition of wire materials due to load abnormalities. Refer to the recommended allowable current, voltage drop, and other specifications from the manufacturer of the wires to select suitable wiring materials.
 - The current rating of each output terminal is 2 A for -CN1 models and it is 5 A for all other models. If more than the terminal current rating will flow, use two or more terminals together.
 - Use wiring materials with a UL recognized temperature of 60°C min. or 60°C/75°C min.
 - Use wiring materials with copper conductors.
- Refer to *Input and Output Connectors* on page 12 for the model numbers of the input and output connectors. Do not insert and remove any connector more than 20 times.

Installation Environment

- Do not use the Power Supply in locations subject to shocks or vibrations. In particular, install the Power Supply as far away as possible from contactors or other devices that are a vibration source.
- Install the Power Supply well away from any sources of strong, high-frequency noise and surge.

Ambient Operating and Storage Environments

- Store the Power Supply at a temperature of -25 to 75°C and a humidity of 25% to 90%.
- The Internal parts may occasionally deteriorate or be damaged. Do not use the Power Supply beyond the operating temperature range for the installation direction.
- The Internal parts may occasionally deteriorate or be damaged. Do not use the Power Supply outside the derating range (i.e., the area shown by shading ① in the derating curve diagram.)
- Use the Power Supply at a humidity of 25% to 85%.
- Do not use the Power Supply in locations subject to direct sunlight.
- Do not use locations where liquids, foreign matter, or corrosive gases may enter the interior of the Product.

Precautions for Correct Use

Mounting

Mounting interval

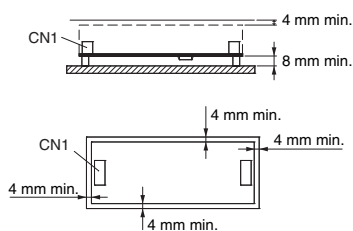

Mounting hole position

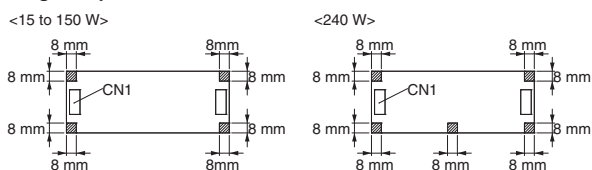

- Take adequate measures to ensure proper heat dissipation to increase the long-term reliability of the Product.
- The S8EX-series are designed to radiate heat by means of natural air-flow. Be sure to allow convection in the atmosphere around devices when mounting.
- The shaded portions indicate the allowable range of the metal mounting parts.
- When mounting, use the mounting holes in the board and spacers to mount at least 8 mm off the board. This a clearance of 4 mm space is necessary to satisfy the insulation and withstand voltage standards.
- Metal plate is strongly recommended as the mounting panel.

Note: 1. Do not subject the board to stress such as twisting, bending, or shock. This may cause failure or deterioration.

2. During assembly, do not subject the lead feet or surface mounted parts to stress. This may cause failure or deterioration.

- Do not allow cuttings to enter the Power Supply during installation.
- Depending on how the Power Supply is mounted, the heat dissipating capacity may be reduced and cause deterioration to or damage internal components.
- The internal parts may occasionally deteriorate and be broken due to adverse heat radiation. Do not loosen the screws on the Power Supply.

Output Voltage Adjuster (V.ADJ)

Default Setting: Set at the rated voltage

Adjustment Range : The output voltage can be adjusted to $\pm 10\%$ of the rated voltage with the voltage output adjuster (V.ADJ) on the front panel. Turning clockwise increases the output voltage, and turning counterclockwise decreases the output voltage.

- The output voltage adjuster (V.ADJ) may possibly be damaged if it is turned with unnecessary force. Do not turn the adjuster with excessive force.
- After completing output voltage adjustment, be sure that the output capacity or output current does not exceed the rated output capacity or rated output current.
- Adjusting the output voltage adjuster (V.ADJ) may cause the output voltage to exceed the voltage range. When adjusting the output voltage, check the output voltage of the Power Supply and be sure that the load is not destroyed.

Series Operation

Two power supplies can be connected in series. The (\pm) voltage output can be accomplished with two Power Supplies.

Series Operation Correct

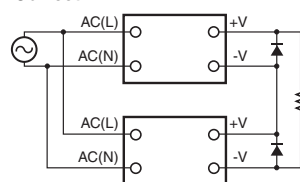

Output Voltage (\pm) Correct

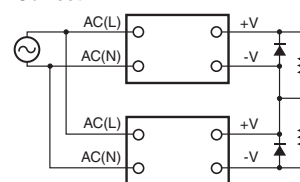

Note: 1. If the load is short-circuited, a reverse voltage will be generated inside the Power Supply. If this occurs the Power Supply may possibly deteriorate or be damaged. Always connect a diode as shown in the figure. Select a diode having the following ratings.

Type	Schottky Barrier diode
Dielectric strength (V_{RRM})	Twice the rated output voltage or above
Forward current (I_F)	Twice the rated output current or above

2. Although Products having different specifications can be connected in series, the current flowing through the load must not exceed the smaller rated output current.

Parallel Operation

The Product is not designed for parallel operation.

Parallel Operation Incorrect

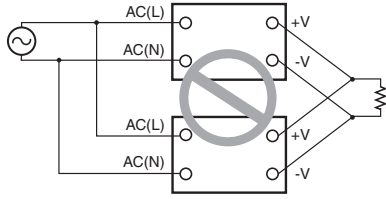

However, the following backup operation is possible. (External diodes are required.)

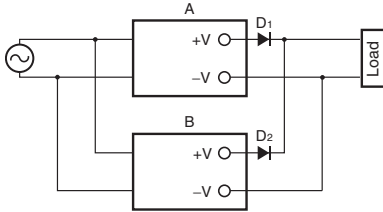

Use the same model for Power Supplies A and B.

- Type: Schottky barrier diode
- Dielectric strength (VRRM): Rated output voltage of the Power Supply or higher
- Forward current (IF): Twice the rated output current of the Power Supply or higher

- Set the output voltages of Power Supplies A and B higher to compensate for the decrease of the forward voltages (V_F) of diodes D1 and D2. Also, there will be a power loss equivalent to the output current (I_{out}) of the Power Supply multiplied by the forward voltage (V_F) of the diode. Therefore, cooling will be required to keep the temperature of the diodes lower than the catalog value.
- There will be a power loss caused by load power and diodes. Be sure not to exceed the rated power (rated output voltage times rated output current) of each Power Supply.

Overload Protection

- Internal parts may possibly deteriorate or be damaged if a shortcircuited, overload or boost load state continues during operation.
- Internal parts may possibly deteriorate or be damaged if the Power Supply is used for applications with frequent inrush current or overloading at the load end. Do not use the Power Supply for such applications.

Charging a Battery

When connecting a battery at the load, connect an overcurrent limiting circuit and overvoltage protection circuit.

In Case There Is No Output Voltage

The possible cause for no output voltage may be that the overcurrent or overvoltage protection has operated. The internal protection may operate if a large amount of surge voltage such as a lightning surge occurs while turning ON the Power Supply.

In case there is no output voltage, please check the following points before contacting us:

- Checking overcurrent protected status:
Check whether the load is in overcurrent status or is short-circuited. Remove wires to load when checking.
- Checking overvoltage or internal protection:
Turn the power supply OFF once, and leave it OFF for at least 3 minutes for S8JX-P series. Then turn it ON again to see if this clears the condition.

Power Boost Function

- Do not allow the boost current to continue for more than the time given in the following figure (t_1). Also, do not let the duty cycle exceed the following conditions. This may damage the power supply.
- Lessen the load of the boost load current by adjusting the ambient temperature and the mounting orientation.
- Ensure that the average current of one cycle of the boost current does not exceed the specified value. Doing so may cause the Power Supply to fail.

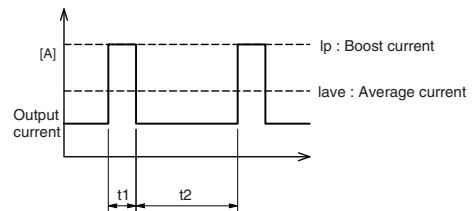

Models	Boost current conditions
S8EX-BP050□□□□ (50W) S8EX-BP100□□□□ (100W)	<ul style="list-style-type: none"> • $t_1 \leq 10s$ • $I_p \leq \text{Rated boost current}$ • $I_{ave} \leq \text{Rated current}$ • $\text{Duty} = \frac{t_1}{t_1+t_2} \times 100[\%] \leq 20\%$ (90 to 170 VAC) 30% (170 to 264 VAC)
S8EX-BP150□□□□ (150W)	<ul style="list-style-type: none"> • $t_1 \leq 10s$ • $I_p \leq \text{Rated boost current}$ • $I_{ave} \leq \text{Rated current} \times 70\%$ (90 to 170 VAC) Rated current (170 to 264 VAC) • $\text{Duty} = \frac{t_1}{t_1+t_2} \times 100[\%] \leq 10\%$ (90 to 170 VAC) 20% (170 to 264 VAC)
S8EX-BP240□□□□ (240W)	<ul style="list-style-type: none"> • $t_1 \leq 5s$ • $I_p \leq \text{Rated boost current}$ • $I_{ave} \leq \text{Rated current} \times 70\%$ (85 to 170 VAC) Rated current $\times 90\%$ (170 to 264 VAC) • $\text{Duty} = \frac{t_1}{t_1+t_2} \times 100[\%] \leq 20\%$

Note: Make sure that the boost current meets the above conditions. Consult with your OMRON representative if any other conditions are required.

Ripple Noise Voltage

The specified standard for the ripple voltage noise was measured with a measurement circuit that is based on JEITA standard RC-9131A.

