



Chipsmall Limited consists of a professional team with an average of over 10 year of expertise in the distribution of electronic components. Based in Hongkong, we have already established firm and mutual-benefit business relationships with customers from,Europe,America and south Asia,supplying obsolete and hard-to-find components to meet their specific needs.

With the principle of “Quality Parts,Customers Priority,Honest Operation,and Considerate Service”,our business mainly focus on the distribution of electronic components. Line cards we deal with include Microchip,ALPS,ROHM,Xilinx,Pulse,ON,Everlight and Freescale. Main products comprise IC,Modules,Potentiometer,IC Socket,Relay,Connector.Our parts cover such applications as commercial,industrial, and automotives areas.

We are looking forward to setting up business relationship with you and hope to provide you with the best service and solution. Let us make a better world for our industry!



Contact us

Tel: +86-755-8981 8866 Fax: +86-755-8427 6832

Email & Skype: info@chipsmall.com Web: www.chipsmall.com

Address: A1208, Overseas Decoration Building, #122 Zhenhua RD., Futian, Shenzhen, China





Package: SOT-86



Product Description

RFMD's SBA5086Z is a high performance InGaP/GaAs Heterojunction Bipolar Transistor MMIC Amplifier. A Darlington configuration designed with InGaP process technology provides broadband performance up to 5GHz with excellent thermal performance. The heterojunction increases breakdown voltage and minimizes leakage current between junctions. Cancellation of emitter junction non-linearities results in higher suppression of intermodulation products. Only a single positive supply voltage, DC-blocking capacitors, a bias resistor, and an optional RF choke are required for operation.

Optimum Technology Matching® Applied

- GaAs HBT
- GaAs MESFET
- InGaP HBT
- SiGe BiCMOS
- Si BiCMOS
- SiGe HBT
- GaAs pHEMT
- Si CMOS
- Si BJT
- GaN HEMT
- InP HBT
- RF MEMS
- LDMOS

Gain & Return Loss

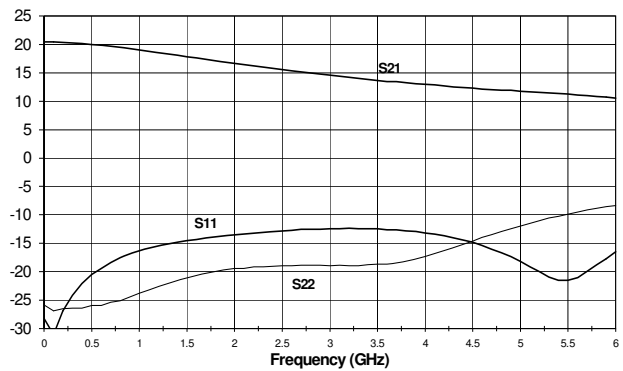

Features

- IP3=34.0dBm at 1950 MHz
- P_{OUT}=13.3dBm at -45dBc ACP IS-95 1950 MHz
- Robust 1000V ESD, Class 1C
- Operates From Single Supply
- Patented Thermal Design

Applications

- PA Driver Amplifier
- Cellular, PCS, GSM, UMTS
- IF Amplifier
- Wireless Data, Satellite Terminals

Parameter	Specification			Unit	Condition
	Min.	Typ.	Max.		
Small Signal Gain	17.5	19.0	20.5	dB	850MHz
	15.7	17.2	18.7	dB	1950MHz
Output Power at 1dB Compression	18	19.5		dBm	850MHz
		19.5		dBm	1950MHz
Output Third Order Intercept Point		36.9		dBm	850MHz
	32.0	34.0		dBm	1950MHz
Output Power		13.3		dBm	1950MHz, -45dBc ACP IS-95 9 Forward Channels
Bandwidth		5000		MHz	Return Loss > 10dB
Input Return Loss	11.0	13.0		dB	1950MHz
Output Return Loss	14.0	19.0		dB	1950MHz
Noise Figure		4.5	5.5	dB	1950MHz
Device Operating Voltage	4.7	4.9	5.3	V	
Device Operating Current	72	80	88	mA	
Thermal Resistance (junction to lead)		102		°C/W	

Test Conditions: V_S=8V, I_D=80mA Typ., OIP₃ Tone Spacing=1MHz, P_{OUT} per tone=0dBm, R_{BIAS}=39Ω, T_L=25°C, Z_S=Z_L=50Ω

Absolute Maximum Ratings

Parameter	Rating	Unit
Device Current (I_D)	130	mA
Device Voltage (V_D)	6	V
RF Input Power	+17	dBm
Junction Temp (T_J)	+150	°C
Operating Temp Range (T_L)	-40 to +85	°C
Storage Temp	+150	°C
Operating Dissipated Power	0.65	W

Operation of this device beyond any one of these limits may cause permanent damage. For reliable continuous operation, the device voltage and current must not exceed the maximum operating values specified in the table on page one.

Bias Conditions should also satisfy the following expression:

$$I_D V_D < (T_J - T_L) / R_{TH, J-L} \text{ and } T_L = T_{LEAD}$$



Caution! ESD sensitive device.

Exceeding any one or a combination of the Absolute Maximum Rating conditions may cause permanent damage to the device. Extended application of Absolute Maximum Rating conditions to the device may reduce device reliability. Specified typical performance or functional operation of the device under Absolute Maximum Rating conditions is not implied.

The information in this publication is believed to be accurate and reliable. However, no responsibility is assumed by RF Micro Devices, Inc. ("RFMD") for its use, nor for any infringement of patents, or other rights of third parties, resulting from its use. No license is granted by implication or otherwise under any patent or patent rights of RFMD. RFMD reserves the right to change component circuitry, recommended application circuitry and specifications at any time without prior notice.



RFMD Green: RoHS compliant per EU Directive 2002/95/EC, halogen free per IEC 61249-2-21, < 1000ppm each of antimony trioxide in polymeric materials and red phosphorus as a flame retardant, and <2% antimony in solder.

Typical Performance at Key Operating Frequencies

Parameter	Unit	100MHz	500MHz	850MHz	1950MHz	2400MHz	3500MHz
Small Signal Gain	dB	20.4	20.1	19.0	17.2	15.8	13.7
Output Third Order Intercept Point	dBm	36.4	36.2	36.9	34.0	33.7	30.8
Output Power at 1dB Compression	dBm	19.8	19.7	19.5	19.5	18.7	17.1
Input Return Loss	dB	31	20	17.5	13.0	12.9	12.4
Output Return Loss	dB	26	26	25	19.0	19	18.7
Reverse Isolation	dB	22.5	22.8	23	23	23	23
Noise Figure	dB	4.2	4.5	4.2	4.4	-	-

Test Conditions: $V_S = 8V$, $I_D = 80mA$ Typ., OIP_3 Tone Spacing = 1MHz, P_{OUT} per tone = 0dBm, $R_{BIAS} = 39\Omega$, $T_L = 25^\circ C$, $Z_S = Z_L = 50\Omega$

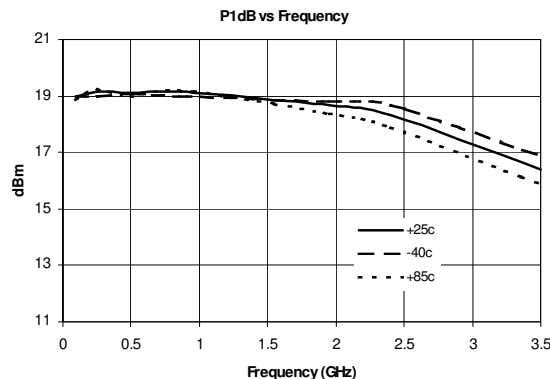
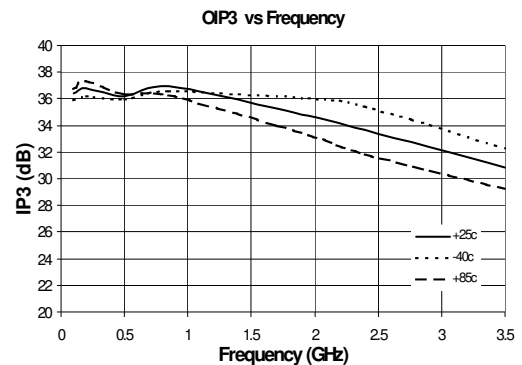
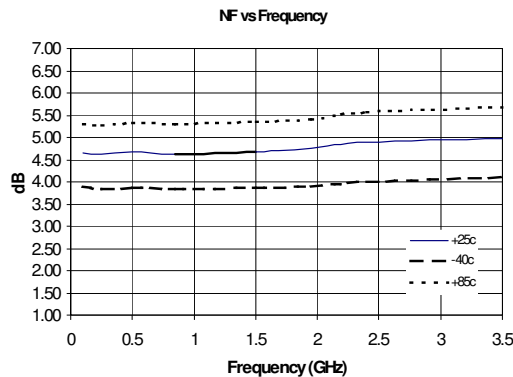

$|S_{11}|$ vs. Frequency

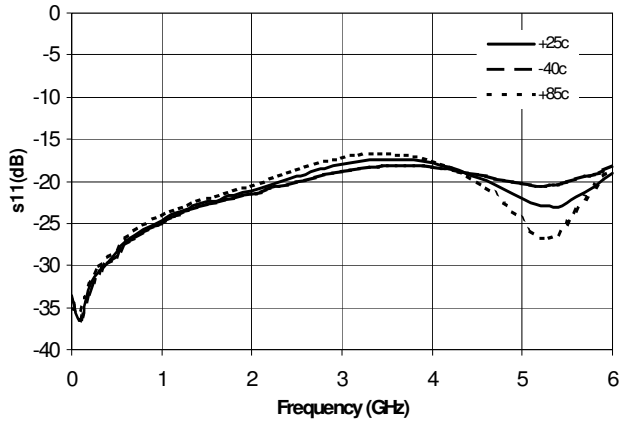

$|S_{21}|$ vs. Frequency

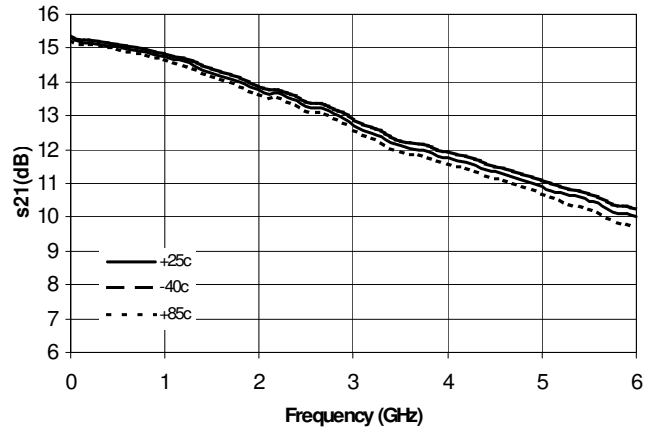

$|S_{12}|$ vs. Frequency

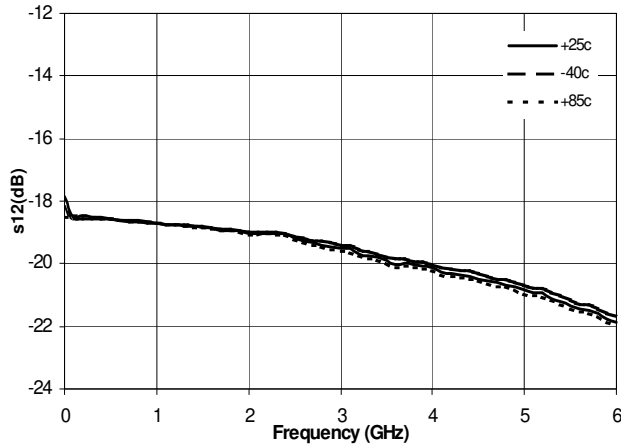

$|S_{22}|$ vs. Frequency

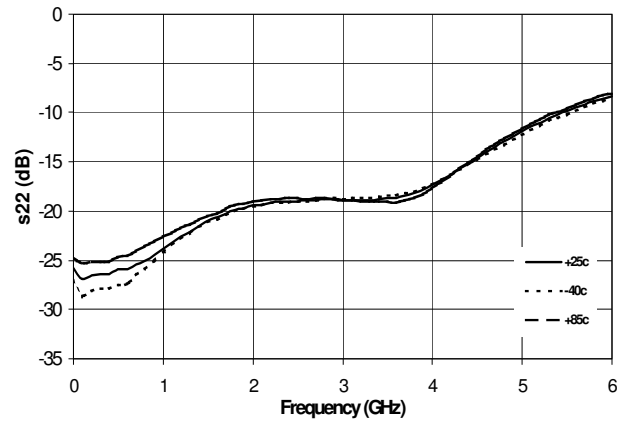

850MHz Adj. Chan. Pwr vs. Channel output Power

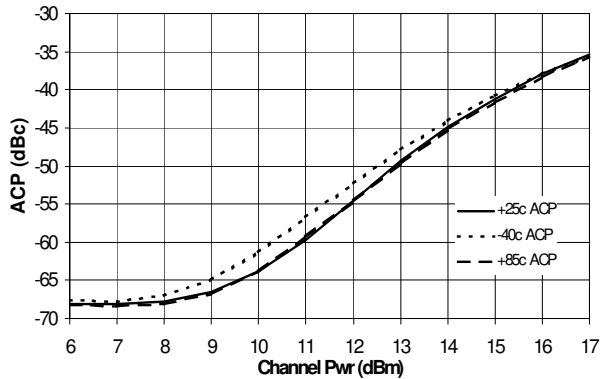

1950MHz Adj. Chan. Pwr Vs Channel Output Power

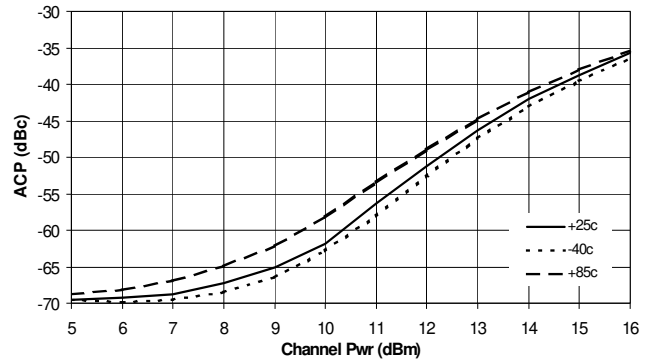

Basic Application Circuit

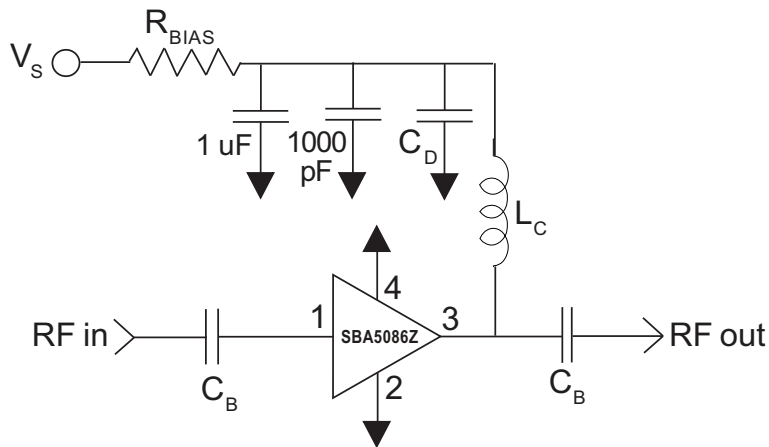

Evaluation Board Layout

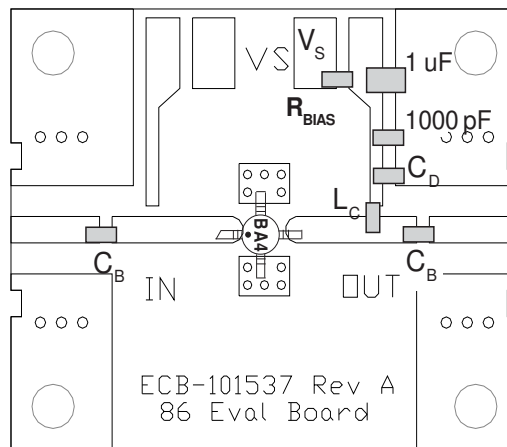

Mounting Instructions:

1. Use a large ground pad area under device pins 2 and 4 with many plated through-holes as shown.
2. We recommend 1 or 2 ounce copper. Measurements for this data sheet were made on a 31mil thick FR-4 board with 1 ounce copper on both sides.

Application Circuit Element Values

Reference Designator	500MHz	850MHz	1950MHz	2400MHz	3500MHz
C _B	220pF	100pF	68pF	56pF	39pF
C _D	100pF	68pF	22pF	22pF	15pF
L _C	68nH	33nH	22nH	18nH	15nH

Recommended Bias Resistor Values for I_D=80mA, R_{BIAS}=(V_S-V_D)/I_D

Supply Voltage (V _S)	7.5V	8V	10V	12V
R _{BIAS}	33Ω	39Ω	68Ω	91Ω

Note: R_{BIAS} provides DC bias stability over temperature.

Pin	Function	Description
1	RF IN	RF input pin. This pin requires the use of an external DC-blocking capacitor chosen for the frequency of operation.
2, 4	GND	Connection to ground. Use via holes for best performance to reduce lead inductance as close to ground leads as possible.
3	RF OUT/BIAS	RF output and bias pin. DC voltage is present on this pin, therefore a DC-blocking capacitor is necessary for proper operation.

PCB Pad Layout

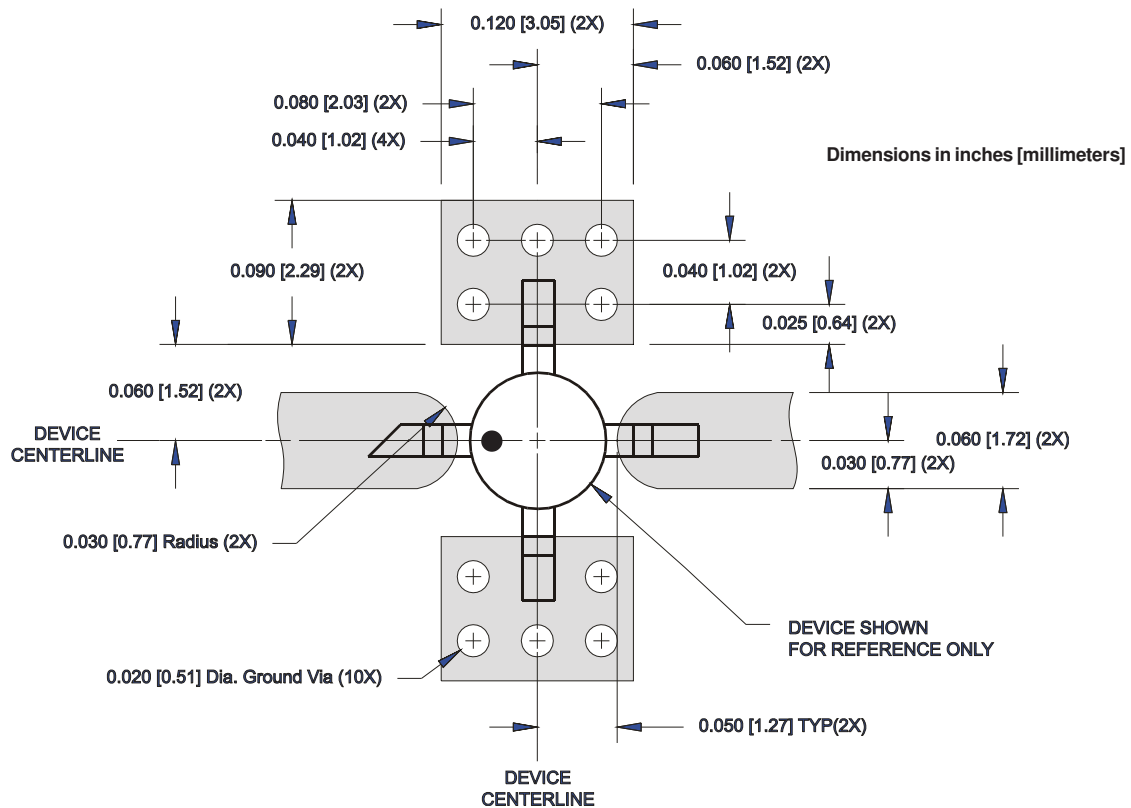

Package Drawing

Dimensions in inches (millimeters)
Refer to drawing posted at www.rfmd.com for tolerances.

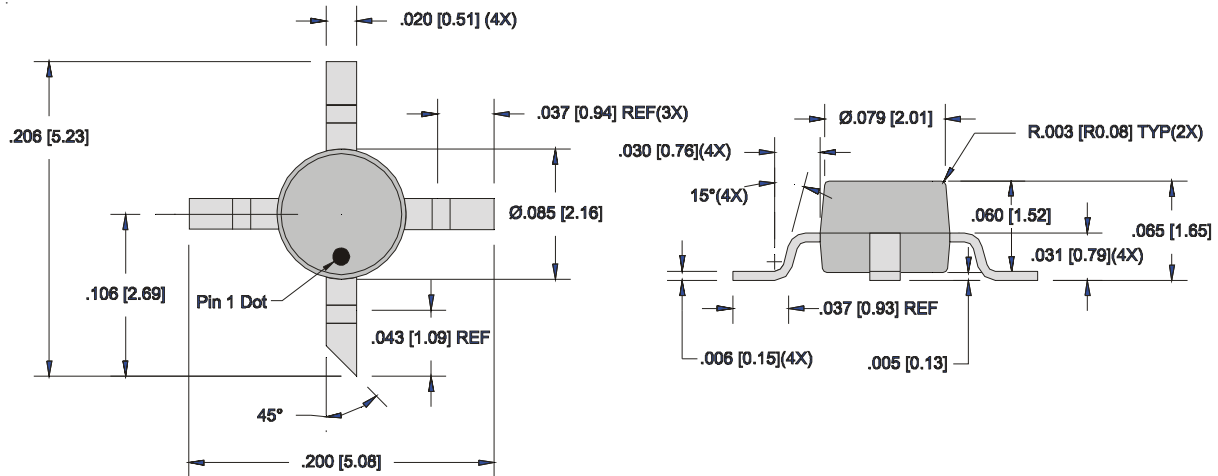

Part Identification

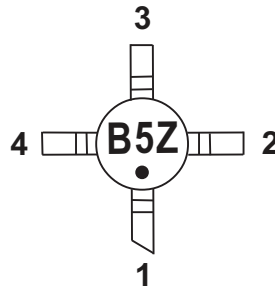

The part will be marked with a "B5Z" designator on the top surface of the package.

Ordering Information

Ordering Code	Description
SBA5086Z	7" Reel with 1000 pieces
SBA5086ZSQ	Sample bag with 25 pieces
SBA5086ZSR	7" Sample reel with 100 pieces
SBA5086ZPCK1	850MHz, 8V Operation PCBA with 5-piece sample bag