



Chipsmall Limited consists of a professional team with an average of over 10 year of expertise in the distribution of electronic components. Based in Hongkong, we have already established firm and mutual-benefit business relationships with customers from,Europe,America and south Asia,supplying obsolete and hard-to-find components to meet their specific needs.

With the principle of “Quality Parts,Customers Priority,Honest Operation,and Considerate Service”,our business mainly focus on the distribution of electronic components. Line cards we deal with include Microchip,ALPS,ROHM,Xilinx,Pulse,ON,Everlight and Freescale. Main products comprise IC,Modules,Potentiometer,IC Socket,Relay,Connector.Our parts cover such applications as commercial,industrial, and automotives areas.

We are looking forward to setting up business relationship with you and hope to provide you with the best service and solution. Let us make a better world for our industry!



## Contact us

Tel: +86-755-8981 8866 Fax: +86-755-8427 6832

Email & Skype: info@chipsmall.com Web: www.chipsmall.com

Address: A1208, Overseas Decoration Building, #122 Zhenhua RD., Futian, Shenzhen, China





# SBE818

## Schottky Barrier Diode

30V, 2A, Low  $I_R$ , Non-Monolithic Dual EMH8 Common Cathode

ON Semiconductor®

<http://onsemi.com>

### Applications

- High frequency rectification (switching regulators, converters, choppers)

### Features

- Composite type device with 2 low  $I_R$  SBD housed in one package, facilitating high density mounting
- Small switching noise
- Low forward voltage ( $I_F=2.0A$ ,  $V_F \text{ max}=0.62V$ )
- Low reverse current ( $V_R=15V$ ,  $I_R \text{ max}=7.5\mu A$ )
- Ultrasmall package permitting applied sets to be small and slim (Mounting height 0.75mm)

### Specifications

**Absolute Maximum Ratings** at  $T_a=25^\circ C$  (Value per element)

Parameter	Symbol	Conditions	Ratings	Unit
Repetitive Peak Reverse Voltage	$V_{RRM}$		30	V
Nonrepetitive Peak Reverse Surge Voltage	$V_{RSM}$		30	V
Average Output Current	$I_O$	When mounted on ceramic substrate, Rectangular wave 180°C	2.0	A
		When mounted on glass epoxy substrate	1.5	A
Surge Forward Current	$I_{FSM}$	50Hz sine wave, 1 cycle	20	A
Junction Temperature	$T_j$		-55 to +125	°C
Storage Temperature	$T_{stg}$		-55 to +125	°C

\*: The absolute maximum ratings and electrical characteristics refer to those between Terminal 1 and Terminal 7 (or 8), and between Terminal 3 and Terminal 5 (or 6)

Stresses exceeding Maximum Ratings may damage the device. Maximum Ratings are stress ratings only. Functional operation above the Recommended Operating Conditions is not implied. Extended exposure to stresses above the Recommended Operating Conditions may affect device reliability.

### Package Dimensions

unit : mm (typ)

7045-004

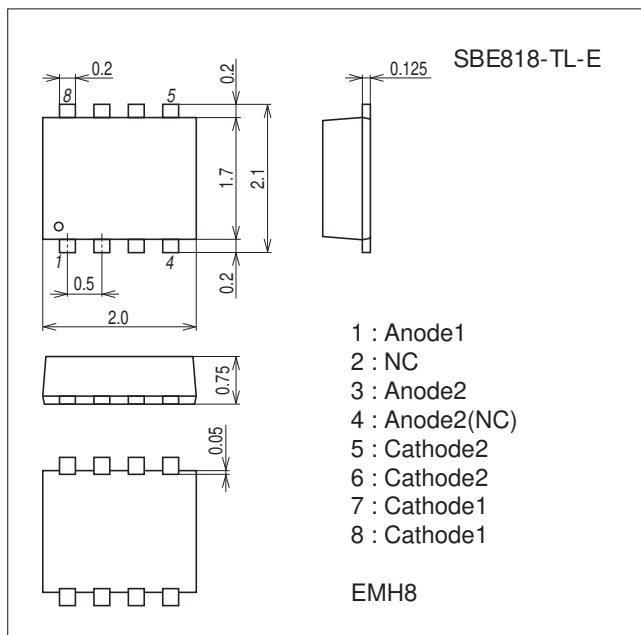

### Product & Package Information

- Package : EMH8
- JEITA, JEDEC : -
- Minimum Packing Quantity : 3,000 pcs./reel

### Packing Type : TL

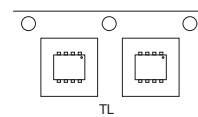

### Marking

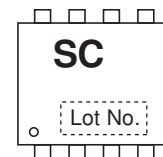

### Electrical Connection

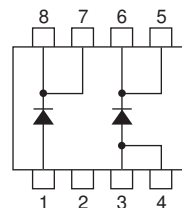

\*: Terminal 4 is used for the purposes such as test. Although it is connected to Anode 2, please handle it as NC Terminal.

# SBE818

## Electrical Characteristics at Ta=25°C (Value per element)

Parameter	Symbol	Conditions	Ratings			Unit
			min	typ	max	
Reverse Voltage	V <sub>R</sub>	I <sub>R</sub> =1mA	30			V
Forward Voltage	V <sub>F1</sub>	I <sub>F</sub> =1.0A		0.48	0.53	V
	V <sub>F2</sub>	I <sub>F</sub> =1.5A		0.53	0.58	V
	V <sub>F3</sub>	I <sub>F</sub> =2.0A		0.57	0.62	V
Reverse Current	I <sub>R</sub>	V <sub>R</sub> =15V			7.5	μA
Interterminal Capacitance	C	V <sub>R</sub> =10V, f=1MHz		30		pF
Reverse Recovery Time	t <sub>rr</sub>	I <sub>F</sub> =I <sub>R</sub> =100mA, See specified Test Circuit.			10	ns
Thermal Resistance	Rth(j-a)1	When mounted in Cu-foiled area of 0.96mm <sup>2</sup> ×0.03mm on glass epoxy substrate		100		°C / W
	Rth(j-a)2	When mounted on ceramic substrate (900mm <sup>2</sup> ×0.8mm)		65		°C / W

### t<sub>rr</sub> Test Circuit

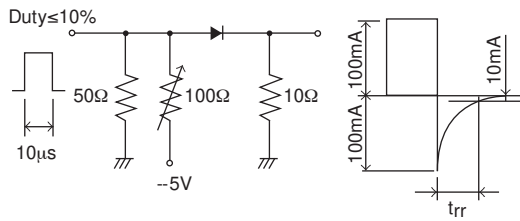

### Ordering Information

Device	Package	Shipping	memo
SBE818-TL-E	EMH8	3,000pcs./reel	Pb Free

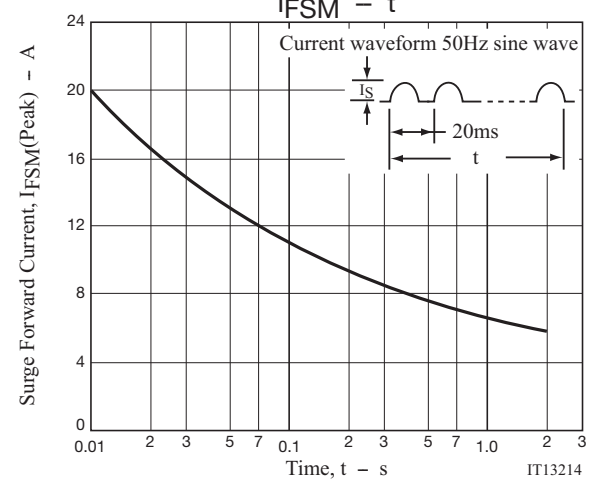
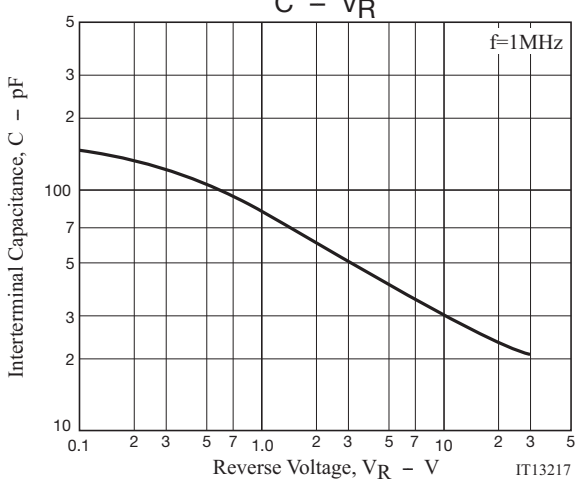
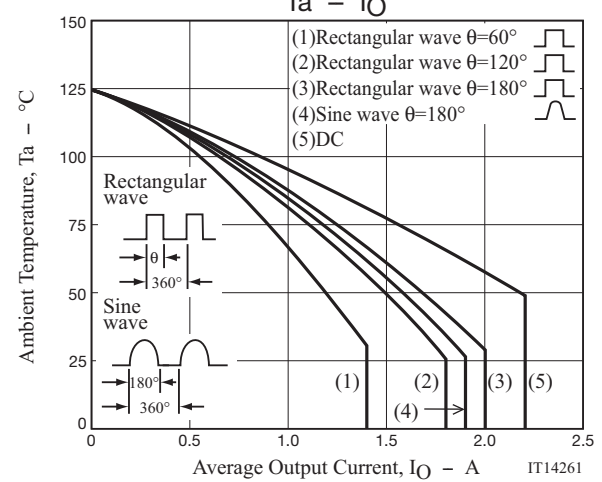
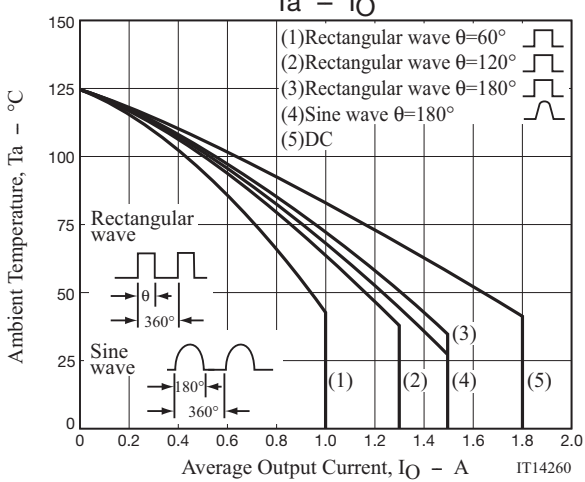
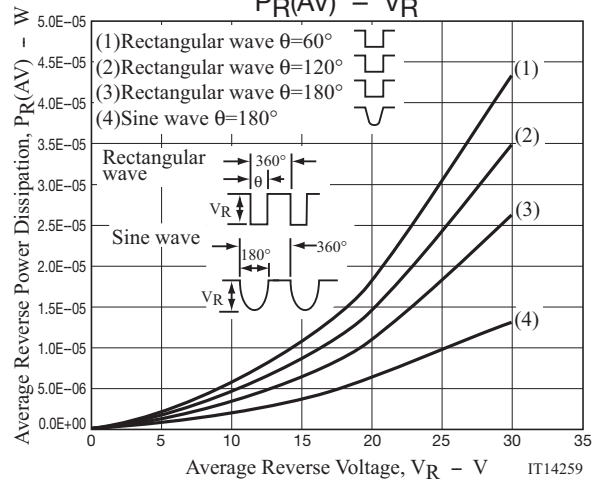
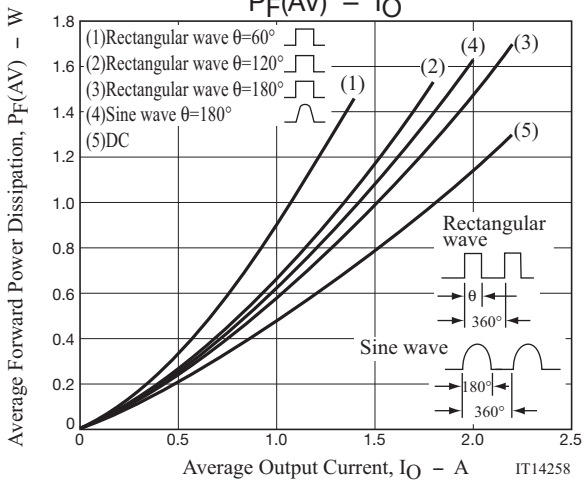
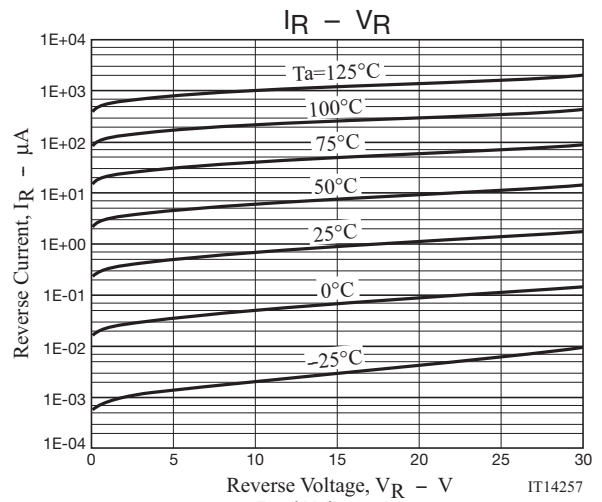
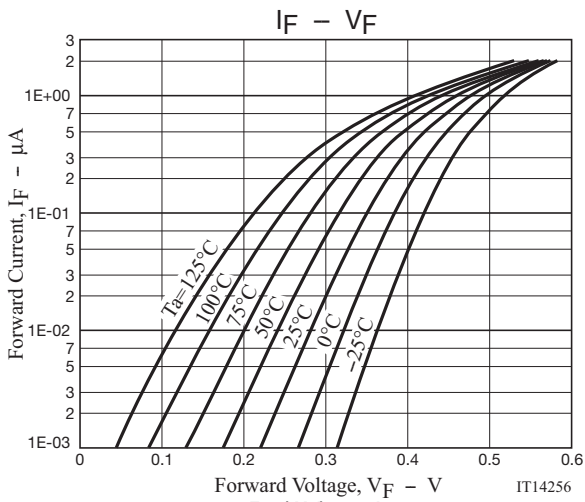

Embossed Taping Specification

SBE818-TL-E

1. Packing Format

Package Name	Carrier Tape Type	Maximum Number of devices contained (pcs)			Packing format	
		Reel	Inner box	Outer box	Inner BOX (C-1)	Outer BOX (A-7)
EMH8	MCP4	3,000	15,000	90,000	5 reels contained Dimensions:mm (external) 183×72×185	6 inner boxes contained Dimensions:mm (external) 440×195×210

Packing method

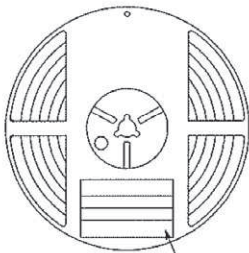

Type No. →  
 LOT No. →  
 Quantity →  
 Origin →

Reel label

Reel label, Inner box label (unit:mm)

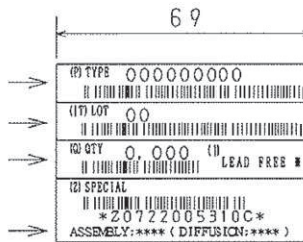

Outer box label

It is a label at the time of factory shipments. The form of a label may change in physical distribution process.

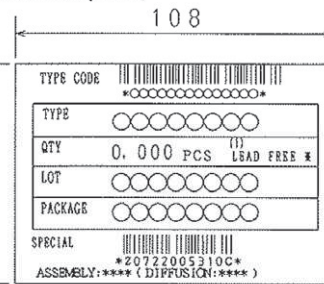

NOTE (1)

The LEAD FREE \* description shows that the surface treatment of the terminal is lead free.

Label	JEITA Phase
LEAD FREE 3	JEITA Phase 3A
LEAD FREE 4	JEITA Phase 3

2. Taping configuration

2-1. Carrier tape size (unit:mm)

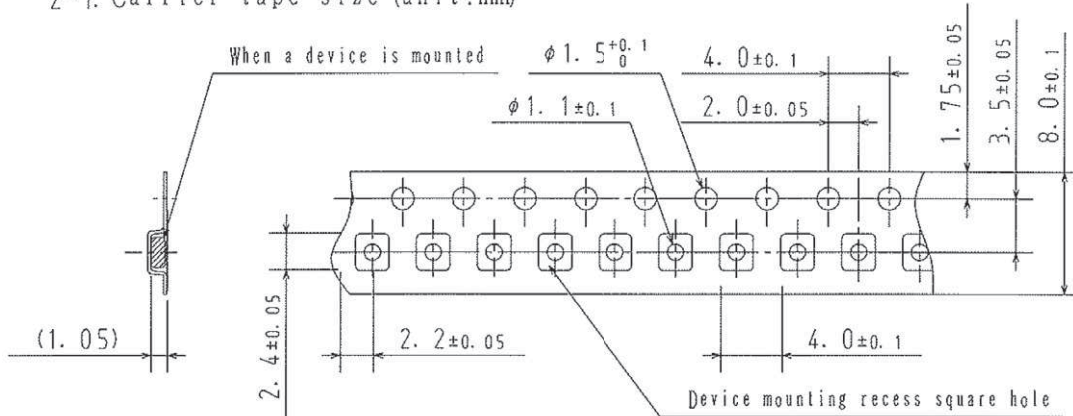

2-2. Device placement direction

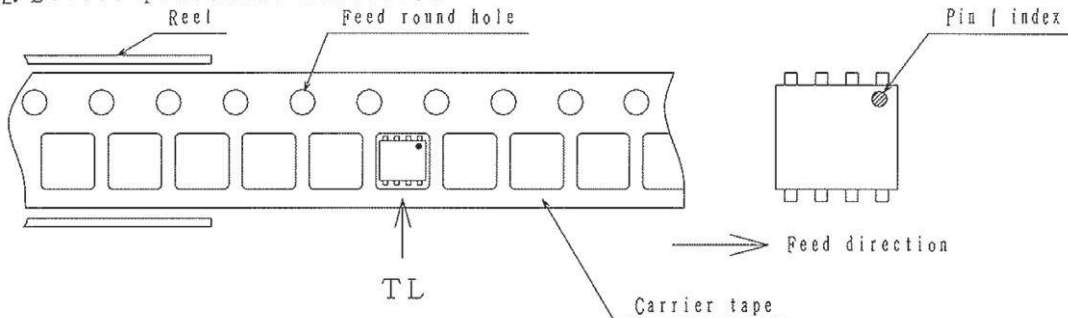

Those with pin | index on the feed hole side.....TL

# SBE818

## Outline Drawing

SBE818-TL-E

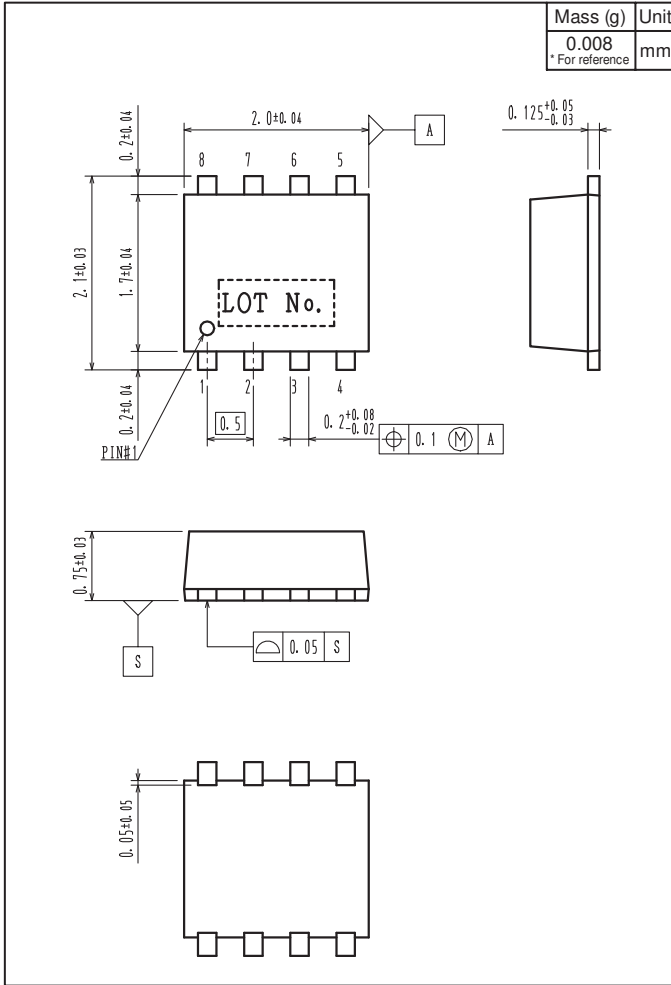

## Land Pattern Example

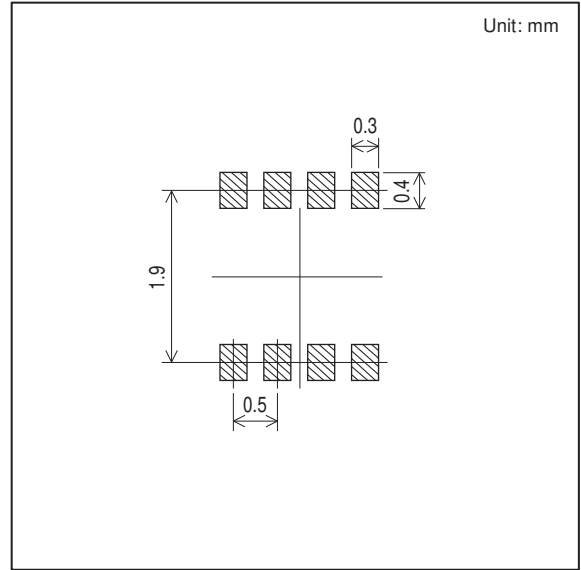

ON Semiconductor and the ON logo are registered trademarks of Semiconductor Components Industries, LLC (SCILLC). SCILLC owns the rights to a number of patents, trademarks, copyrights, trade secrets, and other intellectual property. A listing of SCILLC's product/patent coverage may be accessed at [www.onsemi.com/site/pdf/Patent-Marking.pdf](http://www.onsemi.com/site/pdf/Patent-Marking.pdf). SCILLC reserves the right to make changes without further notice to any products herein. SCILLC makes no warranty, representation or guarantee regarding the suitability of its products for any particular purpose, nor does SCILLC assume any liability arising out of the application or use of any product or circuit, and specifically disclaims any and all liability, including without limitation special, consequential or incidental damages. "Typical" parameters which may be provided in SCILLC data sheets and/or specifications can and do vary in different applications and actual performance may vary over time. All operating parameters, including "Typicals" must be validated for each customer application by customer's technical experts. SCILLC does not convey any license under its patent rights nor the rights of others. SCILLC products are not designed, intended, or authorized for use as components in systems intended for surgical implant into the body, or other applications intended to support or sustain life, or for any other application in which the failure of the SCILLC product could create a situation where personal injury or death may occur. Should Buyer purchase or use SCILLC products for any such unintended or unauthorized application, Buyer shall indemnify and hold SCILLC and its officers, employees, subsidiaries, affiliates, and distributors harmless against all claims, costs, damages, and expenses, and reasonable attorney fees arising out of, directly or indirectly, any claim of personal injury or death associated with such unintended or unauthorized use, even if such claim alleges that SCILLC was negligent regarding the design or manufacture of the part. SCILLC is an Equal Opportunity/Affirmative Action Employer. This literature is subject to all applicable copyright laws and is not for resale in any manner.