



Chipsmall Limited consists of a professional team with an average of over 10 year of expertise in the distribution of electronic components. Based in Hongkong, we have already established firm and mutual-benefit business relationships with customers from,Europe,America and south Asia,supplying obsolete and hard-to-find components to meet their specific needs.

With the principle of "Quality Parts,Customers Priority,Honest Operation,and Considerate Service",our business mainly focus on the distribution of electronic components. Line cards we deal with include Microchip,ALPS,ROHM,Xilinx,Pulse,ON,Everlight and Freescale. Main products comprise IC,Modules,Potentiometer,IC Socket,Relay,Connector.Our parts cover such applications as commercial,industrial, and automotives areas.

We are looking forward to setting up business relationship with you and hope to provide you with the best service and solution. Let us make a better world for our industry!



Contact us

Tel: +86-755-8981 8866 Fax: +86-755-8427 6832

Email & Skype: info@chipsmall.com Web: www.chipsmall.com

Address: A1208, Overseas Decoration Building, #122 Zhenhua RD., Futian, Shenzhen, China



SBM-120-UV

Surface Mount Series

Ultraviolet LED

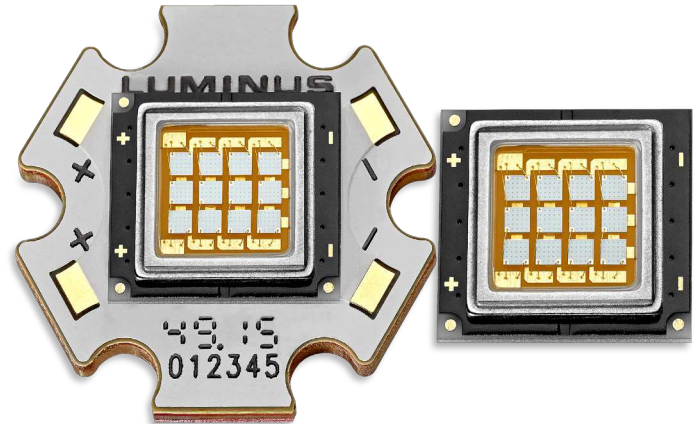

Table of Contents

General Considerations	2
Binning Structure	3
Part Numbering	4
Ordering Information	4
Optical and Electrical Characteristics	5
Angular Distribution	8
Typical Spectrum	8
Mechanical Dimensions	9
Thermal Resistance	10
Mechanical Dimensions SBM-120 Starboard	11
Solder Profile	12
Shipping Information	13
History of Changes	16

Features:

- Extremely high optical output from a compact UV LED emitter - over 20W/cm² output
- High thermal conductivity package - 0.28°C/W junction to case
- Surface Mount Array UV LED chipset with surface emitting area of 12 mm²
- Vertical chip UV LED technology for high power density and uniform emission
- Wide Range of UVA Wavelengths (365, 385, 395 and 405 nm)
- Unencapsulated die with low profile protective window facilitates optical coupling and maximizes irradiance versus working distance
- Electrically isolated thermal path
- Resilient series-parallel chip configuration for lower current operation up to 4.5A
- Environmentally friendly: RoHS and REACH compliant

Applications:

- Curing:
 - › Inks
 - › Coatings
 - › Adhesives
- Inspection
- Machine Vision
- Fiber-coupled illumination
- Scientific Instrumentation
- Entertainment Lighting / Black Lights

General Considerations

Environmental Considerations:

As a leading provider of solid-state lighting solutions, Luminus implements strict substance control policies to ensure all of its products are environmentally friendly. As all Luminus LEDs, the SBM-120-UV series are compliant with the Restriction of Hazardous Substances Directive (RoHS) and REACH directives from the European Community.

Product Testing:

Every SBM-120-UV LED is fully production tested to ensure it meets the high quality standards customers have come to expect from Luminus products. Devices are binned at 2.25A, 20 ms pulse condition at $T_j = 25^{\circ}\text{C}$. Current and temperature curves are provided in this document allowing users to predict the LED performance and characteristics under their own driving and thermal conditions.

Reliability:

Luminus SBM-120-UV LED series are required to pass a rigorous suite of environmental and mechanical stress tests, including mechanical shock, vibration, temperature cycling and humidity. These tests ensure that the devices deliver high performance and achieve reliable long term operation in the demanding environments. Please contact Luminus for further information.

SBM-120-UV Binning Structure

SBM-120-UV LEDs are specified for radiometric flux and peak wavelength at a drive current of 2.25 A and placed into one of the following Power Bins and Wavelength Bins:

Radiometric Flux Bins¹

Color	Flux Bin (F)	Minimum Flux (W)	Maximum Flux (W)
UV	H	8.0	9.1
	I	9.1	10.0
	J	10.0	11.0
	K	11.0	12.1
	L	12.1	13.3
	M	13.3	14.6
	N	14.6	16.1
	P	16.1	17.7
Q	17.7	19.5	

Note 1: Luminus maintains a +/- 6% tolerance on power measurements.

Wavelength Bins

Color	Wavelength Bin (WWW)	Minimum Wavelength (nm)	Maximum Wavelength (nm)
UV	365	365	370
	370	370	375
	380	380	385
	385	385	390
	390	390	395
	395	395	400
	400	400	405
	405	405	410

Ordering Information

Part Numbering Nomenclature

SBM <XX> W<tc> X34 <F###-##>

Product Family	Emitting Area	Color	Package Configuration	Bin Kit ^{1,2}
SBM = Ceramic Surface Mount Multi-Die Package	120 = 12 mm ²	UV = Ultraviolet	F34 = 10mm x 11mm Ceramic Surface Mount Package, 3x4 Array R34 = Starboard configuration	See page 3 for complete bin definition tables

Ordering Part Numbers

Wavelength Range (nm)	Radiometric Flux		Wavelength Bins	Package Configuration	Ordering Part Number ³
	Bin Kit Flux Code	Min. Flux (W)			
365-375	H	8.0	365, 370	F34	SBM-120-UV-F34-H365-22
	I	9.1	365, 370	F34	SBM-120-UV-F34-I365-22
380-390	L	12.1	380, 385	F34	SBM-120-UV-F34-L385-22
	M	13.3	380, 385	F34	SBM-120-UV-F34-M385-22
390-400	L	12.1	390, 395	F34	SBM-120-UV-F34-L395-22
	M	13.3	390, 395	F34	SBM-120-UV-M34-M395-22
400-410	K	11.0	400, 405	F34	SBM-120-UV-F34-K405-22
	L	12.1	400, 405	F34	SBM-120-UV-F34-L405-22

Note 1: A Bin Kit represents a group of individual flux or power bins that are shippable for a given ordering part number. Individual flux bins are not orderable.

Note 2: Flux Bin listed is minimum bin shipped - higher bins may be included at Luminus' discretion.

Note 3: For ordering package configuration R34, replace F34 with R34 in the Ordering Part Number.

Optical & Electrical Characteristics

Product Characteristics^{1,2}

UV						
Parameter	Symbol	Values ^{1,2}				Unit
Peak Wavelength Range	λ	365 - 375	380-390	390-400	400-410	nm
Test Current	I	2.25	2.25	2.25	2.25	A
Current Per Die	I_D	0.75	0.75	0.75	0.75	A
Peak Wavelength Typ.	λ_p	368	387	394	401	nm
Radiometric Flux ³	Φ_{typ}	10.6	15.3	15.6	12.9	W
Forward Voltage	V_{Fmin}	12.5	12.5	12.5	12.5	V
	V_F	13.4	14.8	13.2	13.1	V
	V_{Fmax}	16.0	16.0	16.0	16.0	V
FWHM at 50% of Φ	$\Delta\lambda_{1/2}$	13	13	17	17	nm

Absolute Minimum and Maximum Ratings³

Parameter	Symbol	Values				Unit
Peak Wavelength Range	λ	365 - 375	380-390	390-400	400-410	nm
Absolute Minimum Current (CW or Pulsed) ⁴	I_{f-min}	0.3	0.3	0.3	0.3	A
Absolute Maximum Current (CW) ⁴	$I_{f-max-cw}$	4.5	6	6	6	A
Absolute Maximum Repetative Surge Current ⁴ (Duty cycle >25%, t=1ms)	$I_{f-max-rs}$	6	7.5	7.5	7.5	A
Maximum Junction Temperature ⁵	T_{j-max}	125	125	125	125	°C
Storage Temperature Range	T_s	-40 to 100				°C
Total Emitting Area	A_e	20.7				mm ²
ESD Rating- Human Body Model	V_{HBM}	8				kV

Note 1: Data verified using NIST traceable calibration standard.

Note 2: Unless otherwise noted, values listed are typical. Devices are production tested and specified at 2.25 A (0.75 A/mm²) using a 20 ms pulse at 25°C.

Note 3: Typical total flux from emitting area at listed peak wavelength. Performance trends for a selected power level are shown in the graphs on page 6. For specific minimum and maximum values, use bin tables. For product roadmap and future performance of devices, contact Luminus.

Note 4: SBM-120-UV devices can be driven at currents ranging from 300 mA to 6 A (0.3 to 4.5A for 365-375 nm devices) and at duty cycles ranging from 1% to 100%. Drive current and duty cycle should be adjusted as necessary to maintain the junction temperature desired to meet application lifetime requirements..

Note 5: Lifetime is dependent on LED junction temperature. Input power and thermal system must be properly managed to ensure desired lifetime. Please contact Luminus for reliability information.

Optical & Electrical Characteristics

Relative Radiometric Flux vs Forward Current

$\phi_e/\phi_e(2.25A)$ Single Pulse 20ms $T_j = 25^\circ C$

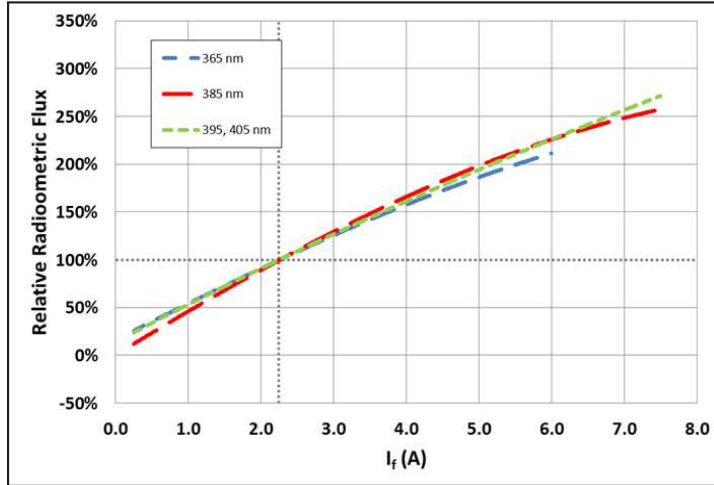

Relative Radiometric Flux vs T_j

$\phi_e/\phi_e(25^\circ C)$ Single Pulse 20ms $I_f = 2.25A$

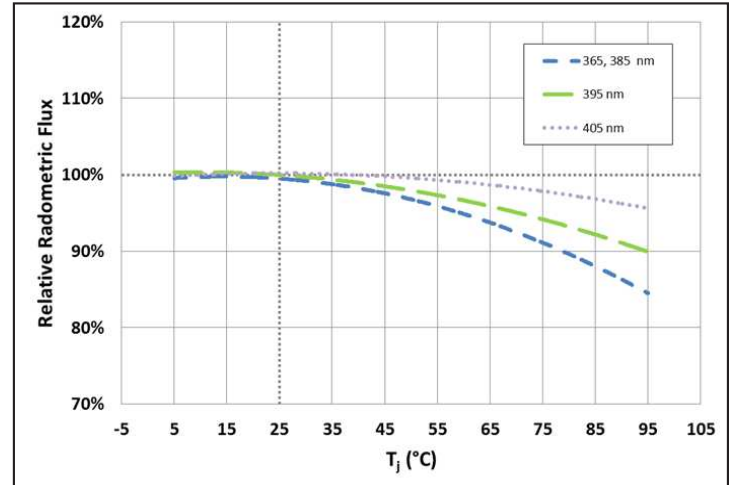

Delta Peak Wavelength vs Forward Current

$\lambda_p/\lambda_p(2.25A)$ Single Pulse 20ms $T_j = 25^\circ C$

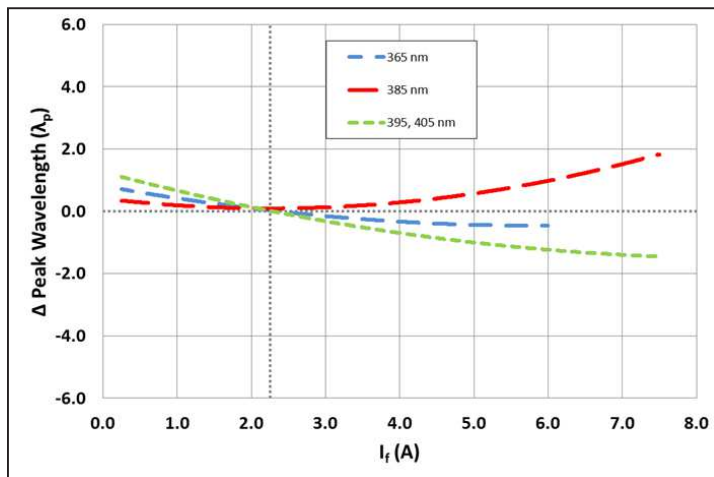

Delta Peak Wavelength vs T_j

$\lambda_p/\lambda_p(T_j)$ Single Pulse 20ms $I_f = 2.25A$

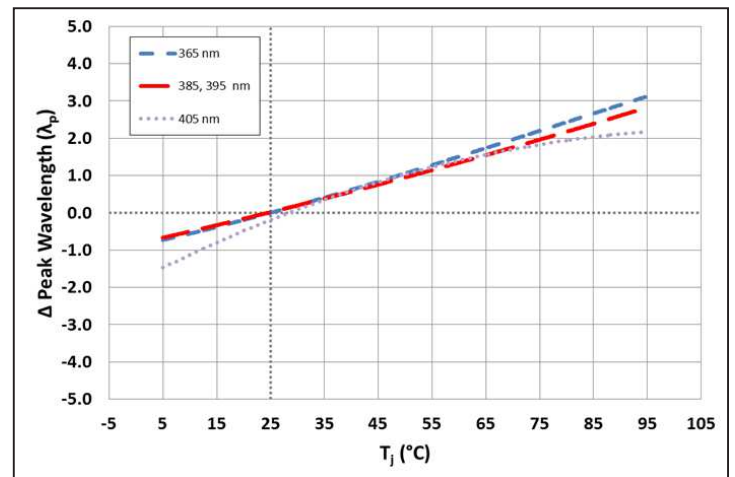

Optical & Electrical Characteristics

Forward Voltage vs Forward Current

$\Delta V_f = V(I_f) - V(2.25A)$ Single Pulse 20ms $T_j = 25^\circ C$

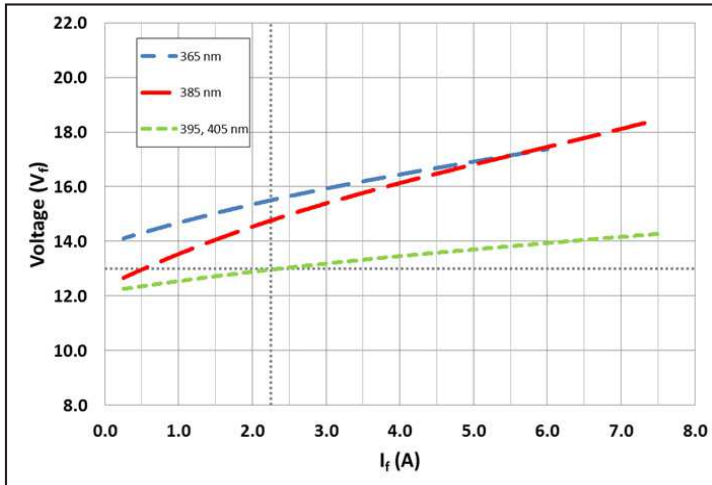

Delta Forward Voltage vs T_j

$\Delta V_f = V(T_j) - V(25^\circ C)$ Single Pulse 20ms I_f = 2.25A

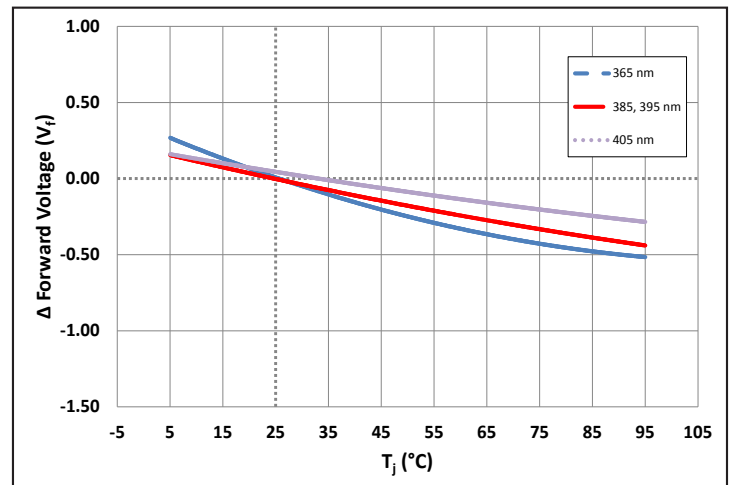

Typical Angular Distribution Pattern

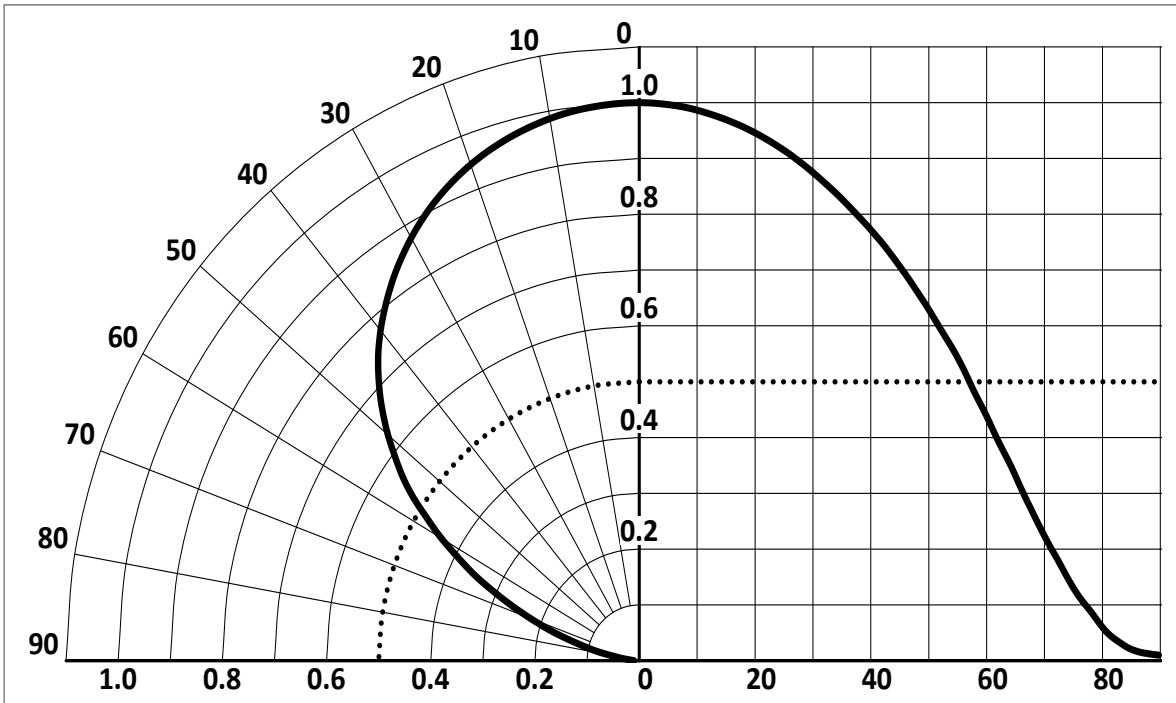

Typical Spectra

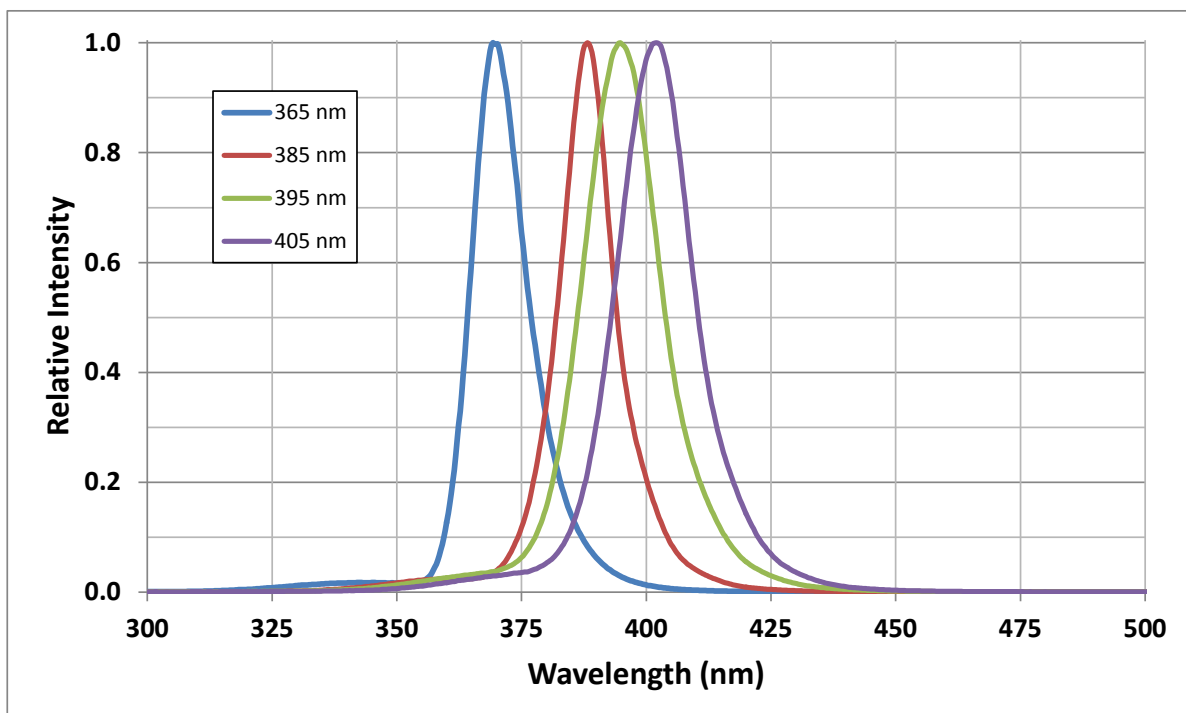

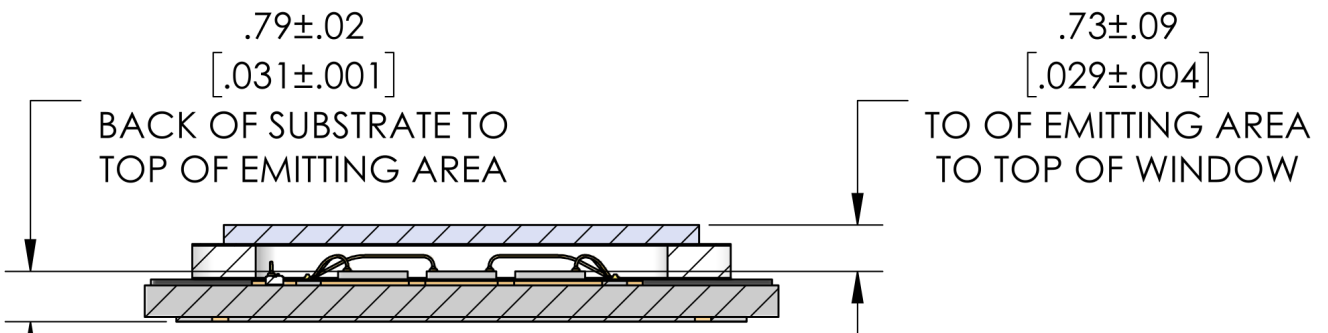
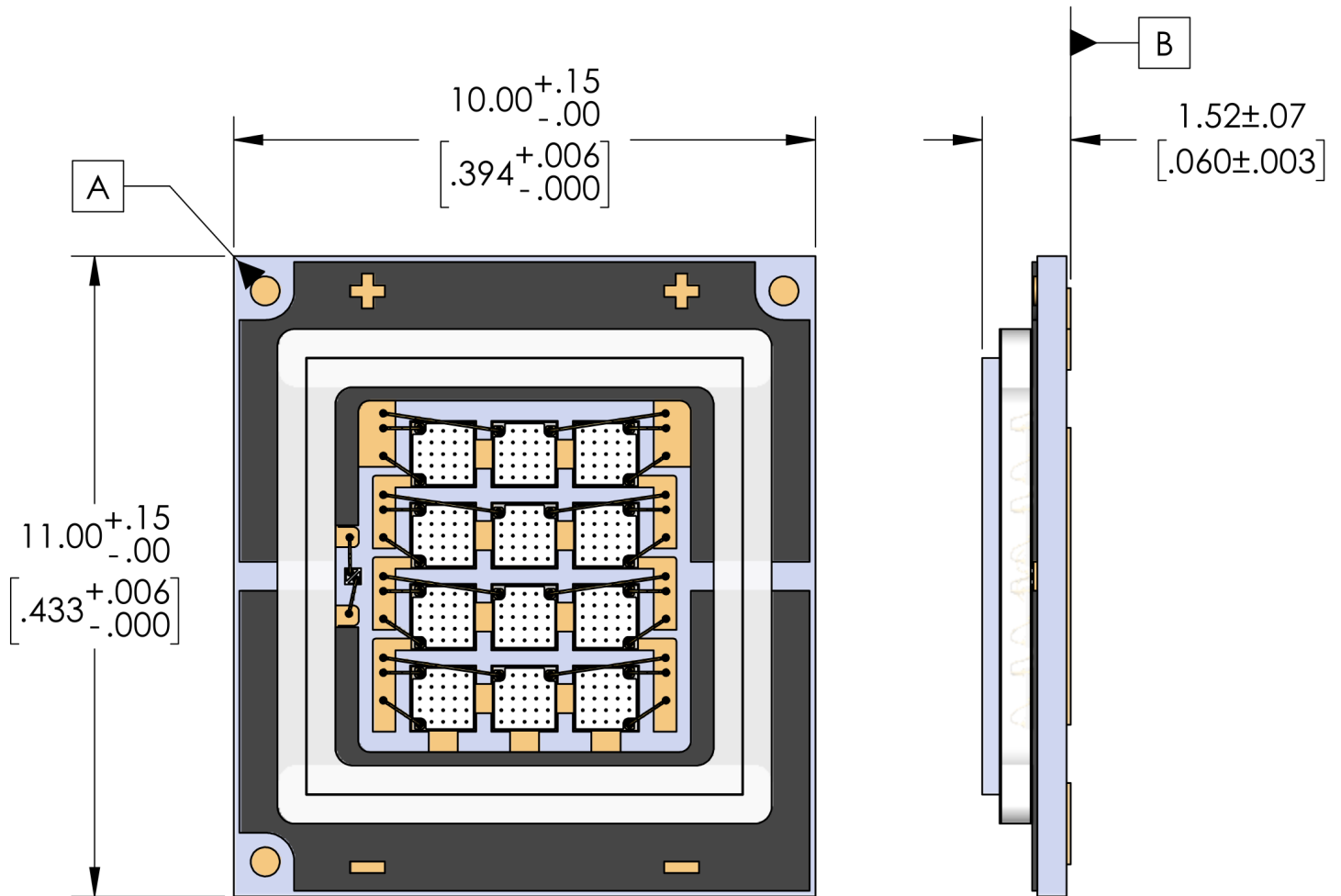
Mechanical Dimensions – SBM-120-UV-F34 Surface Mount Configuration^{1,2}

Note 1: Dimensions Are In Millimeters [Inches].

Note 2: For more details see Luminus drawing DWG-002867.

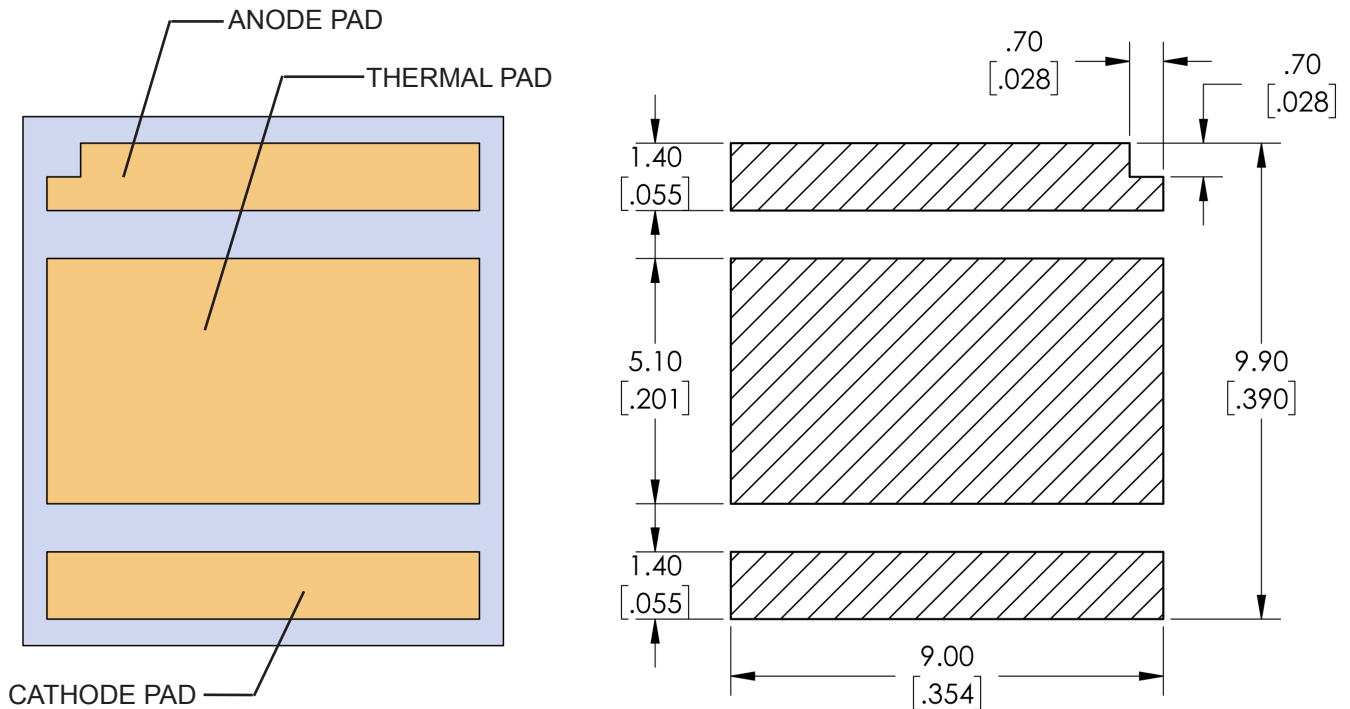
SBM-120-UV-F34 Surface Mount Configuration- Solder Pad Layout^{1,2}

RECOMMENDED SOLDER PAD LAYOUT

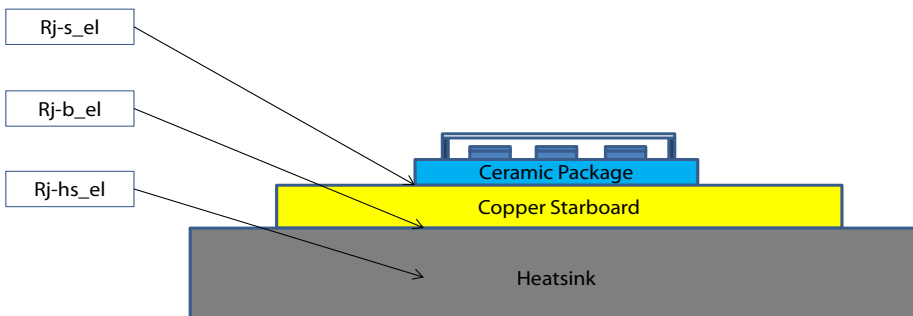
Note 1: Dimensions Are In Millimeters [Inches]
 Note 2: Recommended solder stencil thickness: .15 [.006].

Thermal Resistance^{3,4,5}

Typical Thermal Resistance

R _{j-s_el} ³	0.28 °C/W
R _{j-b_el} ⁴	0.40 °C/W
R _{j-hs_el} ⁵	0.52 °C/W

Note 3: Thermal resistance values are measured according to JEDEC JESD14 using a 3A source current. (1A/mm²).

Note 4: Thermal resistance is measured using a SAC305 solder, a copper starboard, and eGraf 1205 thermal interface material.

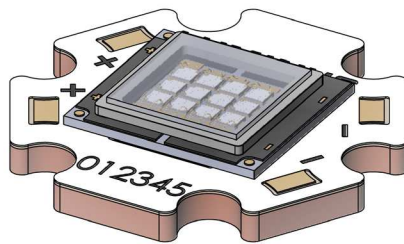
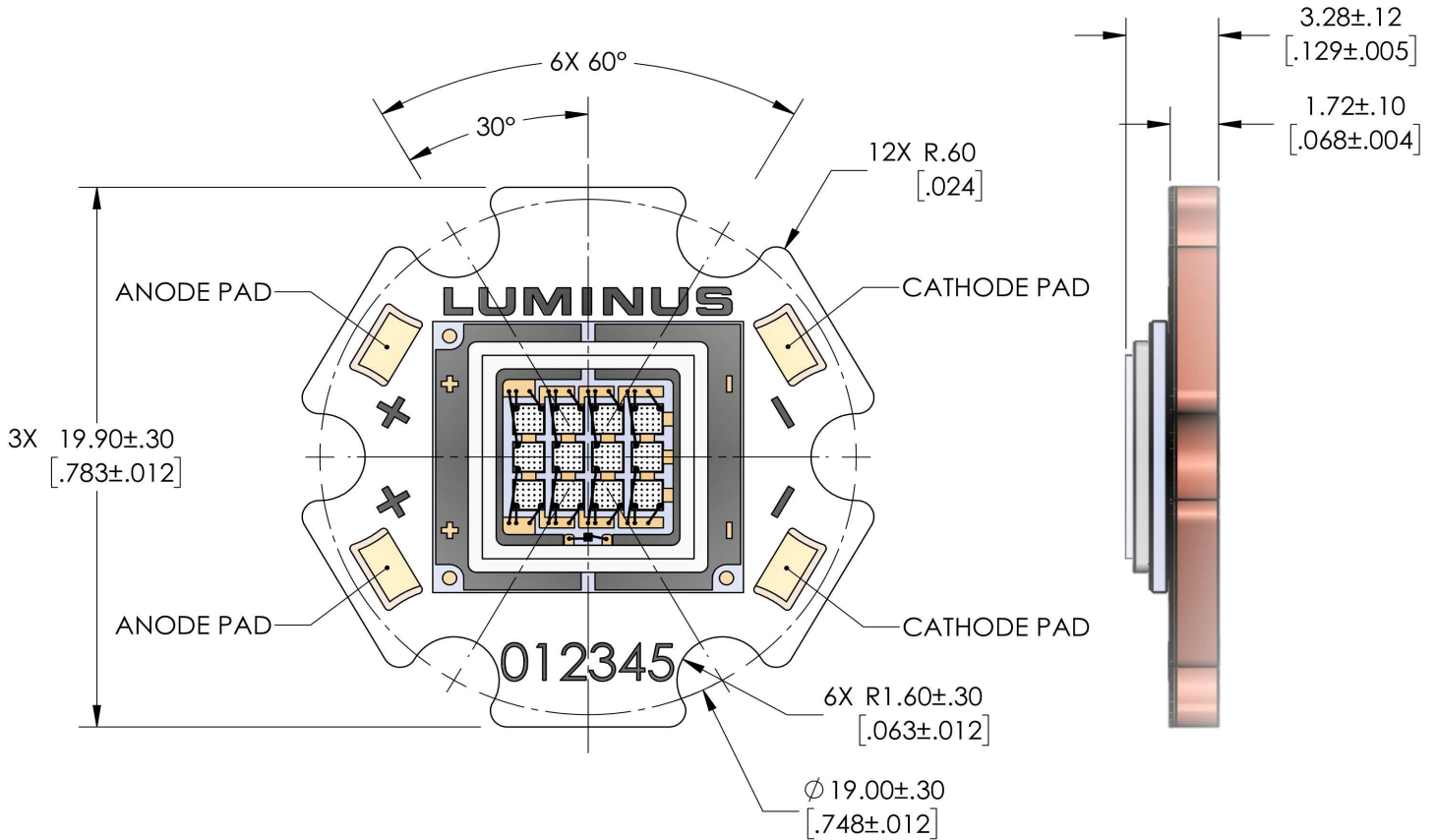
Note 5: All values are electrical thermal resistance based on input power.

Mechanical Dimensions – SBM-120-UV-R34 Star Board Configuration^{1,2,3,4,5,6}

Note 1: Tolerances per IPC-610, Class 2.

Note 2: Recommended mounting screw: M3 or #4.

Note 3: All dimensions in millimeters [mils].

Note 4: All anode pads on board are interconnected. All cathode pads on board are interconnected.

Note 5: Center of ceramic module to center of starboard is +/- 0.15[0.006].

Note 6: For more details, reference Luminus drawing DWG-002932.

Solder Profile

SAC 305 Reflow Profile Window For Low Density Boards

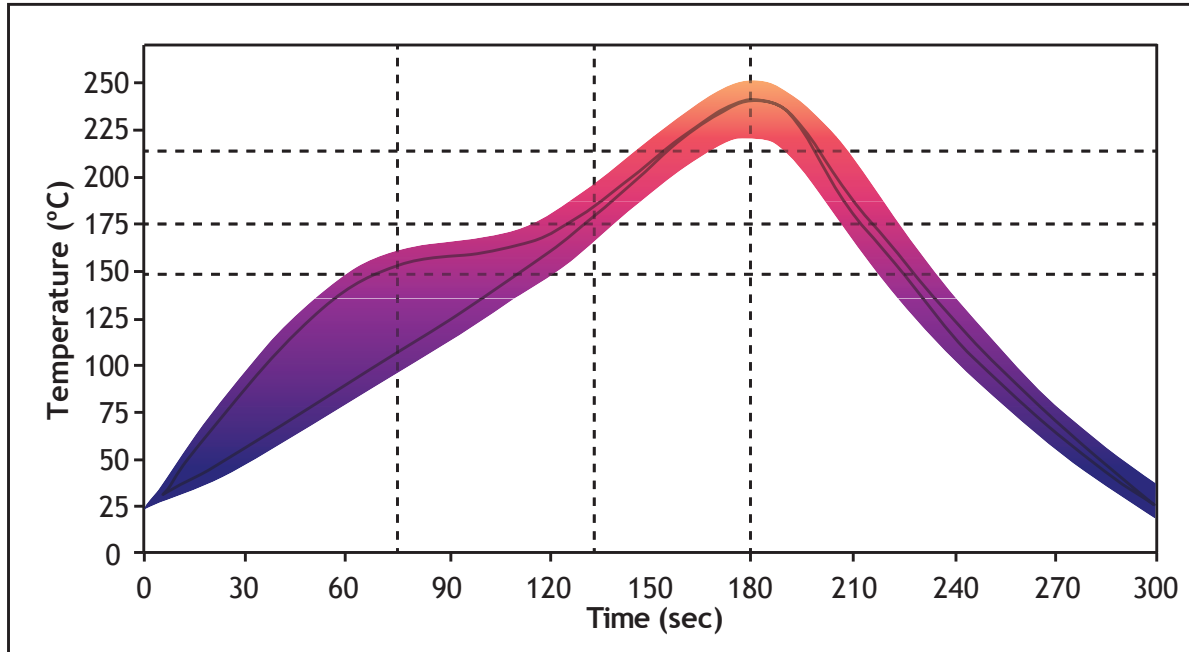

Lead free solder guideline for low density boards

Solder Profile Stage	Lead-Free Solder
Profile length, Ambient to Peak	2.75 - 3.5 minutes
Time above 217° C	30 - 60 seconds
Cooldown Rate	≤4° C/sec
Cooldown duration	45 ± 15 sec

Note 1: Temperatures are taken and monitored at the component copper layer.

Note 2: Optimum profile may differ due to oven type, circuit board or assembly layout.

Note 3: Recommended lead free, no-clean solder: AIM NC254-SAC305.

Note 4: Refer to APN-001473 soldering and handling application note for additional solder profiles and details.

Note 5: MSL- 1 Level.

Shipping Tray Outline-SBM-120-UV-F34 Surface Mount Configuration- Emitter

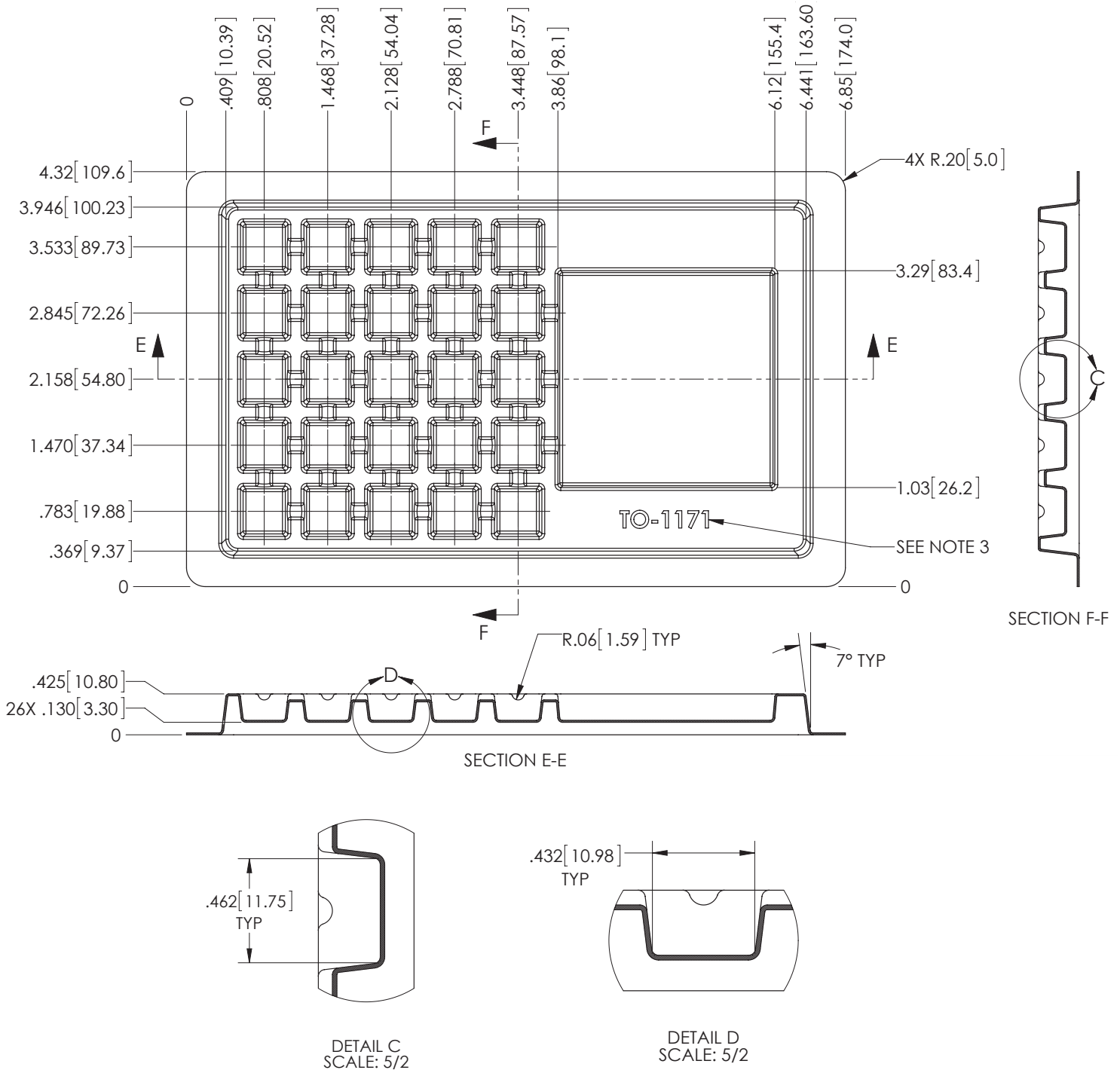

Note 1: Dimensions are in inches [millimeters].

Note 2: Each tray is covered with a top tray.

Note 2: For detailed drawing of shipping trays, please refer to Luminus document TO-1171 which is available upon request..

Shipping Tray Outline-SBM-120-UV-R34 Star Board Configuration¹

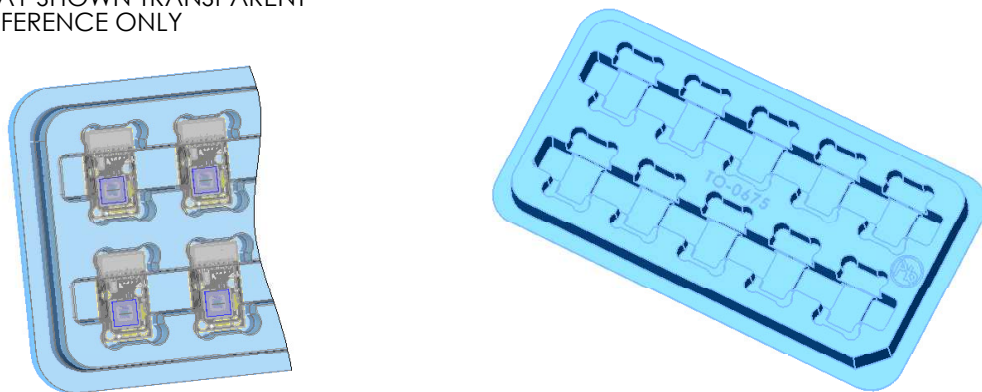
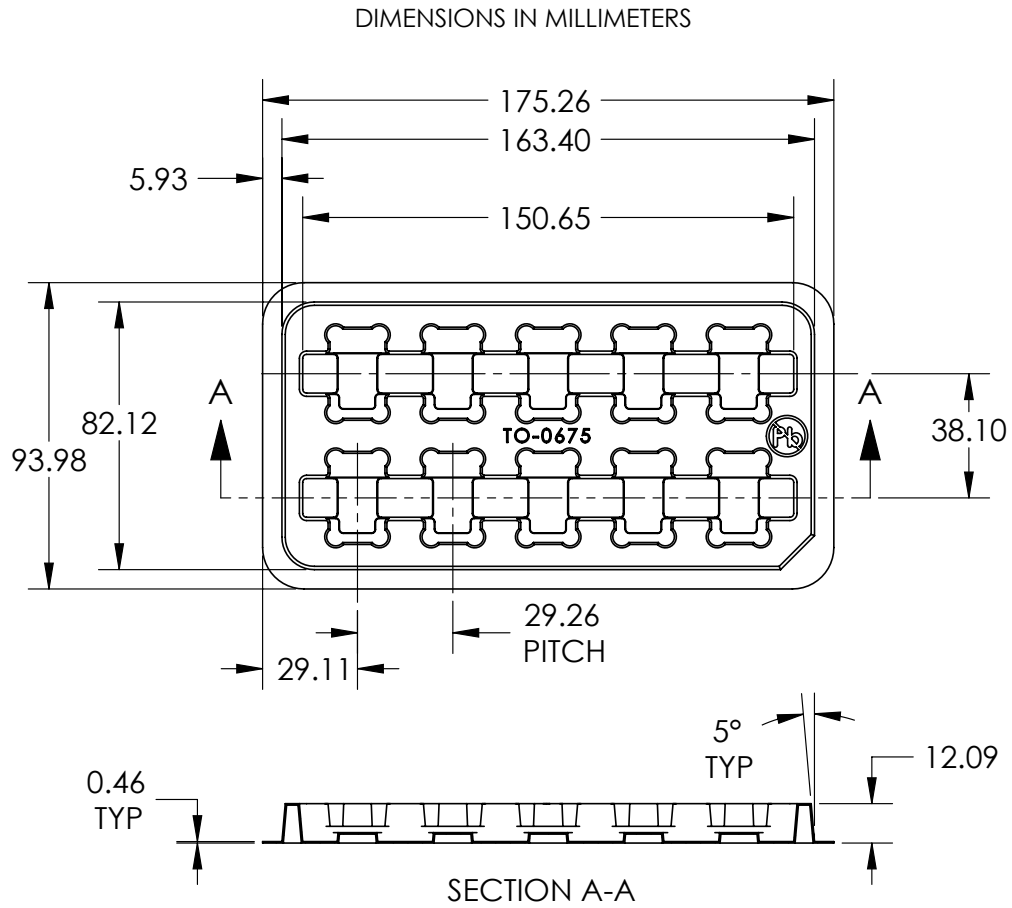

Note 1: For detailed drawing of shipping trays, please refer to Luminus document TO-0675 which is available upon request..

Packing and Shipping Specification

Packing Specification

Product Configuration	Packing Configuration	Qty /Pack	Dimensions (L x W x H, mm)
F34 - Surface Mount	Stack of 2 trays with 25 devices per tray Each pack is enclosed in ESD bag	50	174 x 110 x 22
R34 - Starboard	Single tray 10 devices Each pack is enclosed in ESD bag	10	175 x 74 x 12

Product Label Specification

Label Fields (subject to change):

- 6-8 digit Box number (for Luminus internal use)
- Luminus ordering part number
- Quantity of devices in pack
- Part number revision (for Luminus internal use)
- Customer's part number (optional)
- Bin (FF-WW) as defined page 3
- 2D Bar code



Sample label –for illustration only

Shipping Carton

Shipping Carton	Quantity	Material	Dimensions (L x W x H, mm)
Carton Box	1 -20 packs (50 - 1000 Devices)	S4651	560 x 560 x 200



History of Changes

Rev	Date	Description of Change
PDS-002839 Rev01	01/24/2017	Preliminary and pending final characterization updates
PDS-002839 Rev02	08/17/2017	Update characterization, bin kit offerings, and drawings. Add packaging information.

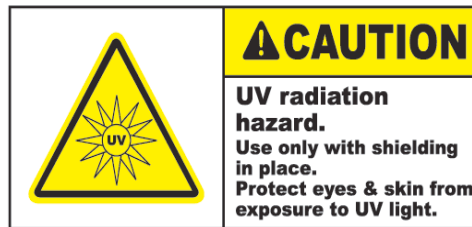

The products, their specifications and other information appearing in this document are subject to change by Luminus Devices without notice. Luminus Devices assumes no liability for errors that may appear in this document, and no liability otherwise arising from the application or use of the product or information contained herein. None of the information provided herein should be considered to be a representation of the fitness or suitability of the product for any particular application or as any other form of warranty. Luminus Devices' product warranties are limited to only such warranties as accompany a purchase contract or purchase order for such products. Nothing herein is to be construed as constituting an additional warranty. No information contained in this publication may be considered as a waiver by Luminus Devices of any intellectual property rights that Luminus Devices may have in such information.

This product is protected by U.S. Patents 6,831,302; 7,074,631; 7,083,993; 7,084,434; 7,098,589; 7,105,861; 7,138,666; 7,166,870; 7,166,871; 7,170,100; 7,196,354; 7,211,831; 7,262,550; 7,274,043; 7,301,271; 7,341,880; 7,344,903; 7,345,416; 7,348,603; 7,388,233; 7,391,059 Patents Pending in the U.S. and other countries.