



Chipsmall Limited consists of a professional team with an average of over 10 year of expertise in the distribution of electronic components. Based in Hongkong, we have already established firm and mutual-benefit business relationships with customers from,Europe,America and south Asia,supplying obsolete and hard-to-find components to meet their specific needs.

With the principle of “Quality Parts,Customers Priority,Honest Operation,and Considerate Service”,our business mainly focus on the distribution of electronic components. Line cards we deal with include Microchip,ALPS,ROHM,Xilinx,Pulse,ON,Everlight and Freescale. Main products comprise IC,Modules,Potentiometer,IC Socket,Relay,Connector.Our parts cover such applications as commercial,industrial, and automotives areas.

We are looking forward to setting up business relationship with you and hope to provide you with the best service and solution. Let us make a better world for our industry!



Contact us

Tel: +86-755-8981 8866 Fax: +86-755-8427 6832

Email & Skype: info@chipsmall.com Web: www.chipsmall.com

Address: A1208, Overseas Decoration Building, #122 Zhenhua RD., Futian, Shenzhen, China



SC-GU3 SERIES

Related Information

- General terms and conditions..... F-7
- FX-500 / FX-300 P.73~ / P.139~
- LS-500 / LS-400 / DPS-400 P.241~ / P.253~ / P.767~
- General precautions P.1501



panasonic.net/id/pidsx/global

Link digital sensors directly to open networks

To minimize life cycle cost

The continuously shortened life cycle of equipment has highlighted the importance of reduced costs during manufacturing and initial installation. Panasonic Industrial Devices SUNX offers a line of devices, the **SC-GU3** series communication units for open network, that maximize the capabilities of open networks, streamline regular maintenance and preventive maintenance, and reduce wiring and installation work. We offer solutions that minimize costs during the life cycle of equipment.

Traceability

It is useful to keep track of the sensor configurations at equipment start-up so that failures can be quickly identified and the user alerted.

Before When a failure occurs

It is hard to identify "what went wrong". Checking on the settings of each sensor one by one requires a great number of man-hours.

Difficult to identify the failure

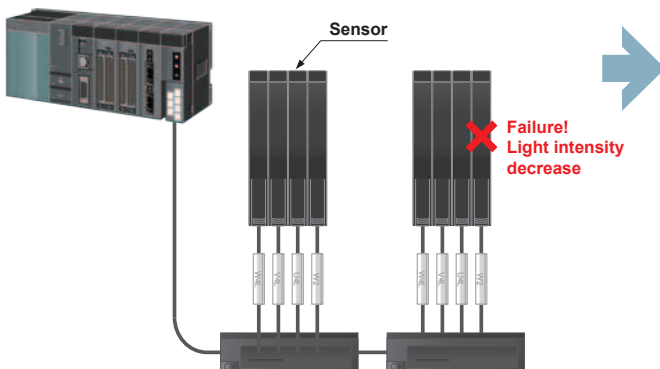

After When a failure occurs

It is easy to identify "what went wrong". By having the information of each sensor saved as "Configuration file", the traceability of the workload is reduced and incorrect input or setting loss is prevented.

Easy to identify the failure by checking

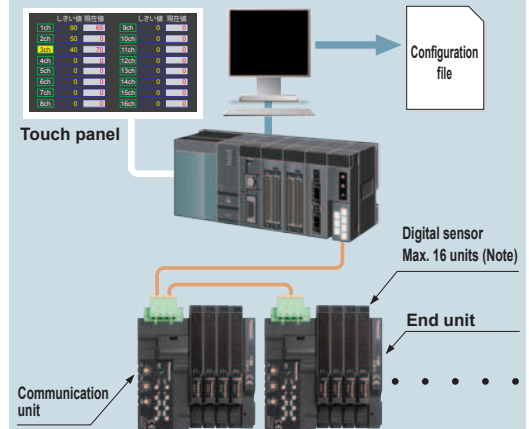

Note: Maximum of 12 units in case of including the FX-500 series.

Upper Communication Unit MIL Connector Plug-in

SC-GU3
SC-GU2-C
SC-GU1-485

Remote monitoring of equipment

Since the sensor settings can be checked over the network, it is possible to minimize the man-hours spent by field workers to resolve failures of equipment or line.

Before Current situation

Confirmation of sensor condition in detail via telephone or e-mail is required.



Consumes time to confirm the configuration condition.

In the worst case, a trip down to the actual worksite may be necessary.

After Connecting to network

Monitoring can be done via existing system or PC. Accurate situations can be confirmed so that actions can be taken correctly and swiftly.

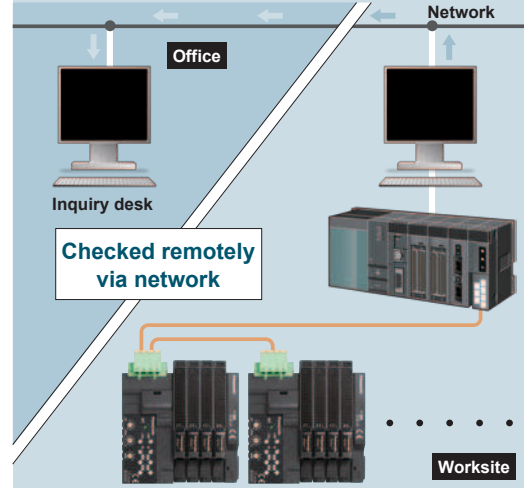

Streamline maintenance work

By saving the default settings as "Configuration file" when equipment was shipped out, sensor replacement can be smoothly performed by downloading via an open network. Replacement work is also easy, for sensor is equipped with connector that require no tools.

At equipment shipment

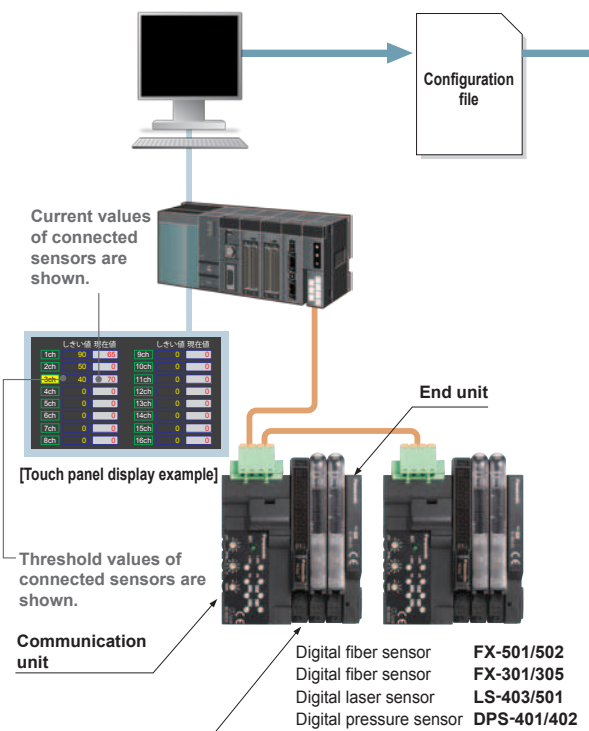

When replacing sensors

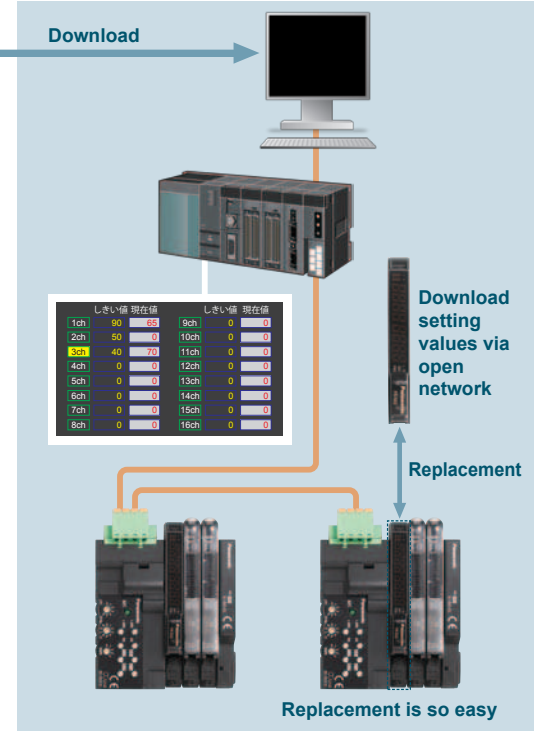

FIBER SENSORS

LASER SENSORS

PHOTOELECTRIC SENSORS

MICRO PHOTOELECTRIC SENSORS

AREA SENSORS

LIGHT CURTAINS / SAFETY COMPONENTS

PRESSURE / FLOW SENSORS

INDUCTIVE PROXIMITY SENSORS

PARTICULAR USE SENSORS

SENSOR OPTIONS

SIMPLE WIRE-SAVING UNITS

WIRE-SAVING SYSTEMS

MEASUREMENT SENSORS

STATIC ELECTRICITY PREVENTION DEVICES

LASER MARKERS

PLC

HUMAN MACHINE INTERFACES

ENERGY CONSUMPTION VISUALIZATION COMPONENTS

FA COMPONENTS

MACHINE VISION SYSTEMS

UV CURING SYSTEMS

Upper Communication Unit MIL Connector Plug-in

SC-GU3

SC-GU2-C

SC-GU1-485

- FIBER SENSORS
- LASER SENSORS
- PHOTOELECTRIC SENSORS
- MICRO PHOTOELECTRIC SENSORS
- AREA SENSORS
- LIGHT CURTAINS / SAFETY COMPONENTS
- PRESSURE / FLOW SENSORS
- INDUCTIVE PROXIMITY SENSORS
- PARTICULAR USE SENSORS
- SENSOR OPTIONS
- SIMPLE WIRE-SAVING UNITS
- WIRE-SAVING SYSTEMS
- MEASUREMENT SENSORS
- STATIC ELECTRICITY PREVENTION DEVICES
- LASER MARKERS
- PLC
- HUMAN MACHINE INTERFACES
- ENERGY CONSUMPTION VISUALIZATION COMPONENTS
- FA COMPONENTS
- MACHINE VISION SYSTEMS
- UV CURING SYSTEMS

Preventive maintenance

Observe digital data such as incident light intensity or pressure value of sensors and graph them for preventive maintenance.

Example: Decrease in incident light intensity due to dirt on fiber sensor.

Before Current situation

It is hard to keep track of the long-term fluctuations in sensors just with regular checking.

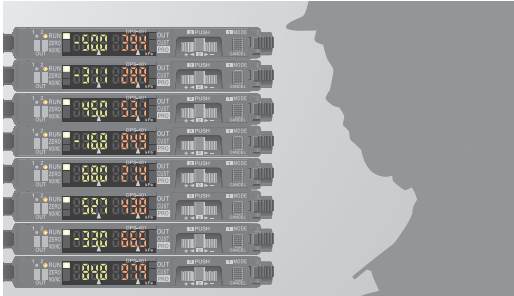

After Monitoring through network

By obtaining data and making them into a graph, it is possible to view long-term fluctuation patterns from which prediction of changes can be made.

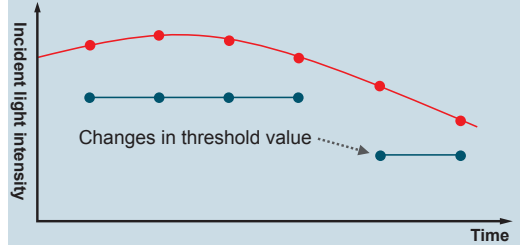

If the light intensity continues to decrease, then it is time to replace the sensor.
* To make a graph, it is necessary to compose a ladder separately.

Easy maintenance with the memory function

Store Settings of the connected digital sensors into the **SC-GU3** series. Just press the "Setting extension (EXT.)" key and setting data can be transmitted and restored to original status. Maintenance such as sensor replacement can be performed smoothly. Also, the settings stored in the **SC-GU3** series is checked against the settings of the digital sensors when the power is turned on. When the setting is different, memory function indicator (MEM.) will flash, and warning signal sent, preventing the equipment from operating with settings changed.

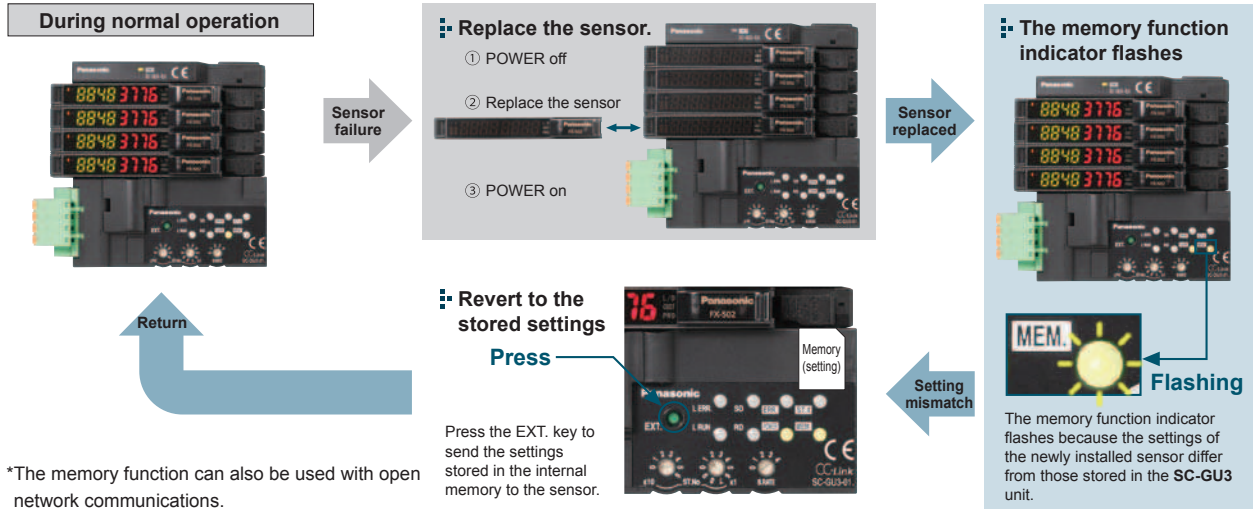

Reduction of wiring, construction, and space

Installation space for slave devices is eliminated. Cascade connection is simply done with connectors so that the time taken for wiring and construction can be reduced.

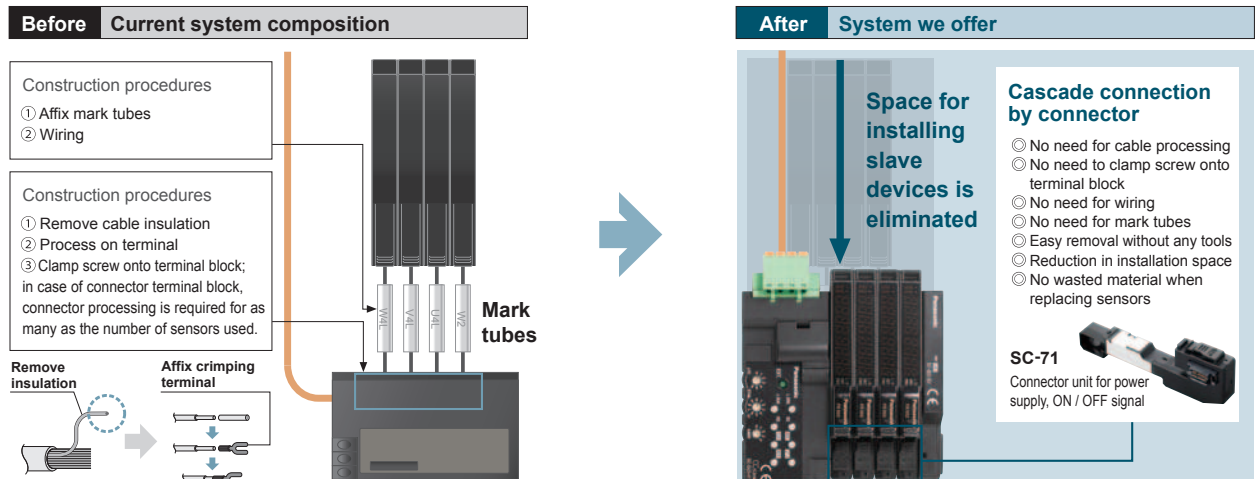

- Upper Communication Unit
- MIL Connector Plug-in

- SC-GU3
- SC-GU2-C
- SC-GU1-485

Space saving with open unit setting

Open unit (sensor) setting is achieved when performing the process for every 1 byte (sensor input for 8 units) in order to make the data control clear, or planning to add sensors later. In addition, the **SC-GU3** series minimizes installation space by reducing space required for all I/O units.

Example: In case of dividing 16 units into every 8 units and create open unit for 3 units each.

Before Conventional installation

Installation space and I/O unit of 16 units are required

I/O unit

After Installation with the SC-GU3 series

With the open unit setting, only installation space for 10 units is enough required

Space-saving

Example address settings including open units

Address	0	1	2	3	4	5	6	7	8	9	10	11	12	13	14	15
Input	1	1	1	1	1				1	1	1	1	1			
Output						1	1	1						1	1	1

* Open units are set to "output".

Make use of spare channels

Standard, general-purpose sensors can also be connected in cascade to the **SC-GU3** series with connector input units of **SC-A01**, **SC-A02**, **SC-E1**, **SC-E81** and **SC-E82**. Further wire-saving can be achieved.

*Analog output type devices can be connected to the **SC-A01** and **SC-A02** (1 to 5 V / 4 to 20 mA)

Connectable amplifiers

- Fiber sensor
- Inductive proximity sensor
- Laser sensor
- Pressure sensor



Connectable

- 8-channel connector input extension unit **SC-E81, SC-E82**
- 1-channel connector input extension unit **SC-E1, SC-A01, SC-A02**

Photoelectric sensor

Inductive proximity sensor

Micro photoelectric sensor

Standard photoelectric and inductive proximity sensors can be connected.

FIBER SENSORS

LASER SENSORS

PHOTOELECTRIC SENSORS

MICRO PHOTOELECTRIC SENSORS

AREA SENSORS

LIGHT CURTAINS / SAFETY COMPONENTS

PRESSURE / FLOW SENSORS

INDUCTIVE PROXIMITY SENSORS

PARTICULAR USE SENSORS

SENSOR OPTIONS

SIMPLE WIRE-SAVING UNITS

WIRE-SAVING SYSTEMS

MEASUREMENT SENSORS

STATIC ELECTRICITY PREVENTION DEVICES

LASER MARKERS

PLC

HUMAN MACHINE INTERFACES

ENERGY CONSUMPTION VISUALIZATION COMPONENTS

FA COMPONENTS

MACHINE VISION SYSTEMS

UV CURING SYSTEMS

Upper Communication Unit MIL Connector Plug-in

SC-GU3



SC-GU2-C

SC-GU1-485

- FIBER SENSORS
- LASER SENSORS
- PHOTOELECTRIC SENSORS
- MICRO PHOTOELECTRIC SENSORS
- AREA SENSORS
- LIGHT CURTAINS / SAFETY COMPONENTS
- PRESSURE / FLOW SENSORS
- INDUCTIVE PROXIMITY SENSORS
- PARTICULAR USE SENSORS
- SENSOR OPTIONS
- SIMPLE WIRE-SAVING UNITS
- WIRE-SAVING SYSTEMS
- MEASUREMENT SENSORS
- STATIC ELECTRICITY PREVENTION DEVICES
- LASER MARKERS
- PLC
- HUMAN MACHINE INTERFACES
- ENERGY CONSUMPTION VISUALIZATION COMPONENTS
- FA COMPONENTS
- MACHINE VISION SYSTEMS
- UV CURING SYSTEMS

Models that can be connected to the SC-GU3-0 (Use in combination with SC-71, with the exception of certain models)

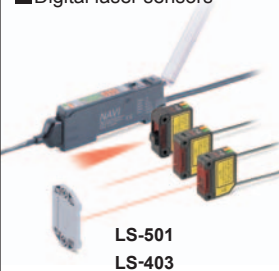
Sensors capable of communicating internal digital values (Models that support optical communications)

<p>■ Digital fiber sensors</p>  <p>FX-501 FX-301 (manufactured after June 2004) FX-502 FX-305</p>	<p>■ Digital laser sensors</p>  <p>LS-501 LS-403</p>	<p>■ Digital pressure sensors</p>  <p>DPS-401 DPS-402</p>	<p>■ Analog input units</p>  <p>SC-A01 SC-A02 SC-T1JA</p>
--	---	---	--

Sensors capable of communicating output information (ON / OFF) only (No optical communications)

Fiber sensors	FX-301 (manufactured before May 2004), FX-301 (B/G/H), FX-301-HS
Fiber sensors for manual setting	FX-411, FX-412, FX-311 (B/G)
Fiber sensors for leak / liquid fiber	FX-301-F, FX-301-F7
Laser sensors	LS-401
Compact inductive proximity sensors	GA-311
1-channel connector input extension unit	SC-E1, SC-T1J
8-channel connector input extension unit	SC-E81, SC-T8J (manufactured after June 2011; use in combination with SC-BU)
8-channel connector I/O mixed extension unit (2-wire type)	SC-E82, SC-TP8J (manufactured before June 2011; use in combination with SC-BU)
	No input signal indicator

Sensors can be replaced easily without detaching neighboring sensor amplifiers

Sensors are detachable simply by pushing down the lever of cascading connector unit and sliding the sensor amplifier sideways. This improves maintenance.

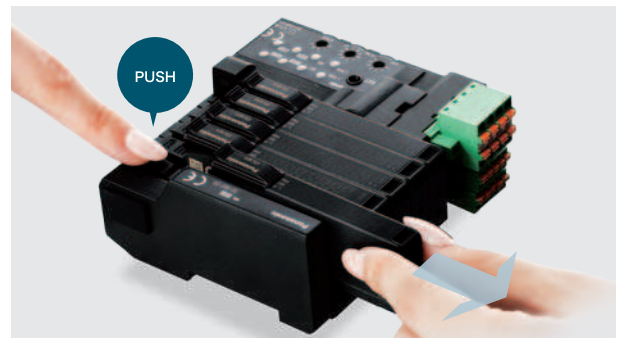

No tools needed

Sensor amplifier is equipped with one-touch connector, eliminating the need for tools.

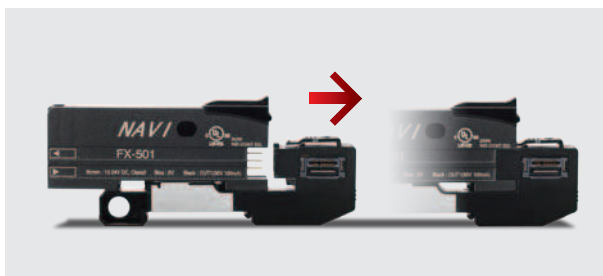

Optical communications for simple installation

Optical communications are used to send and receive data from the end units instead of a link cable. This facilitates easy installation and maintenance.



Parallel output connector

A parallel output connector allows the output signal from each sensor unit to be captured in real time.

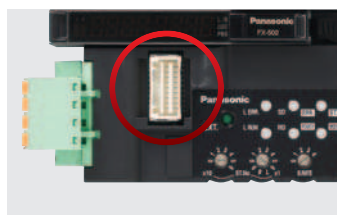

Cable orientation on the left side

All cable connections have been placed on the left side of the communication unit in order to make the most effective use of installation space.

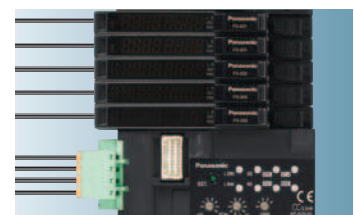

- Upper Communication Unit
- MIL Connector Plug-in
- SC-GU3**
- SC-GU2-C
- SC-GU1-485

COMMUNICATION UNIT FOR CC-Link

Support for Mitsubishi Electric's iQ Sensor Solution

SC-GU3-01

The **SC-GU3-01** Communication Unit for CC-Link is compatible with Mitsubishi Electric's iQ Sensor Solution (iQSS) and can be used in combination with products that support iQSS, for example Mitsubishi Electric's MELSEC series.

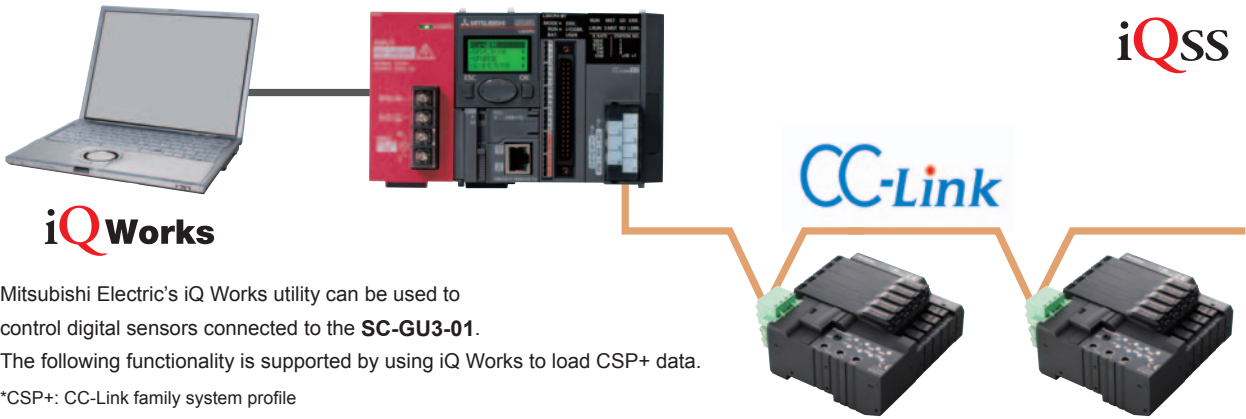

Mitsubishi Electric's iQ Works utility can be used to control digital sensors connected to the **SC-GU3-01**. The following functionality is supported by using iQ Works to load CSP+ data.
 *CSP+: CC-Link family system profile

- 1 CC-Link configuration information can be used to easily check the configuration of devices connected to the **SC-GU3-01** (sensor type [fiber, pressure, etc.], cascading configuration, number of units).
- 2 A list of sensor-specific parameter data (write / read) can be acquired and changed.
- 3 **SC-GU3-01** device allocations can be displayed by loading CSP+ data.
 (Note) This approach dramatically reduces the need to consult the **SC-GU3-01** specifications and manual.

*Capabilities include easy setup, sensor monitor, parameter read / write, and backup / restore. Requires Mitsubishi Electric's GX Works 2 sequencer engineering software Ver. 1.492 or later.

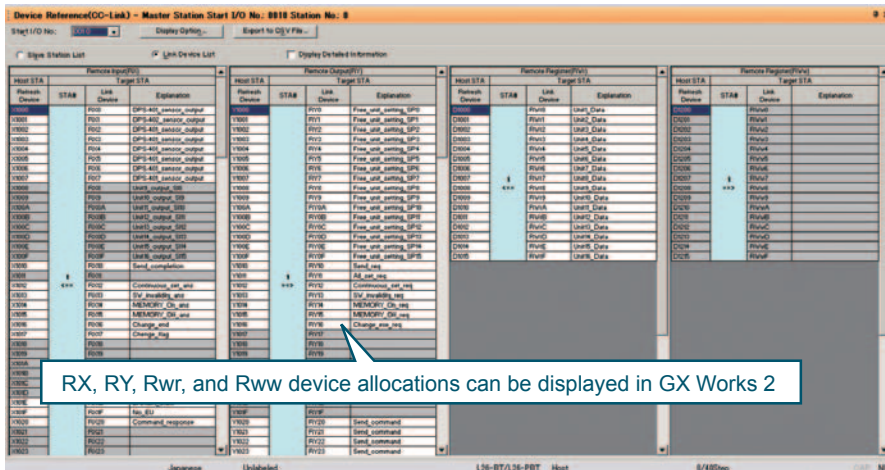
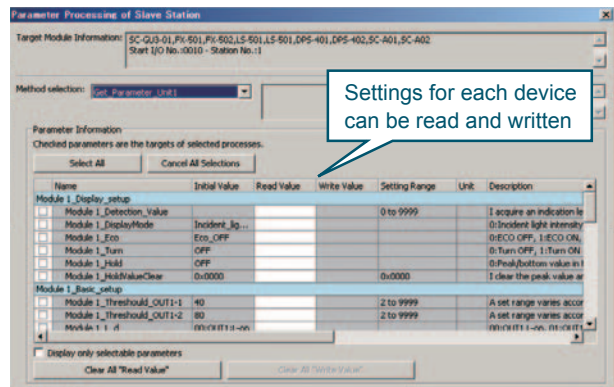
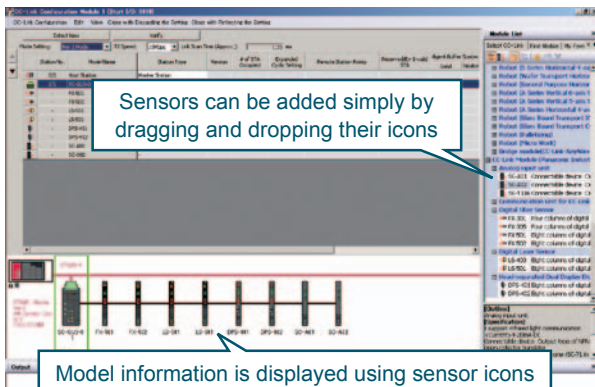

- FIBER SENSORS
- LASER SENSORS
- PHOTOELECTRIC SENSORS
- MICRO PHOTOELECTRIC SENSORS
- AREA SENSORS
- LIGHT CURTAINS / SAFETY COMPONENTS
- PRESSURE / FLOW SENSORS
- INDUCTIVE PROXIMITY SENSORS
- PARTICULAR USE SENSORS
- SENSOR OPTIONS
- SIMPLE WIRE-SAVING UNITS
- WIRE-SAVING SYSTEMS
- MEASUREMENT SENSORS
- STATIC ELECTRICITY PREVENTION DEVICES
- LASER MARKERS
- PLC
- HUMAN MACHINE INTERFACES
- ENERGY CONSUMPTION VISUALIZATION COMPONENTS
- FA COMPONENTS
- MACHINE VISION SYSTEMS
- UV CURING SYSTEMS
- Upper Communication Unit
- MIL Connector Plug-in
- SC-GU3
- SC-GU2-C
- SC-GU1-485

- FIBER SENSORS
- LASER SENSORS
- PHOTOELECTRIC SENSORS
- MICRO PHOTOELECTRIC SENSORS
- AREA SENSORS
- LIGHT CURTAINS / SAFETY COMPONENTS
- PRESSURE / FLOW SENSORS
- INDUCTIVE PROXIMITY SENSORS
- PARTICULAR USE SENSORS
- SENSOR OPTIONS
- SIMPLE WIRE-SAVING UNITS
- WIRE-SAVING SYSTEMS
- MEASUREMENT SENSORS
- STATIC ELECTRICITY PREVENTION DEVICES
- LASER MARKERS
- PLC
- HUMAN MACHINE INTERFACES
- ENERGY CONSUMPTION VISUALIZATION COMPONENTS
- FA COMPONENTS
- MACHINE VISION SYSTEMS
- UV CURING SYSTEMS
- Upper Communication Unit
- MIL Connector Plug-in
- SC-GU3**
- SC-GU2-C
- SC-GU1-485

Computer software for SC-GU3-01 with support for Mitsubishi Electric's EZSocket SC-PC1



The **SC-PC1** computer-based configuration application software supports ladderless manipulation of information (including sensor information) for **SC-GU3-01** units connected to CC-Link via the MELSEC series.

*Operations performed with the **SC-PC1** application cause communication commands to be sent and received.

SC-PC1 + EZSocket



List of connected devices

A list of slave devices can be acquired. (Note) The number of stations made by other manufacturers is also displayed.

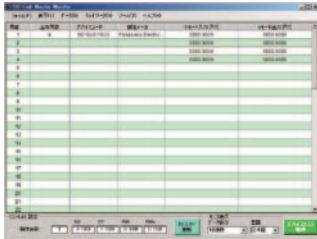

List of information about connected sensors

You can browse basic information for sensors connected to the **SC-GU3-01**. Settings can be changed.

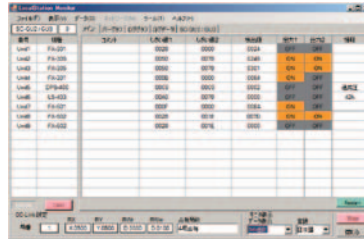

Two types of graphs

Browse change data for individual devices with the bar graph display or history and trend data with the log graph display.

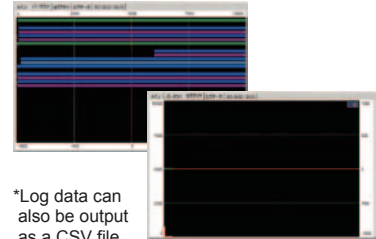

*Log data can also be output as a CSV file.

A traceability solution for sensor settings

The **SC-PC1** application can load sensor setting data. *Loaded values can be saved as a CSV file. Additionally, connected sensors can be checked against settings in the application.

This capability is useful when you wish to save settings at the time a device is shipped or check sensor settings as part of the troubleshooting process.

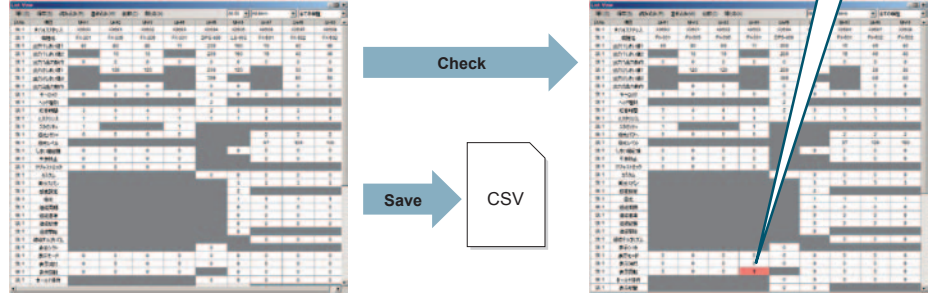

Distinguishing SC-GU3-01 versions that support iQSS

The **SC-GU3-01** gained iQSS support starting with units produced in December 2012, at which time the nameplate design was changed as shown below.

[Changes in appearance]

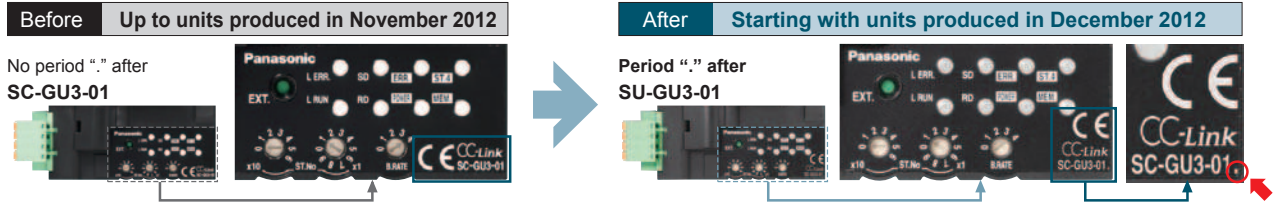

The upgraded model and older models can be distinguished by the period "." after the model No. (**SC-GU3-01**) on the bottom right of the nameplate.

SAMPLE PROGRAM WHEN USING A PROGRAMMABLE CONTROLLER AND TOUCH SCREEN

Easy configuration of all connected sensors

SC-GU3-01 / SC-GU3-02 / SC-GU3-03

Not only monitoring current values such as "incident light intensity" and "pressure values" of the digital sensor but also writing sensor setting changes can be performed over the open network.

Program development is simplified by downloading sample programs (screens and ladders) including methods for checking basic threshold and display values as well as basic settings for sensor amplifiers. The sample program's display language can be switched between English and Japanese.

*Communications commands are available that enable to check current values and sensor settings also to change settings using CC-Link / DeviceNet.

Screen image Sample program for the SC-GU3-01 Communication Unit for CC-Link

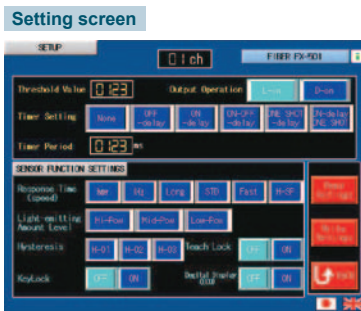

Press the Channel button

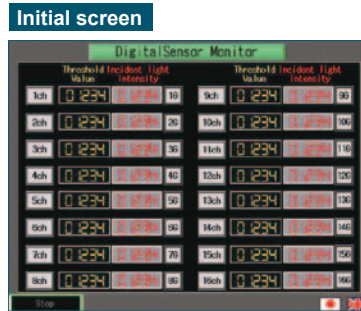

Press the Graph button

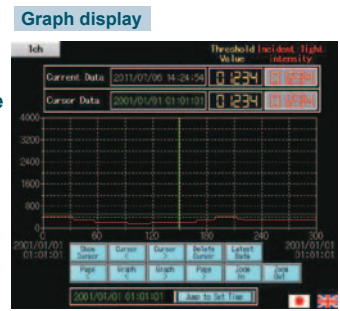

- Example for a digital fiber sensor
- Change threshold values and output operating settings.
- Change timer types and times.
- Vary the response speed, projection intensity level, hysteresis, etc.

- The channel display is linked to the sensor output, and the color changes.
- Displays a list of threshold values.
- Displays the current values.

- Change in current values can be plotted to easily show the amount of change over time.
- (Note) Data can be stored on a CF card.

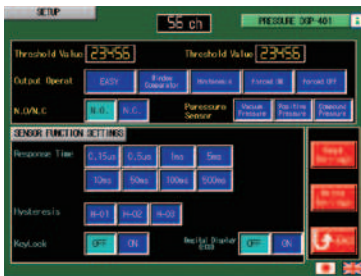

- Example for a digital pressure sensor
- Change threshold values.
- Configure sensing operation and NO / NC settings.
- Vary the response time, hysteresis, etc.



- Example for a digital laser sensor
- Change threshold values and output operating settings.
- Change timer types and times.
- Vary the response speed, sensing sensitivity, hysteresis, etc.

*Screen image is for the GOT1000 series of Mitsubishi Electric Corporation.

Display	Sequencer	Free downloads
GOT1000 series (Mitsubishi Electric Corporation)	MELSEC-Q series (Mitsubishi Electric Corporation)	Available for download from the Mitsubishi Electric and Panasonic Industrial Devices SUNX websites
GP3000 series (Digital Electronics Corporation)	Mitsubishi Electric Corporation	Available for download from the Digital Electronics website (from the "Connectable Device Samples" section under Pro-face / cockpit parts) (also works with the SC-GU2-C)

Screen image Sample program for the SC-GU3-02 Communication Unit for DeviceNet



Press the Channel button

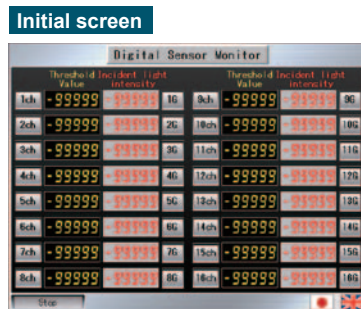

Press the Graph button

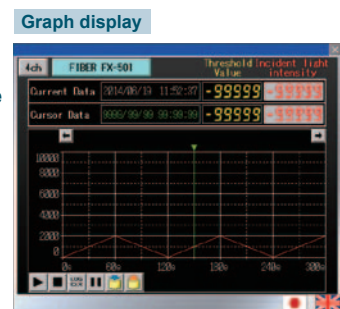

- Example for digital fiber sensors
- Change threshold values and output operating settings.
- Change timer types and times.
- Vary the response speed, sensing sensitivity, hysteresis, etc.

- The channel display is linked to the sensor output, and the color changes.
- Displays a list of threshold values.
- Displays the current values.

- Change in current values can be plotted to easily show the amount of change over time.

*Screens for digital pressure sensors and digital laser sensors are also available.

Display	Programmable controller	Free downloads
NS8 (Omron Corporation)	CJ1 / CS1 series (Omron Corporation)	Available for download from our website

FIBER SENSORS
LASER SENSORS
PHOTOELECTRIC SENSORS
MICRO PHOTOELECTRIC SENSORS
AREA SENSORS
LIGHT CURTAINS / SAFETY COMPONENTS
PRESSURE / FLOW SENSORS
INDUCTIVE PROXIMITY SENSORS
PARTICULAR USE SENSORS
SENSOR OPTIONS

SIMPLE WIRE-SAVING UNITS

WIRE-SAVING SYSTEMS

MEASUREMENT SENSORS

STATIC ELECTRICITY PREVENTION DEVICES

LASER MARKERS

PLC

HUMAN MACHINE INTERFACES

ENERGY CONSUMPTION VISUALIZATION COMPONENTS

FA COMPONENTS

MACHINE VISION SYSTEMS

UV CURING SYSTEMS

Upper Communication Unit
MIL Connector Plug-in

SC-GU3

SC-GU2-C

SC-GU1-485

Screen image PC Demonstration software for the SC-GU3-03 Communication Unit for EtherCAT

Initial screen

- Displays a list of threshold values.
- Displays the current value.
- Indicates the sensor output status.



Press the Setting button

Press the Graph button

Setting screen

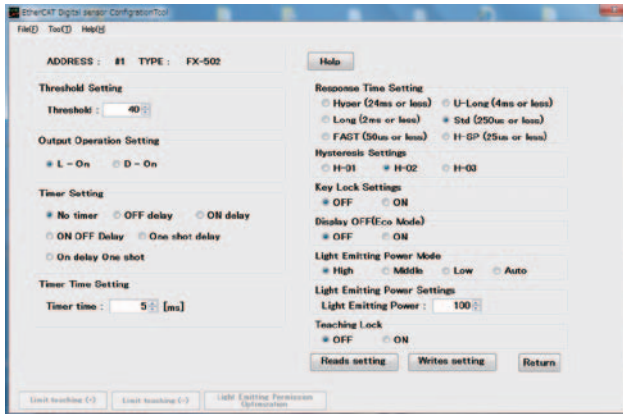

Graph display

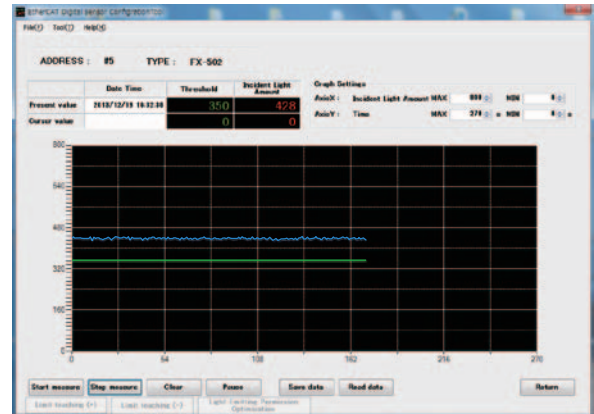

Example for digital fiber sensors

- Change threshold values and output operating settings.
- Configure timer types and times.
- Configure the response speed, hysteresis, beam emission power, and other settings.

- Change in current values can be plotted on a chart and the amount of change can be checked over time.

Type	Free downloads
PC Demonstration software (supports software from acontis technologies)	Available for download from our website

*EC-STA software from acontis technologies is required. For more information about EC-STA, please contact acontis technologies.

SYSTEM COMPOSITION

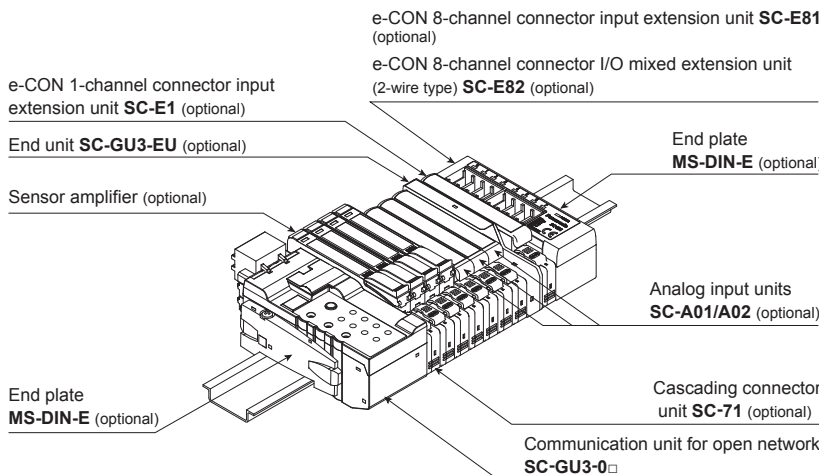

*If optical communication is to be used in a system that includes models not compatible with optical communication, connect the incompatible models after the **SC-GU3-EU**. A maximum of 12 units can be connected to the **FX-500** series, and a maximum of 16 units can be connected to the other sensor amplifiers.









Upper Communication Unit MIL Connector Plug-in

SC-GU3



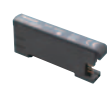

SC-GU2-C

SC-GU1-485

ORDER GUIDE

Designation	Appearance	Model No.	Description
Communication unit for CC-Link		SC-GU3-01	This is a communication unit, which can convert the output signal of a sensor amplifier into communication data for CC-Link.
Communication unit for DeviceNet		SC-GU3-02	This is a communication unit, which can convert the output signal of a sensor amplifier into communication data for DeviceNet.
Communication unit for EtherCAT		SC-GU3-03	This is a communication unit, which can convert the output signal of a sensor amplifier into communication data for EtherCAT.
End unit		SC-GU3-EU	This end unit can change and check the settings of sensor amplifiers that allow optical communication and monitor operation status.
Cascading connector unit		SC-71	This one-touch connector is used to connect the following devices to SC-GU3-0□ : The FX-500 / 400 / 300 fiber sensor, the LS-403 / 501 laser sensor, the DPS-400 digital pressure sensor, SC-E1 , SC-A01 and SC-A02 , etc.
e-CON 1-channel connector input extension unit		SC-E1	This extension unit can be connected to commercially available devices including an NPN output type or DC 2-wire type sensor. Includes power and input signal indicators (for one channel). When using in combination with the SC-GU3 series, use with the SC-71 .
e-CON 8-channel connector input extension unit		SC-E81	This extension unit can be connected to eight NPN output type devices. Includes power and input signal indicators (for eight channels).
e-CON 8-channel connector I/O mixed extension unit (2-wire type)		SC-E82	This extension unit can be connected to eight commercially available devices including DC 2-wire sensors. Includes a power indicator. Does not include an input signal indicator.
Analog voltage input unit		SC-A01	This extension unit can be connected to NPN output type devices or analog voltage output type devices. When using in combination with the SC-GU3 series, use with the SC-71 .
Analog current input unit		SC-A02	This extension unit can be connected to NPN output type devices or analog current output type devices. When using in combination with the SC-GU3 series, use with the SC-71 .

OPTIONS

Designation	Appearance	Model No.	Description
Compatible installation tool for SC		SC-BUX10 10 pcs. per set	This tool is used to install units for the SC-GU2 Series. SC-T8J manufactured since June 2011 can be used.
End plate		MS-DIN-E 10 pcs. per set	These end plates secure the SC-GU3-0□ , sensor amplifiers, analog input units, the SC-GU3-EU , extension units, and other devices that have been configured in a cascading connection on DIN rails by holding them in place from both sides. Be sure to use end plates.
Computer software for CC-Link		SC-PC1	This software makes it possible to use a computer to monitor current sensor values, save setting information to a CSV file, display log data, save log data to a CSV file, etc.
Cable with connector on one end		CN-M20-C2	This cable has a connector for linking to the parallel output signal.

FIBER
SENSORSLASER
SENSORSPHOTOELECTRIC
SENSORSMICRO
PHOTOELECTRIC
SENSORSAREA
SENSORSLIGHT CURTAINS /
SAFETY
COMPONENTSPRESSURE /
FLOW
SENSORSINDUCTIVE
PROXIMITY
SENSORSPARTICULAR
USE SENSORSSENSOR
OPTIONSSIMPLE
WIRE-SAVING
UNITSWIRE-SAVING
SYSTEMSMEASUREMENT
SENSORSSTATIC ELECTRICITY
PREVENTION
DEVICESLASER
MARKERS

PLC





HUMAN MACHINE
INTERFACESENERGY CONSUMPTION
VISUALIZATION
COMPONENTS

FA COMPONENTS

MACHINE VISION
SYSTEMSUV CURING
SYSTEMSUpper
Communication Unit
MIL Connector
Plug-in**SC-GU3****SC-GU2-C****SC-GU1-485**

ORDER GUIDE

Optical communication compatible amplifier

Type		Appearance	Model No.	Combined head	Description
Digital fiber sensor	FX-500 series		FX-501	FT-□ FD-□	NPN open-collector transistor
			FX-502		NPN open-collector transistor two outputs (Note 1)
	FX-300 series		FX-301		NPN open-collector transistor
			FX-305		NPN open-collector transistor two outputs (Note 1)
Digital laser sensor			LS-501	LS-H□	NPN open-collector transistor (Note 2)
			LS-403		NPN open-collector transistor
Digital pressure sensor	For combined pressure / negative pressure		DPS-401	DPH-101□ DPH-103□	NPN open-collector transistor two outputs (Note 1)
	For positive pressure		DPS-402		

Notes: 1) To receive the output signal from the Output 2, it is required to perform optical communication by simultaneously using the end unit **SC-GU3-EU**.
 2) The communication unit for EtherCAT **SC-GU3-03** cannot communicate internal digital value with **LS-501**.

SPECIFICATIONS

Designation		Communication unit for CC-Link					
Item	Model No.	SC-GU3-01					
Number of connectable units		Max. 16 units per SC-GU3-01 (Max. 12 units including FX-500 series)					
Supply voltage		24 V DC $\pm 1\%$ Ripple P-P 10 % or less					
Current consumption		120 mA or less (excluding connected sensor amplifiers)					
Allowable passing current		Wire-saving connector 2 A (Note 1), supply connector 6 A (Note 2)					
Communication method		CC-Link Ver.1.10					
Number of occupied station		Switchable 1 or 4 station					
Baud rate		10 Mbps	5 Mbps	2.5 Mbps	625 kbps	156 kbps	
Total extension length		100 m 328.084 ft	150 m 492.126 ft	200 m 656.168 ft	600 m 1968.504 ft	1,200 m 3937.008 ft	
Communication cable		Specified cable (twist pair cable with shield) (Note 3)					
Station No. setting		1 to 64 (0 and 65 or more: Error)					
Remote station type		Remote device station					
Ambient temperature		-10 to +55 °C +14 to +131 °F (No dew condensation or icing allowed), (if 4 to 7 units are connected in cascade: -10 to +50 °C +14 to +122 °F, if 8 to 16 units are connected in cascade: -10 to +45 °C +14 to +113 °F) Storage: -20 to +70 °C -4 to +158 °F					
Ambient humidity		35 to 85 % RH, Storage: 35 to 85 % RH					
Material		Enclosure: Polycarbonate					
Weight		Net weight: 80 g approx., Gross weight: 120 g approx.					

Notes: 1) Be sure to check that total current consumption of sensor amplifiers connected in cascade does not exceed allowable passing current.
 2) In case of supplying power to other devices, be sure to set the current less than allowable passing current.
 3) Use the CC-Link-specified cable.

Designation		Communication unit for DeviceNet		
Item	Model No.	SC-GU3-02		
Number of connectable units		Max. 16 units per SC-GU3-02 (Max. 12 units including FX-500 series)		
Supply voltage		11 to 25 V DC Ripple P-P 10 % or less		
Current consumption		80 mA or less (at 24 V) (excluding connected sensor amplifiers)		
Allowable passing current		Wire-saving connector 2 A (Note 1)		
Communication method		DeviceNet compliant		
Baud rate		500 kbps	250 kbps	125 kbps
Total extension length		100 m 328.084 ft (thick cable)	250 m 820.21 ft (thick cable)	500 m 1640.42 ft (thick cable)
		100 m 328.084 ft (thin cable)	100 m 328.084 ft (thin cable)	100 m 328.084 ft (thin cable)
Communication cable		Complies with DeviceNet standards (Note 2)		
Address setting		0 to 63 (64 or more: Error)		
Supported functions		I/O communication (Poll), Explicit message communication		
Ambient temperature		-10 to +55 °C +14 to +131 °F (No dew condensation or icing allowed), (if 4 to 7 units are connected in cascade: -10 to +50 °C +14 to +122 °F, if 8 to 16 units are connected in cascade: -10 to +45 °C +14 to +113 °F) Storage: -20 to +70 °C -4 to +158 °F		
Ambient humidity		35 to 85 % RH, Storage: 35 to 85 % RH		
Material		Enclosure: Polycarbonate		
Weight		Net weight: 75 g approx., Gross weight: 120 g approx.		

Notes: 1) Be sure to check that total current consumption of sensor amplifiers connected in cascade does not exceed allowable passing current.
 2) Use a special cable for DeviceNet that complies with the DeviceNet standards.

FIBER SENSORS
 LASER SENSORS
 PHOTO-ELECTRIC SENSORS
 MICRO PHOTO-ELECTRIC SENSORS
 AREA SENSORS
 LIGHT CURTAINS / SAFETY COMPONENTS
 PRESSURE / FLOW SENSORS
 INDUCTIVE PROXIMITY SENSORS
 PARTICULAR USE SENSORS
 SENSOR OPTIONS
 SIMPLE WIRE-SAVING UNITS
 WIRE-SAVING SYSTEMS
 MEASUREMENT SENSORS
 STATIC ELECTRICITY PREVENTION DEVICES
 LASER MARKERS
 PLC

HUMAN MACHINE INTERFACES
 ENERGY CONSUMPTION VISUALIZATION COMPONENTS
 FA COMPONENTS
 MACHINE VISION SYSTEMS
 UV CURING SYSTEMS
 Upper Communication Unit
 MIL Connector Plug-in
SC-GU3
SC-GU2-C
SC-GU1-485

SPECIFICATIONS

Designation	Communication unit for EtherCAT
Item / Model No.	SC-GU3-03
Number of connectable units	Max. 16 units per one SC-GU3-03 (Max. 12 units including FX-500 series)
Supply voltage	24 V DC ±10 % Ripple P-P 10 % or less
Current consumption	100 mA or less (excluding connected sensor amplifiers)
Allowable passing current	Wire-saving connector 2 A (Note 1)
Compliance standard	IEEE802.3u
Baud rate	100 Mbps
Communication cable	Category 5e
Internodal distance	100 m 328.084 ft
Communication ports	RJ45×2
EtherCAT communication standards	Process data communication, Mailbox communication
Ambient temperature	-10 to +55 °C +14 to +131 °F (No dew condensation or icing allowed), (If 4 to 7 units are connected in cascade: -10 to +50 °C +14 to +122 °F , if 8 to 16 units are connected in cascade: -10 to +45 °C +14 to +113 °F) Storage: -20 to +70 °C -4 to +158 °F
Ambient humidity	35 to 85 % RH, Storage: 35 to 85 % RH
Material	Enclosure: Polycarbonate
Weight	Net weight: 75 g approx., Gross weight: 120 g approx.

EtherCAT is a registered trademark of Beckhoff Automation GmbH.

Notes: 1) Be sure to check that total current consumption of sensor amplifiers connected in cascade does not exceed allowable passing current.
2) XML file can be downloaded from our website.

Designation	e-CON 1-channel connector input extension unit
Item / Model No.	SC-E1
Supply voltage	12 to 24 V DC ±10%
Current consumption	20 mA or less (with all indicators on) (Note)
Number of signals	1 input
Input	Connectable devices: NPN open-collector transistor output type (Input 1) and DC 2-wire output type (Input 2) sensors, switches, and other devices Current supply for input device: 100 mA or less Input impedance: Approx. 17 kΩ (Input 1) or approx. 3.2 kΩ (Input 2)
Output	NPN open-collector transistor • Maximum sink current: 50 mA • Applied voltage: 30 V DC or less (between output and 0 V) • Residual voltage: 1.5 V or less (with sink current of 50 mA)
Power indicator	Green LED (lights up when the power is ON)
Input indicator	Green LED (lights up when input is being received by unit)
Ambient temperature	-10 to +55 °C +14 to +131 °F (No dew condensation or icing allowed), (If 4 to 7 units are connected in cascade: -10 to +50 °C +14 to +122 °F , if 8 to 16 units are connected in cascade: -10 to +45 °C +14 to +113 °F) Storage: -20 to +70 °C -4 to +158 °F
Ambient humidity	35 to 85 % RH, Storage: 35 to 85 % RH
Material	Enclosure: Flame-resistant PBT, Connector: Polyester
Weight	Net weight: 15 g approx., Gross weight: 40 g approx.
Accessory	Connector (e-CON): 1

Note: Does not include current consumption or input current for connected input devices.

Designation	e-CON 8-channel connector I/O mixed extension unit (2-wire type)
Item / Model No.	SC-E82
Supply voltage	5 to 24 V DC ±10%
Current consumption	7 mA or less
Number of signals	8 inputs (Note)
Input	Connectable devices: Commercially available devices including a DC 2-wire type sensor Current supply for input devices: 800 mA or less (total for 8 inputs)
Power indicator	Green LED (Lights up when the power is ON)
Ambient temperature	-10 to +55 °C +14 to +131 °F (No dew condensation or icing allowed), (If 4 to 7 units are connected in cascade: -10 to +50 °C +14 to +122 °F , if 8 to 9 units are connected in cascade: -10 to +45 °C +14 to +113 °F) Storage: -20 to +70 °C -4 to +158 °F
Ambient humidity	35 to 85 % RH, Storage: 35 to 85 % RH
Material	Enclosure: Polycarbonate, Connector: Polyester
Weight	Net weight: 40 g approx., Gross weight: 85 g approx.

Note: Uses eight channels of signaling, regardless of the number of connected input devices.

Designation	End unit
Item / Model No.	SC-GU3-EU
Number of connectable units	1 unit for 1 communication unit
Supply voltage	11 to 25 V DC Ripple P-P 10 % or less
Current consumption	25 mA or less
Power indicator	Green LED (Lights up when the power is ON)
Ambient temperature	-10 to +55 °C +14 to +131 °F (No dew condensation or icing allowed), (If 4 to 7 units are connected in cascade: -10 to +50 °C +14 to +122 °F , if 8 to 16 units are connected in cascade: -10 to +45 °C +14 to +113 °F) Storage: -20 to +70 °C -4 to +158 °F
Ambient humidity	35 to 85 % RH, Storage: 35 to 85 % RH
Material	Enclosure: Polycarbonate
Weight	Net weight: 20 g approx., Gross weight: 20 g approx.

Designation	Cascading connector unit
Item / Model No.	SC-71
Number of connectable units	Max. 16 units per 1 communication unit
Ambient temperature	-10 to +55 °C +14 to +131 °F (No dew condensation or icing allowed), (If 4 to 7 units are connected in cascade: -10 to +50 °C +14 to +122 °F , if 8 to 16 units are connected in cascade: -10 to +45 °C +14 to +113 °F) Storage: -20 to +70 °C -4 to +158 °F
Ambient humidity	35 to 85 % RH, Storage: 35 to 85 % RH
Material	Enclosure: Polycarbonate, Metal plate: Aluminum
Weight	Net weight: 10 g approx., Gross weight: 25 g approx.

Designation	e-CON 8-channel connector input extension unit
Item / Model No.	SC-E81
Supply voltage	12 to 24 V DC ±10%
Current consumption	60 mA or less (with all indicators on) (Note 1)
Number of signals	8 inputs (Note 2)
Input	Connectable devices: NPN open-collector transistor output type sensors, switches, and other devices Current supply for input devices: 800 mA or less (total for 8 inputs) Input impedance: Approx. 17 kΩ
Output	NPN open-collector transistor • Maximum sink current: 50 mA • Applied voltage: 30 V DC or less (between output and 0 V) • Residual voltage: 1.5 V or less (with sink current of 50 mA)
Power indicator	Green LED (lights up when the power is ON)
Input indicator	8 green LEDs (light up when input is received from the corresponding channel)
Ambient temperature	-10 to +55 °C +14 to +131 °F (No dew condensation or icing allowed), (If 4 to 7 units are connected in cascade: -10 to +50 °C +14 to +122 °F , if 8 to 9 units are connected in cascade: -10 to +45 °C +14 to +113 °F) Storage: -20 to +70 °C -4 to +158 °F
Ambient humidity	35 to 85 % RH, Storage: 35 to 85 % RH
Material	Enclosure: Polycarbonate, Connector: Polyester
Weight	Net weight: 40 g approx., Gross weight: 85 g approx.

Notes: 1) Does not include current consumption or input current for connected input devices.
2) Uses eight channels of signaling, regardless of the number of connected input devices.

FIBER SENSORS

LASER SENSORS

PHOTO-ELECTRIC SENSORS

MICRO PHOTO-ELECTRIC SENSORS

AREA SENSORS

LIGHT CURTAINS / SAFETY COMPONENTS

PRESSURE / FLOW SENSORS

INDUCTIVE PROXIMITY SENSORS

PARTICULAR USE SENSORS

SENSOR OPTIONS

WIRE-SAVING UNITS

WIRE-SAVING SYSTEMS

MEASUREMENT SENSORS

STATIC ELECTRICITY PREVENTION DEVICES

LASER MARKERS

PLC

HUMAN MACHINE INTERFACES

ENERGY CONSUMPTION VISUALIZATION COMPONENTS

FA COMPONENTS

MACHINE VISION SYSTEMS

UV CURING SYSTEMS

Upper Communication Unit

ML Connector Plug-in

SC-GU3

SC-GU2-C

SC-GU1-485

SPECIFICATIONS

Designation	Analog voltage input unit	Analog current input unit
Item / Model No.	SC-A01	SC-A02
Supply voltage	12 to 24 V DC $\pm 10\%$ Ripple P-P 10% or less	12 to 24 V DC $\pm 10\%$ Ripple P-P 10% or less
Current consumption	25 mA or less (with all indicators on and 24 V applied) (Note 1)	25 mA or less (with all indicators on and 24 V applied) (Note 1)
Analog input	Voltage: 1 to 5 V DC (input impedance: approx. 200 k Ω)	Current: 4 to 20 mA DC (input impedance: approx. 250 k Ω)
Communication data (Note 2)	Analog \leftrightarrow communication data • Communication data: 0 to 4,000 digits (within range of 1 to 5 V) • Zero point: Within 0 digit $\pm 0.5\%$ F.S. • Span: Within 4,000 digits $\pm 0.5\%$ F.S. • Linearity: Within $\pm 0.5\%$ F.S.	Analog \leftrightarrow communication data • Communication data: 0 to 4,000 digits (within range of 4 to 20 mA) • Zero point: Within 0 digit $\pm 0.5\%$ F.S. • Span: Within 4,000 digits $\pm 0.5\%$ F.S. • Linearity: Within $\pm 0.5\%$ F.S.
Input	Connectable devices: NPN open-collector transistor output type Current supply for input devices: 100 mA or less Input impedance: Approx. 17 k Ω Operating voltage: On voltage of 17 V or more (between input and +V, 24 V applied) Off voltage of 4 V or less (between input and +V, 24 V applied)	Connectable devices: NPN open-collector transistor output type Current supply for input devices: 100 mA or less Input impedance: Approx. 17 k Ω Operating voltage: On voltage of 17 V or more (between input and +V, 24 V applied) Off voltage of 4 V or less (between input and +V, 24 V applied)
Output	NPN open-collector transistor • Maximum sink current: 50 mA or less (when expanding to 5 units or more, 25 mA) • Applied voltage: 30 V DC or less (between output and 0 V) • Residual voltage: 1.5 V or less (with sink current of 50 mA)	NPN open-collector transistor • Maximum sink current: 50 mA or less (when expanding to 5 units or more, 25 mA) • Applied voltage: 30 V DC or less (between output and 0 V) • Residual voltage: 1.5 V or less (with sink current of 50 mA)
Power indicator	Green LED (Lights up when the power is ON)	Green LED (Lights up when the power is ON)
Input indicator	Green LED (lights up when input is being received by unit)	Green LED (lights up when input is being received by unit)
Ambient temperature	-10 to +55 °C +14 to +131 °F (No dew condensation or icing allowed), (If 4 to 7 units are connected in cascade: -10 to +50 °C +14 to +122 °F, if 8 to 16 units are connected in cascade: -10 to +45 °C +14 to +113 °F) Storage: -20 to +70 °C -4 to +158 °F	-10 to +55 °C +14 to +131 °F (No dew condensation or icing allowed), (If 4 to 7 units are connected in cascade: -10 to +50 °C +14 to +122 °F, if 8 to 16 units are connected in cascade: -10 to +45 °C +14 to +113 °F) Storage: -20 to +70 °C -4 to +158 °F
Ambient humidity	35 to 85 % RH, Storage: 35 to 85 % RH	35 to 85 % RH, Storage: 35 to 85 % RH
Material	Case: Flame-resistant PBT, Connector: Polyester	Case: Flame-resistant PBT, Connector: Polyester
Weight	Net weight: 15 g approx., Gross weight: 40 g approx.	Net weight: 15 g approx., Gross weight: 40 g approx.
Accessory	Connector (e-CON): 1	Connector (e-CON): 1

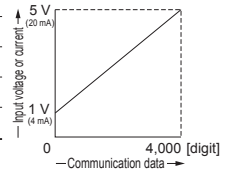

Notes: 1) Does not include current consumption or input current for connected input devices.
 2) The figure in the right illustrates the relationship between communication data and input voltage.

PRECAUTIONS FOR PROPER USE

Refer to p.1501 for general precautions.



- Never use this product in a device for personnel protection.
- In case of using sensing devices for personnel protection, use products which meet laws and standards, such as OSHA, ANSI or IEC etc., for personnel protection applicable in each region or country.

DIMENSIONS (Unit: mm in)

The CAD data in the dimensions can be downloaded from our website

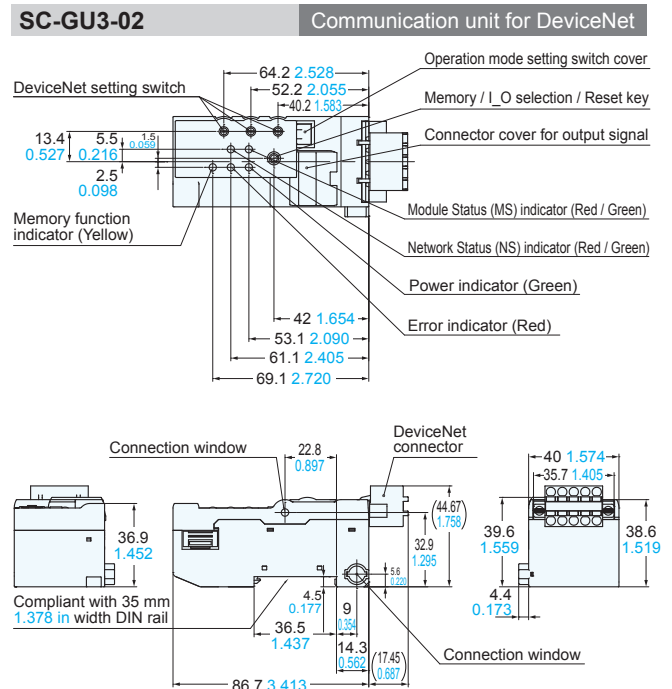
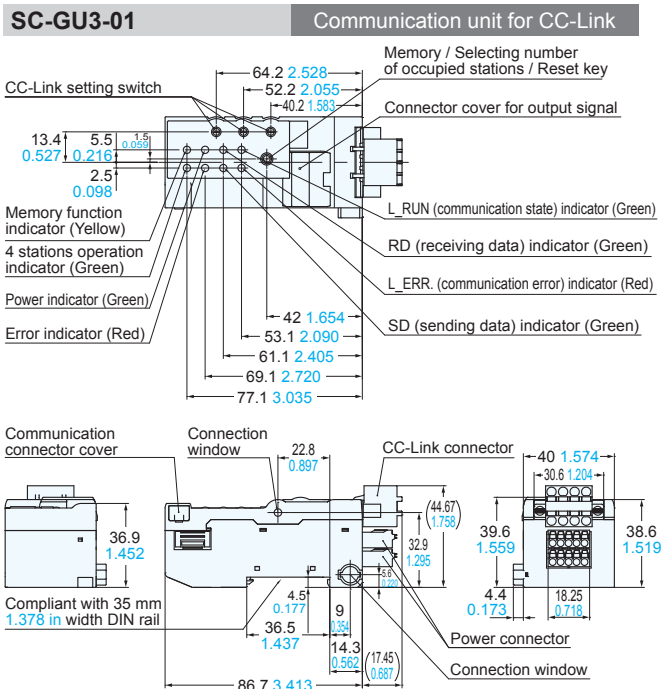

FIBER SENSORS
 LASER SENSORS
 PHOTO-ELECTRIC SENSORS
 MICRO PHOTO-ELECTRIC SENSORS
 AREA SENSORS
 LIGHT CURTAINS / SAFETY COMPONENTS
 PRESSURE / FLOW SENSORS
 INDUCTIVE PROXIMITY SENSORS
 PARTICULAR USE SENSORS
 SENSOR OPTIONS
 SIMPLE WIRE-SAVING UNITS
 WIRE-SAVING SYSTEMS
 MEASUREMENT SENSORS
 STATIC ELECTRICITY PREVENTION DEVICES
 LASER MARKERS
 PLC
 HUMAN MACHINE INTERFACES
 ENERGY CONSUMPTION VISUALIZATION COMPONENTS
 FA COMPONENTS
 MACHINE VISION SYSTEMS
 UV CURING SYSTEMS

DIMENSIONS (Unit: mm in)

The CAD data in the dimensions can be downloaded from our website

SC-GU3-03

Communication unit for EtherCAT

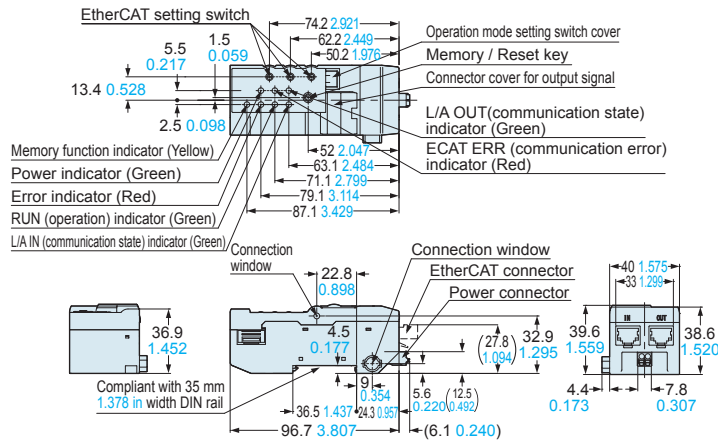

When an operation mode setting switch cover / a connector cover for output signal is removed

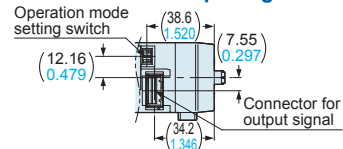

SC-GU3-EU

End unit

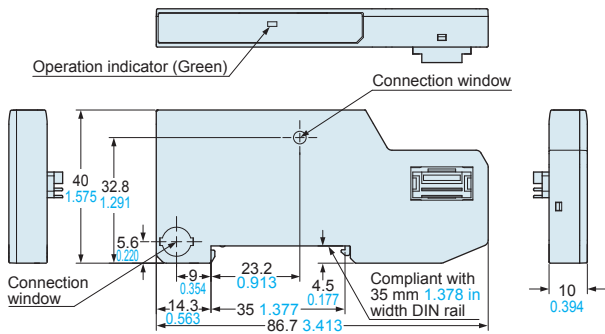

SC-71

Cascading connector unit

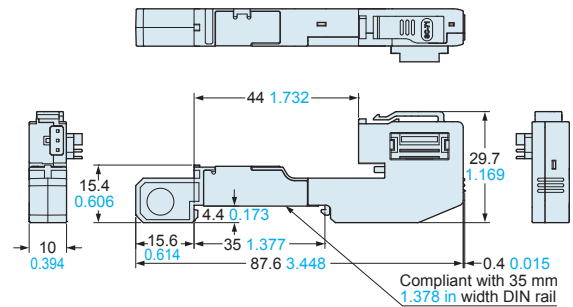

SC-E1

e-CON 1ch connector input extension unit

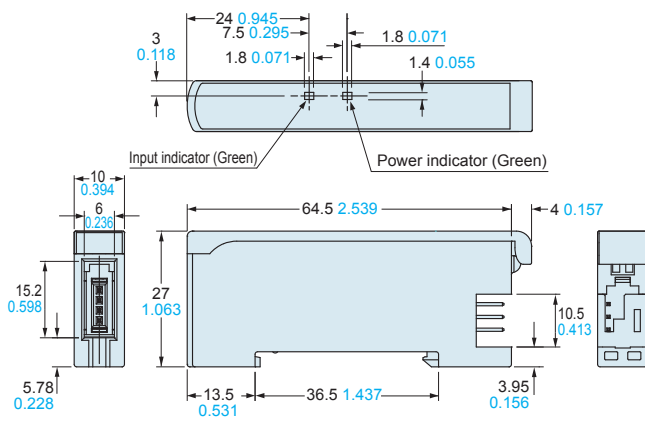

SC-E81 SC-E82

e-CON 8ch connector input extension unit

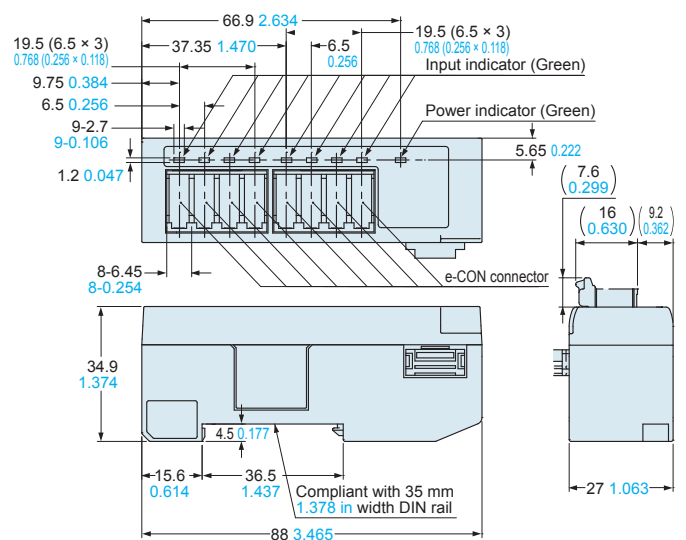

SC-A01 SC-A02

Analog input unit

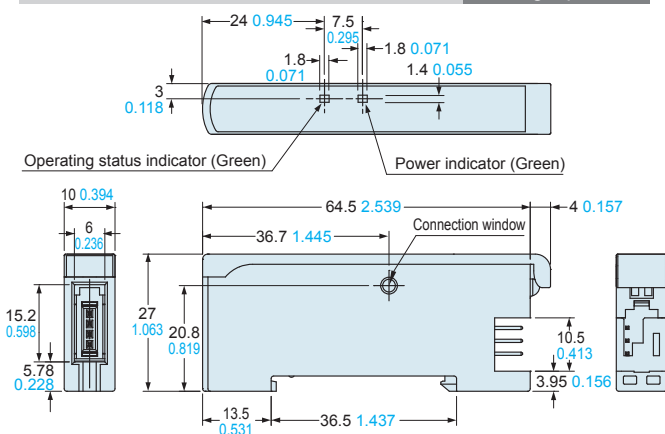

FIBER SENSORS

LASER SENSORS

PHOTO-ELECTRIC SENSORS

MICRO PHOTO-ELECTRIC SENSORS

AREA SENSORS

LIGHT CURTAINS / SAFETY COMPONENTS

PRESSURE / FLOW SENSORS

INDUCTIVE PROXIMITY SENSORS

PARTICULAR USE SENSORS

SENSOR OPTIONS

WIRE-SAVING UNITS

WIRE-SAVING SYSTEMS

MEASUREMENT SENSORS

STATIC ELECTRICITY PREVENTION DEVICES

LASER MARKERS

PLC

HUMAN MACHINE INTERFACES

ENERGY CONSUMPTION VISUALIZATION COMPONENTS

FA COMPONENTS

MACHINE VISION SYSTEMS

UV CURING SYSTEMS

Upper Communication Unit

MIL Connector Plug-in

SC-GU3

SC-GU2-C

SC-GU1-485