



Chipsmall Limited consists of a professional team with an average of over 10 year of expertise in the distribution of electronic components. Based in Hongkong, we have already established firm and mutual-benefit business relationships with customers from,Europe,America and south Asia,supplying obsolete and hard-to-find components to meet their specific needs.

With the principle of “Quality Parts,Customers Priority,Honest Operation,and Considerate Service”,our business mainly focus on the distribution of electronic components. Line cards we deal with include Microchip,ALPS,ROHM,Xilinx,Pulse,ON,Everlight and Freescale. Main products comprise IC,Modules,Potentiometer,IC Socket,Relay,Connector.Our parts cover such applications as commercial,industrial, and automotives areas.

We are looking forward to setting up business relationship with you and hope to provide you with the best service and solution. Let us make a better world for our industry!



Contact us

Tel: +86-755-8981 8866 Fax: +86-755-8427 6832

Email & Skype: info@chipsmall.com Web: www.chipsmall.com

Address: A1208, Overseas Decoration Building, #122 Zhenhua RD., Futian, Shenzhen, China



POWER MANAGEMENT

Features

- Single input charger with three charging modes
- Constant voltage — 4.2V, 1% regulation
- Fast-charge current regulation — 15% at 70mA, 9% at 700mA
- Charging by current regulation, voltage regulation, and thermal limiting
- Input voltage protection — 30V
- Current-limited adapter support capability — reduces power dissipation in charger IC
- USB high and low power modes limit charge current to prevent USB Vbus overload
- Instantaneous CC-to-CV transition for faster charging
- Programmable battery-dependent currents (adapter mode fast- and pre-charge, termination)
- Programmable source-limited currents (USB-high mode fast-charge, and USB-low mode fast- and pre-charge)
- Independent programming of termination current with dual-mode operation
- Three termination options — float-charge, automatic re-charge, or forced re-charge to keep the battery topped-off after termination without float-charging
- Soft-start reduces adapter or USB load transients
- High operating voltage range of SC811 permits use of unregulated adapters
- Complies with CCSA YD/T 1591-2006
- Space saving 2x2x0.6 (mm) MLPD package
- WEEE and RoHS compliant

Applications

- Mobile phones
- MP3 players
- GPS handheld receivers

Typical Application Circuit

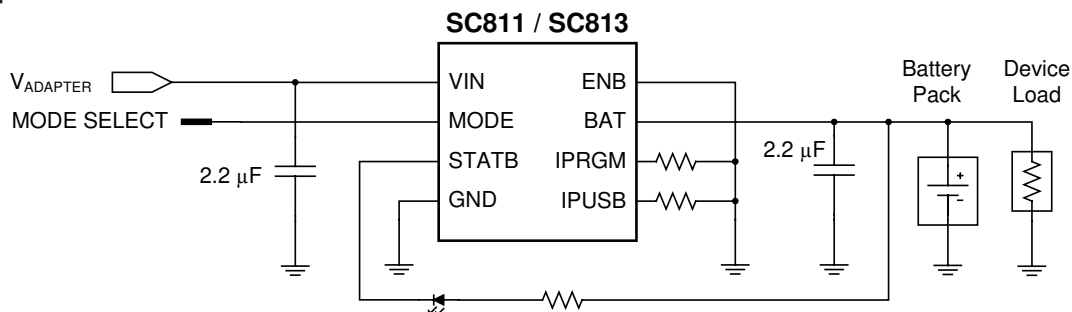

Description

The SC811 and SC813 are highly versatile single input triple mode (adapter/USB high current, USB low current) linear single-cell Li-ion battery chargers, each in an 8 lead 2x2 MLPD ultra-thin package. The input will survive sustained input voltage up to 30V to protect against hot plug overshoot and faulty charging adapters. The SC811 has 9.6V rising, 8.2V falling OVP thresholds for general purpose charging with low cost adaptors. The SC813 has 6V rising, 5.6V falling OVP thresholds for customers utilizing charging adapters with specifications that are similar to a USB Vbus supply. The SC811 and SC813 differ only in OVP threshold.

Charging begins automatically when an input source is applied to the charging input. Thermal limiting protects against excessive power dissipation. The charger can be programmed to turn off when charging is complete or to continue operating as an LDO regulator while float-charging the battery.

Three charging modes are provided: adapter mode, USB low power mode, and USB high power mode. Battery-capacity-dependent and charging source-dependent current programming are independently programmed. Adapter and USB high power modes can charge up to 1A, with the charging adapter operating either in voltage regulation or in current limit to obtain the lowest possible power dissipation. A single current programming pin is used to program pre-charge, termination, and adapter-mode fast-charge currents in fixed proportions. In the USB modes, a second programming pin is used to program low power pre-charge current and low and high power fast-charge currents. This configuration allows independent programming of termination current. The two USB modes dynamically limit the charging load if necessary to prevent overloading the USB Vbus supply.

Pin Configuration

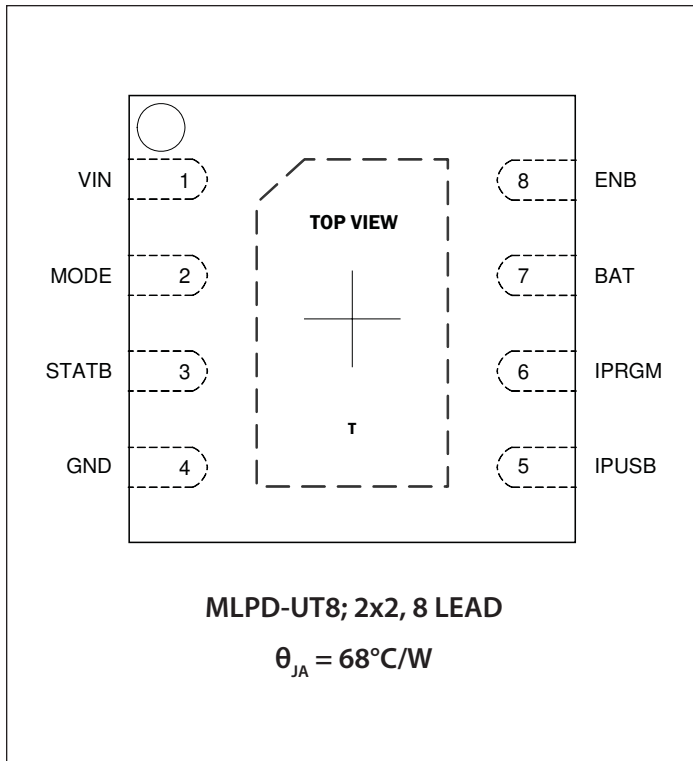

Ordering Information

Device	Package
SC811ULTRT ⁽¹⁾⁽²⁾	MLPD-UT-8 2x2
SC813ULTRT ⁽¹⁾⁽²⁾	MLPD-UT-8 2x2
SC811EVB	Evaluation Board
SC813EVB	Evaluation Board

Notes:

- (1) Available in tape and reel only. A reel contains 3,000 devices.
- (2) Lead-free package only. Device is WEEE and RoHS compliant.

Marking Information

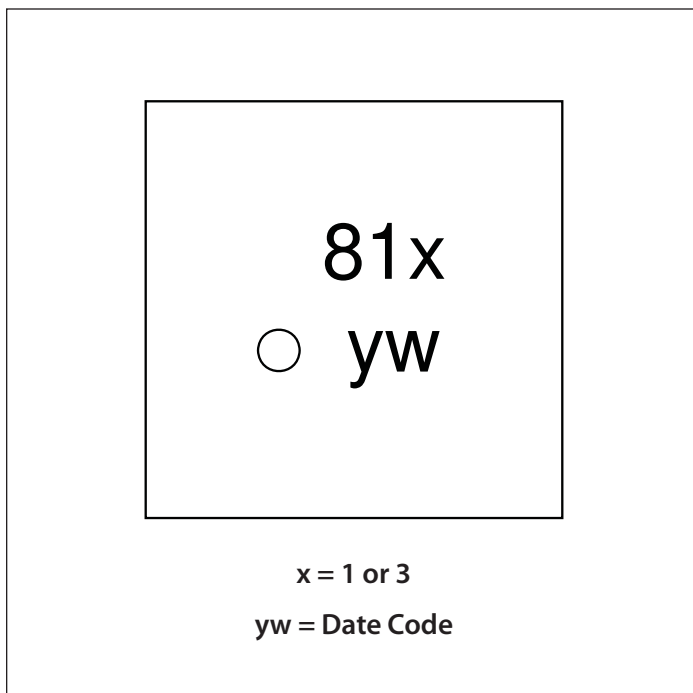

Absolute Maximum Ratings

VIN (V).....	-0.3 to +30.0
BAT, IPRGM, IPUSB (V).....	-0.3 to +6.5
STATB, ENB, MODE (V).....	-0.3 to $V_{BAT} + 0.3$
VIN Input Current (A).....	1.5
Total Power Dissipation (W).....	2
BAT, IPRGM, IPUSB Short to GND Duration....	Continuous
ESD Protection Level ⁽¹⁾ (kV).....	2

Recommended Operating Conditions

Operating Ambient Temperature (°C).....	-40 to +85
SC811:	
VIN Adapter Mode Operating Voltage ⁽²⁾ (V)...	4.60 to 8.20
VIN USB Modes Operating Voltage ⁽²⁾ (V).....	4.35 to 8.20
SC813:	
VIN Adapter Mode Operating Voltage ⁽²⁾ (V)...	4.60 to 5.60
VIN USB Modes Operating Voltage ⁽²⁾ (V).....	4.35 to 5.60

Thermal Information

Thermal Resistance, Junction to Ambient ⁽³⁾ (°C/W).....	68
Junction Temperature Range (°C).....	+150
Storage Temperature Range (°C).....	-65 to +150
Peak IR Reflow Temperature (°C).....	+260

Exceeding the above specifications may result in permanent damage to the device or device malfunction. Operation outside of the parameters specified in the Electrical Characteristics section is not recommended.

NOTES:

- (1) Tested according to JEDEC standard JESD22-A114-B.
- (2) This is the input voltage at which the charger is guaranteed to begin operation. Maximum operating voltage is the maximum V_{supply} as defined in EIA/JEDEC Standard No. 78, paragraph 2.11.
- (3) Calculated from package in still air, mounted to 3 x 4.5 (in), 4 layer FR4 PCB with thermal vias under the exposed pad per JESD51 standards.

Electrical Characteristics

Test Conditions: $V_{VIN} = 4.75V$ to $5.25V$; $V_{BAT} = 3.7V$; Typ values at 25°C; Min and Max at $-40^{\circ}C < T_A < 85^{\circ}C$, unless specified.

Parameter	Symbol	Conditions	Min	Typ	Max	Units
VIN Adapter Mode Rising Threshold	$VT_{ADUVLO-R}$		4.30	4.45	4.60	V
VIN Adapter Mode Falling Threshold ⁽¹⁾	$VT_{ADUVLO-F}$	$V_{VIN} > V_{BAT}$	2.70	2.85	3.00	V
VIN USB Modes Rising Threshold	$VT_{USBVLO-R}$	$V_{VIN} > V_{BAT}$		4.20	4.35	V
VIN USB Modes Falling Threshold	$VT_{USBVLO-F}$	$V_{VIN} > V_{BAT}$	3.65	4.00		V
VIN USB Modes Hysteresis	$VT_{USBVLO-H}$	$VT_{USBVLO-R} - VT_{USBVLO-F}$	100			mV
VIN OVP Rising Threshold	VT_{OVP-R}	All modes, SC811		9.0	9.6	V
		All modes, SC813		5.85	6.0	
VIN OVP Falling Threshold	VT_{OVP-F}	All modes, SC811	8.2	8.8		V
		All modes, SC813	5.6	5.75		
VIN OVP Hysteresis	VT_{OVP-H}	$VT_{OVP-R} - VT_{OVP-F}$, all modes, SC811	50	200		mV
		$VT_{OVP-R} - VT_{OVP-F}$, all modes, SC813	50	100		

Electrical Characteristics (continued)

Parameter	Symbol	Conditions	Min	Typ	Max	Units
VIN Charging Disabled Quiescent Current	$I_{q_{VIN_DIS}}$	$V_{ENB} = V_{BAT}$		2	3	mA
VIN Charging Enabled Quiescent Current	$I_{q_{VIN_EN}}$	$V_{ENB} = 0V$, excluding I_{BAT} , I_{IPRGM} and I_{IPUSB}		2	3	mA
CV Regulation Voltage	V_{CV}	$I_{BAT} = 50mA$, $-40^{\circ}C \leq T_J \leq 125^{\circ}C$	4.16	4.20	4.24	V
CV Voltage Load Regulation	V_{CV_LOAD}	Relative to V_{CV} @ 50mA, $1mA \leq I_{BAT} \leq 1A$, $-40^{\circ}C \leq T_J \leq 125^{\circ}C$	-20		10	mV
Re-charge Threshold	$V_{T_{ReQ}}$	$V_{CV} - V_{BAT}$	60	100	140	mV
Pre-charge Threshold (rising)	$V_{T_{PreQ}}$		2.85	2.90	2.95	V
Battery Leakage Current	I_{BAT_VO}	$V_{BAT} = V_{CV}$, $V_{VIN} = 0V$		0.1	1	μA
	I_{BAT_DIS}	$V_{BAT} = V_{CV}$, $V_{VIN} = 5V$, $V_{ENB} = 2V$		0.1	1	μA
	I_{BAT_MON}	$V_{BAT} = V_{CV}$, $V_{VIN} = 5V$; ENB not connected		0.1	1	μA
IPRGM Programming Resistor	R_{IPRGM}		2.05		29.4	k Ω
Fast-Charge Current, Adapter Mode	I_{FQ_AD}	$R_{IPRGM} = 2.94k\Omega$, $V_{T_{PreQ}} < V_{BAT} < V_{CV}$	643	694	745	mA
Pre-Charge Current, Adapter Mode and USB High Power Mode	I_{PreQ_AD}	$R_{IPRGM} = 2.94k\Omega$, $1.8V < V_{BAT} < V_{T_{PreQ}}$	105	139	173	mA
Termination Current, Any Mode	I_{TERM}	$R_{IPRGM} = 2.94k\Omega$, $V_{BAT} = V_{CV}$	59	69	80	mA
IPUSB Programming Resistor	R_{IPUSB}		2.05		29.4	k Ω
Fast-Charge Current, USB High Power Mode	I_{FQ_USB}	$R_{IPUSB} = 4.42k\Omega$, $1.8V < V_{BAT} < V_{T_{PreQ}}$	427	462	497	mA
Pre-Charge Current and Fast-Charge Current, USB Low Power Mode	I_{PreQ_USB}	$R_{IPUSB} = 4.42k\Omega$, $1.8V < V_{BAT} < V_{CV}$	69	92	116	mA
Dropout Voltage	V_{DO}	$I_{BAT} = 700mA$, $0^{\circ}C \leq T_J \leq 125^{\circ}C$		0.40	0.60	V
IPRGM Fast-charge Regulated Voltage	V_{IPRGM_FQ}	$V_{VIN} = 5.0V$, $V_{T_{PreQ}} < V_{BAT} < V_{CV}$		2.04		V
IPRGM Pre-charge Regulated Voltage	V_{IPRGM_PQ}	$1.8V < V_{BAT} < V_{T_{PreQ}}$		0.408		V
IPRGM Termination Threshold Voltage	$V_{T_{IPRGM_TERM}}$	$V_{BAT} = V_{CV}$ (either input selected)		0.204		V
IPUSB Fast-charge Regulated Voltage	V_{IPUSB_FQ}	$V_{VIN} = 0V$, $V_{T_{PreQ}} < V_{BAT} < V_{CV}$		2.04		V
IPUSB Pre-charge or USB Low Power Mode Regulated Voltage	V_{IPUSB_PQ}	$V_{VIN} = 0V$, $V_{BAT} < V_{T_{PreQ}}$		0.408		V
VIN USB Modes Under-Voltage Load Regulation Limiting Voltage	V_{UVLR}	$5mA \leq VIN$ supply current limit \leq 500mA, $V_{MODE} = 2V$, $R_{IPUSB} = 3.65k\Omega$ (559mA)	4.45	4.58	4.70	V

Electrical Characteristics (continued)

Parameter	Symbol	Conditions	Min	Typ	Max	Units
Thermal Limiting Threshold Temperature	T_{TL}			130		°C
Thermal Limiting Rate	i_T			50		mA/°C
ENB or MODE Input High Voltage Threshold	V_{IH}		1.6			V
ENB or MODE Input Mid Voltage Range	V_{IM}		0.7		1.3	V
ENB or MODE Input Low Voltage Threshold	V_{IL}				0.3	V
ENB Input High-range Threshold Input Current	$I_{ENB_IH_TH}$	ENB current required to pull ENB from floating midrange into high range		23	50	μA
ENB Input High-range Sustain Input Current	$I_{ENB_IH_SUS}$	Current required to hold ENB in high range, $Min V_{IH} \leq V_{ENB} \leq V_{BAT}$ $Min V_{IH} \leq V_{BAT} \leq 4.2V$		0.3	1	μA
MODE Input High-range Input Current	I_{MODE_IH}	$V_{MODE} = Min V_{IH}$		23	75	μA
ENB or MODE Input Mid-range Load Limit	I_{IM}	Input will float to mid range when this load limit is observed.	-5		5	μA
ENB or MODE Input Low-range Input Current	I_{IL}	$0V \leq (V_{ENB} \text{ or } V_{MODE}) \leq Max V_{IL}$	-25	12		μA
MODE Input Monitor State Input Current	I_{MODE_MON}	$V_{MODE} = V_{BAT} = 4.2V$, $V_{ENB} = 1V$ and Charging Terminated			1	μA
ENB or MODE Input Leakage	I_{ILEAK}	$V_{VIN} = 0V$ or $V_{VIN} = 5V$, V_{ENB} and $V_{MODE} = V_{BAT} = 4.2V$			1	μA
STATB Output Low Voltage	V_{STAT_LO}	$I_{STAT_SINK} = 2mA$			0.5	V
STATB Output High Current	I_{STAT_HI}	$V_{STAT} = 5V$			1	μA

Notes:

- (1) Sustained operation to $V_{ADUVLO-F} \leq V_{VIN}$ is guaranteed only if a current limited charging source applied to VIN is pulled below $V_{ADUVLO-R}$ by the charging load; forced VIN voltage below $V_{ADUVLO-R}$ may in some cases result in regulation errors or other unexpected behavior.

Typical Characteristics

CV Line Regulation

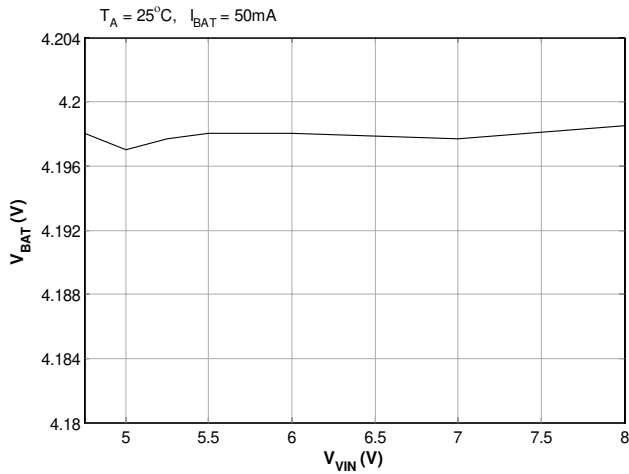

CV Load Regulation

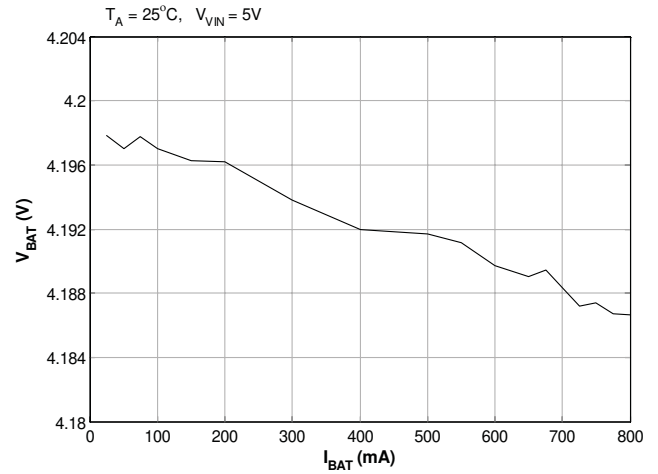

CV Temperature Regulation

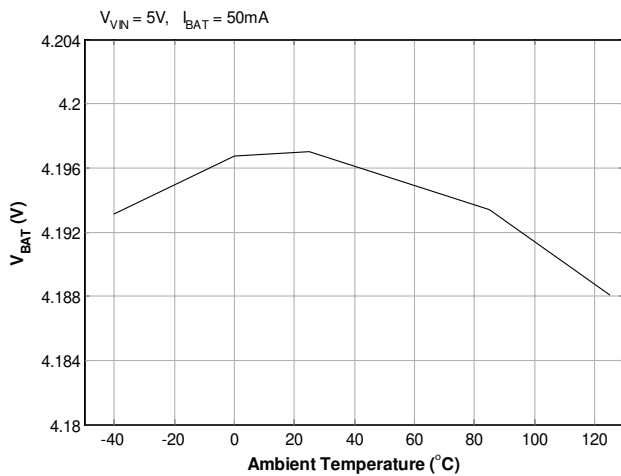

CC AD or USB High FQ Line Regulation

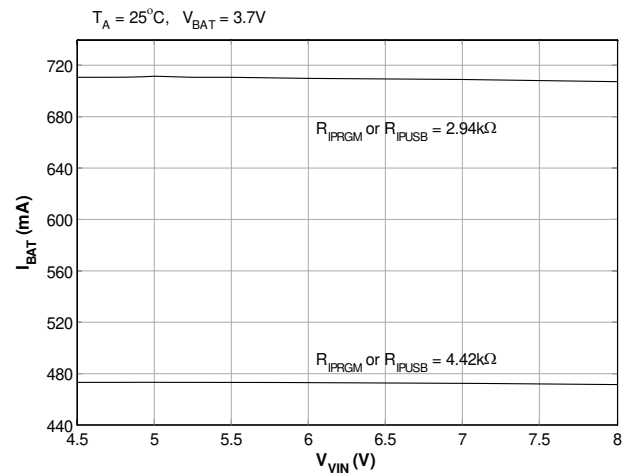

CC AD or USB High FQ V_{BAT} Regulation

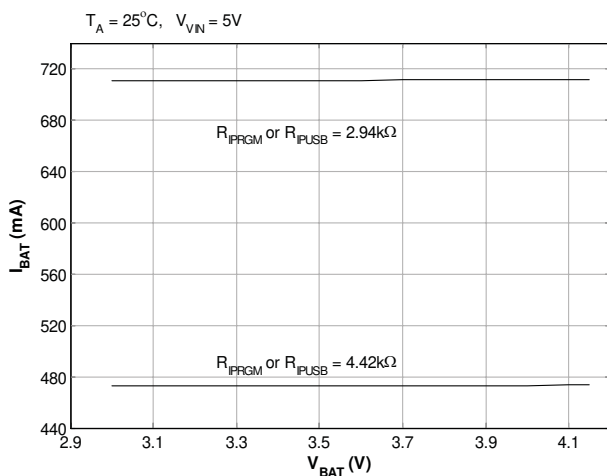

CC AD or USB High FQ Temperature Regulation

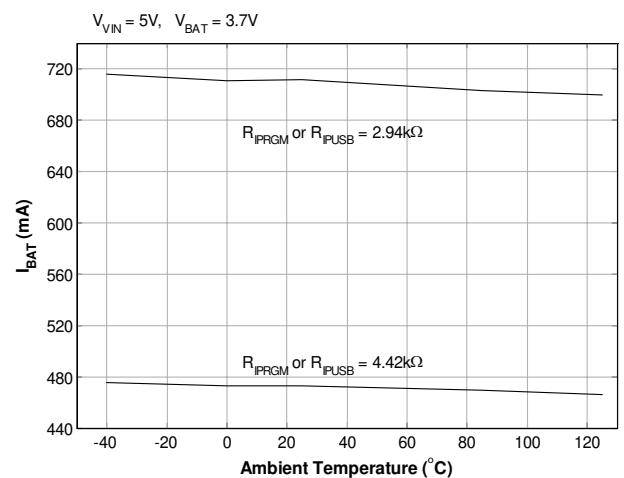

Typical Characteristics

CC PQ Line Regulation

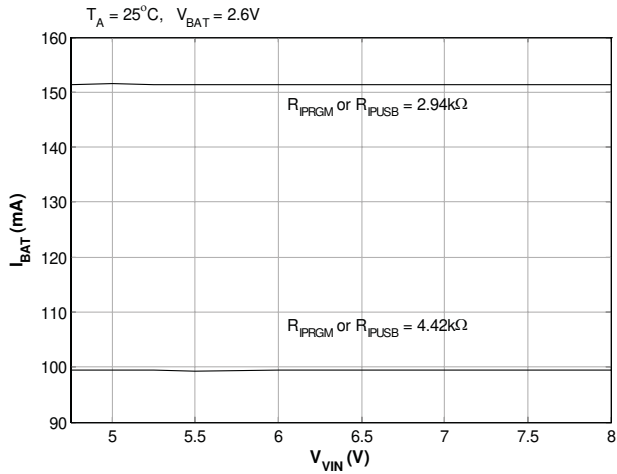

CC PQ Temperature Regulation

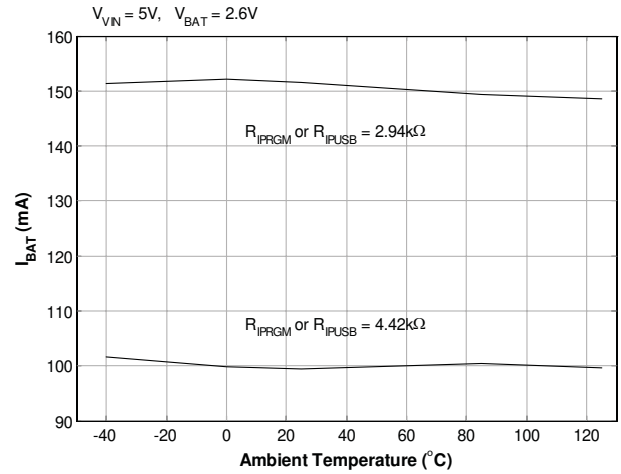

CC USB Low Power FQ Line Regulation

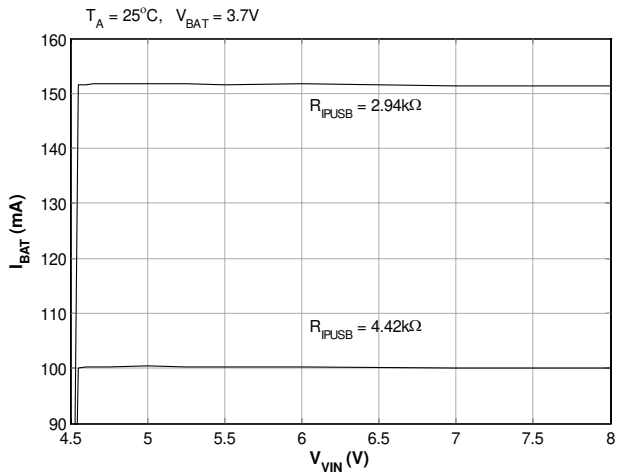

CC USB Low Power FQ V_{BAT} Regulation

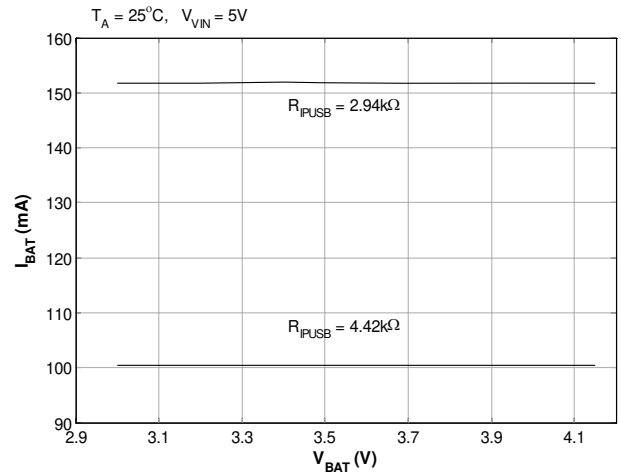

CC USB Low Power FQ Temperature Regulation

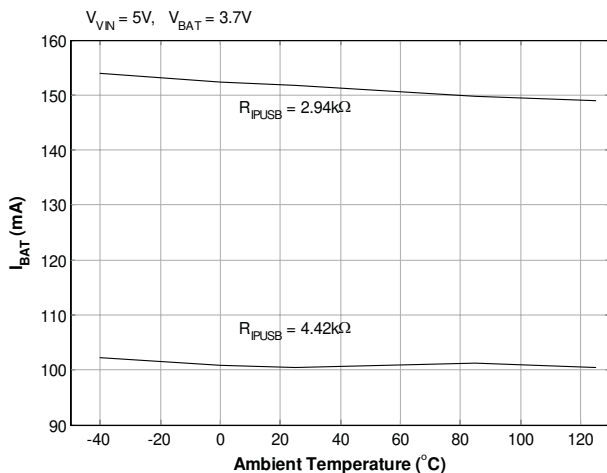

Typical Characteristics

I_{FQ_AD} vs. R_{IPRGM} or I_{FQ_USB} High Power vs. R_{IPUSB}

$V_{VIN} = 5V, V_{BAT} = 3.7V, T_A = 25^\circ C$

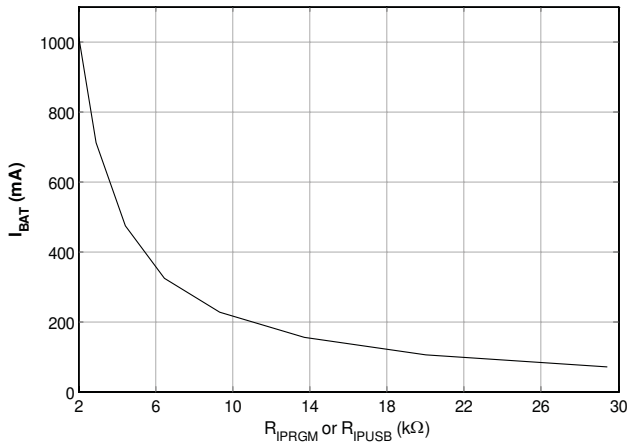

I_{PQ_AD} or I_{PQ_USB} vs. R_{IPRGM} or I_{FQ_USB} Low Power vs. R_{IPUSB}

$V_{VIN} = 5V, V_{BAT} = 2.6V, T_A = 25^\circ C$

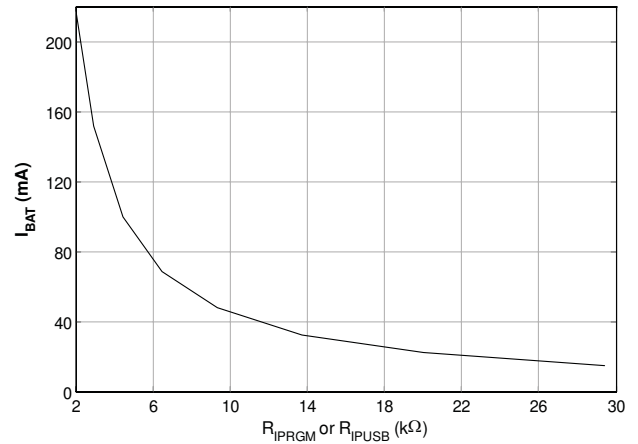

Charging Cycle Battery Voltage and Current

850mAhr battery, $R_{IPRGM} = 2.94k\Omega, V_{VIN} = 5.0V, T_A = 25^\circ C$

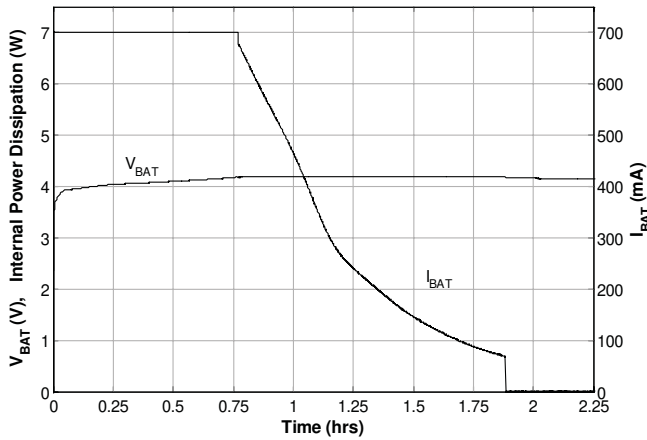

Pre-Charging Battery Voltage and Current

850mAhr battery, $R_{IPRGM} = 2.94k\Omega, V_{VIN} = 5.0V, T_A = 25^\circ C$

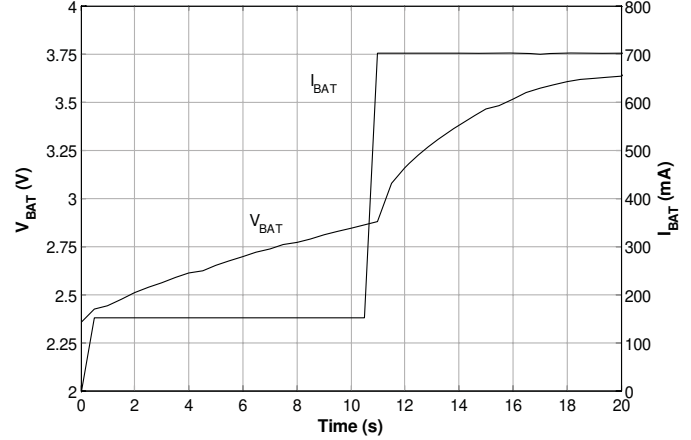

CC-to-CV Battery Voltage and Current

850mAhr battery, $R_{IPRGM} = 2.94k\Omega, V_{VIN} = 5.0V, T_A = 25^\circ C$

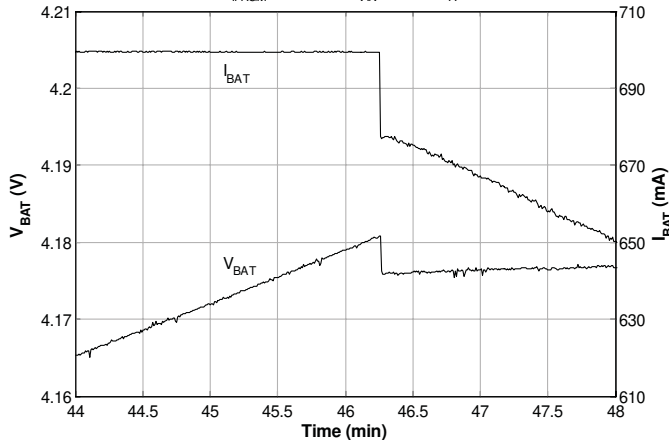

Re-Charge Cycle Battery Voltage and Current

850mAhr battery, $R_{IPRGM} = 2.94k\Omega, V_{VIN} = 5.0V, Load = 10mA$

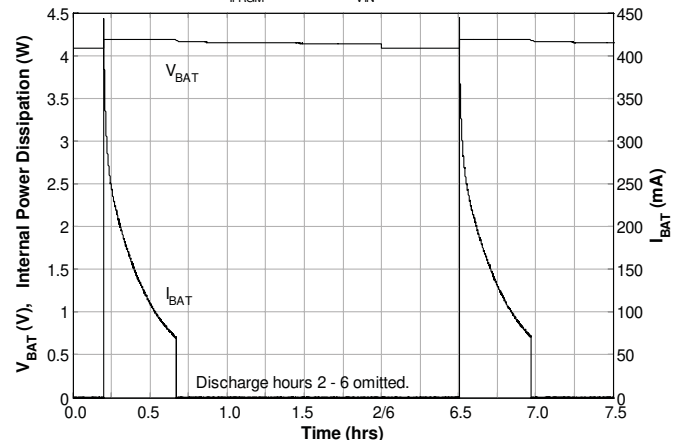

Typical Characteristics

Mode Reselection — USB Low to USB High

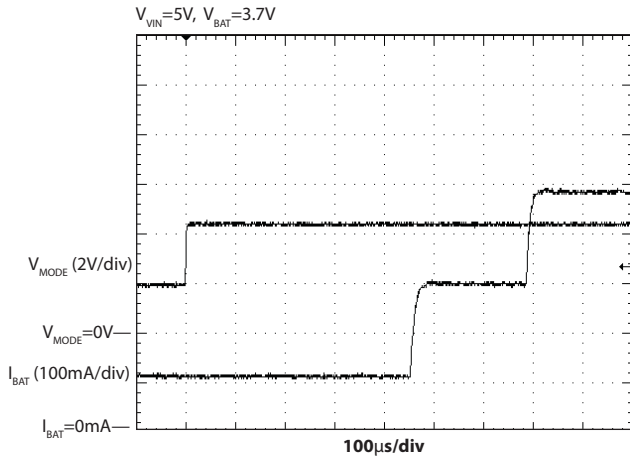

Mode Reselection — USB High to USB Low

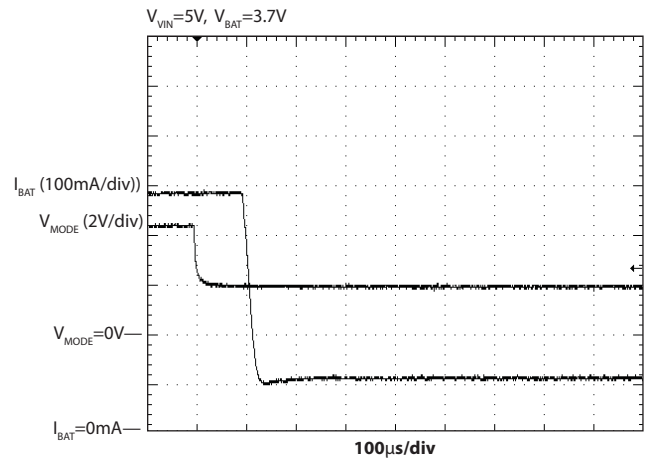

Mode Reselection — AD to USB High

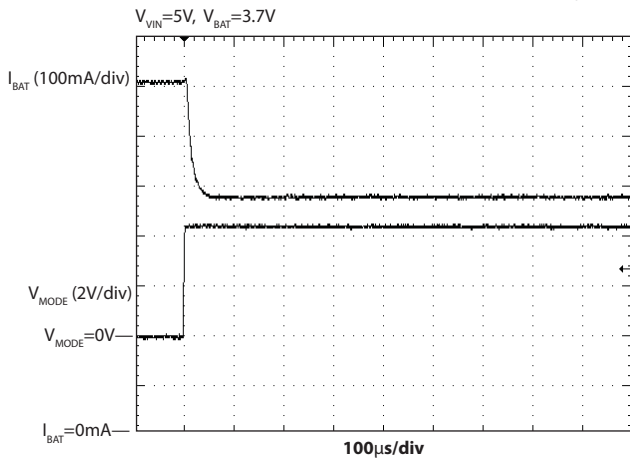

Mode Reselection — USB High to AD

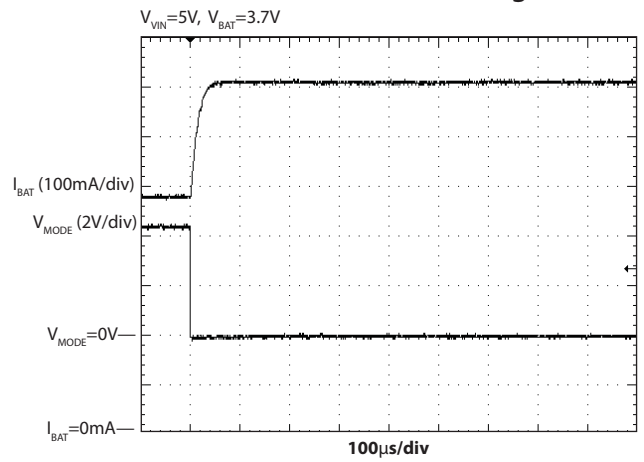

Mode Reselection — AD to USB Low

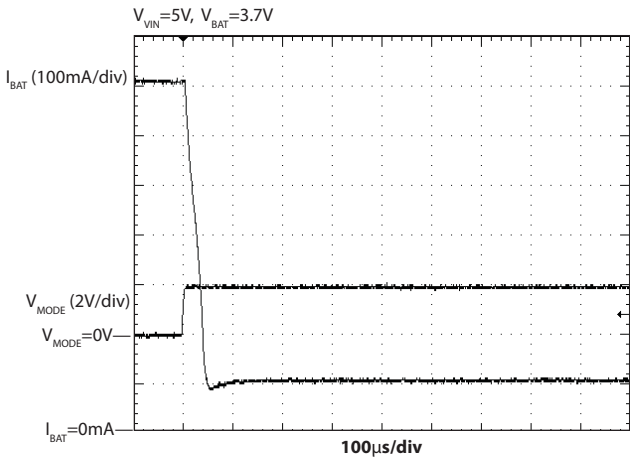

Mode Reselection — USB Low to AD

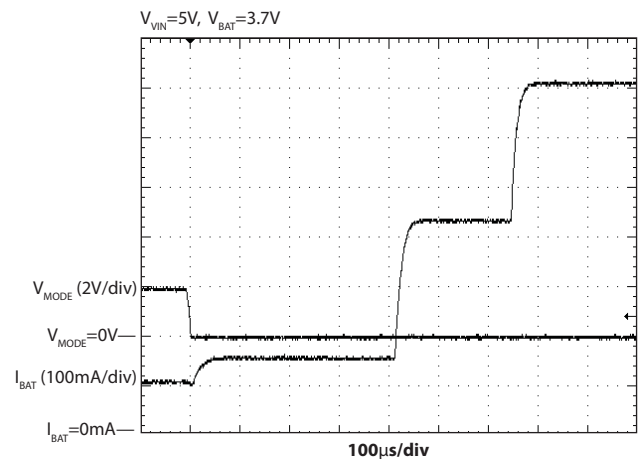

Pin Descriptions

Pin #	Pin Name	Pin Function
1	VIN	Supply pin — connect to charging adapter (wall adapter or USB). This pin is protected against damage due to high voltage up to 30V.
2	MODE	Charging mode selection (tri-level logical) input — Logical high selects USB high power mode, floating selects USB low power mode, ground selects adapter mode.
3	STATB	Status output pin — This open-drain pin is asserted (pulled low) when a valid charging supply is connected to the VIN pin, and a charging cycle begins. It is released when the termination current is reached, indicating that charging is complete. STATB is not asserted for re-charge cycles.
4	GND	Ground
5	IPUSB	Fast-charge and pre-charge current programming pin for a USB mode charging source — USB high power mode (100%) and low power mode (20%) fast-charge current are programmed by connecting a resistor from this pin to ground. USB low power mode pre-charge current is equal to the low power mode fast-charge current (20% of USB high power mode fast-charge current).
6	IPRGM	Adapter mode fast-charge, adapter and USB high power modes pre-charge, and all modes termination current programming pin — Connect a resistor from this pin to ground. Pre-charge current is 20% of IPRGM-programmed adapter mode fast-charge current when in adapter mode or USB high power mode. The charging termination current threshold (for adapter or either USB mode selection) is 10% of the IPRGM programmed fast-charge current.
7	BAT	Charger output — connect to battery positive terminal.
8	ENB	Combined device enable/disable — Logic high disables the device. Tie to GND to enable charging with indefinite float-charging. Float this pin to enable charging without float-charge upon termination. Note that this pin must be grounded if the SC811/3 is to be operated without a battery connected to BAT.
T	Thermal Pad	Pad is for heatsinking purposes — not connected internally. Connect exposed pad to ground plane using multiple vias.

Block Diagram

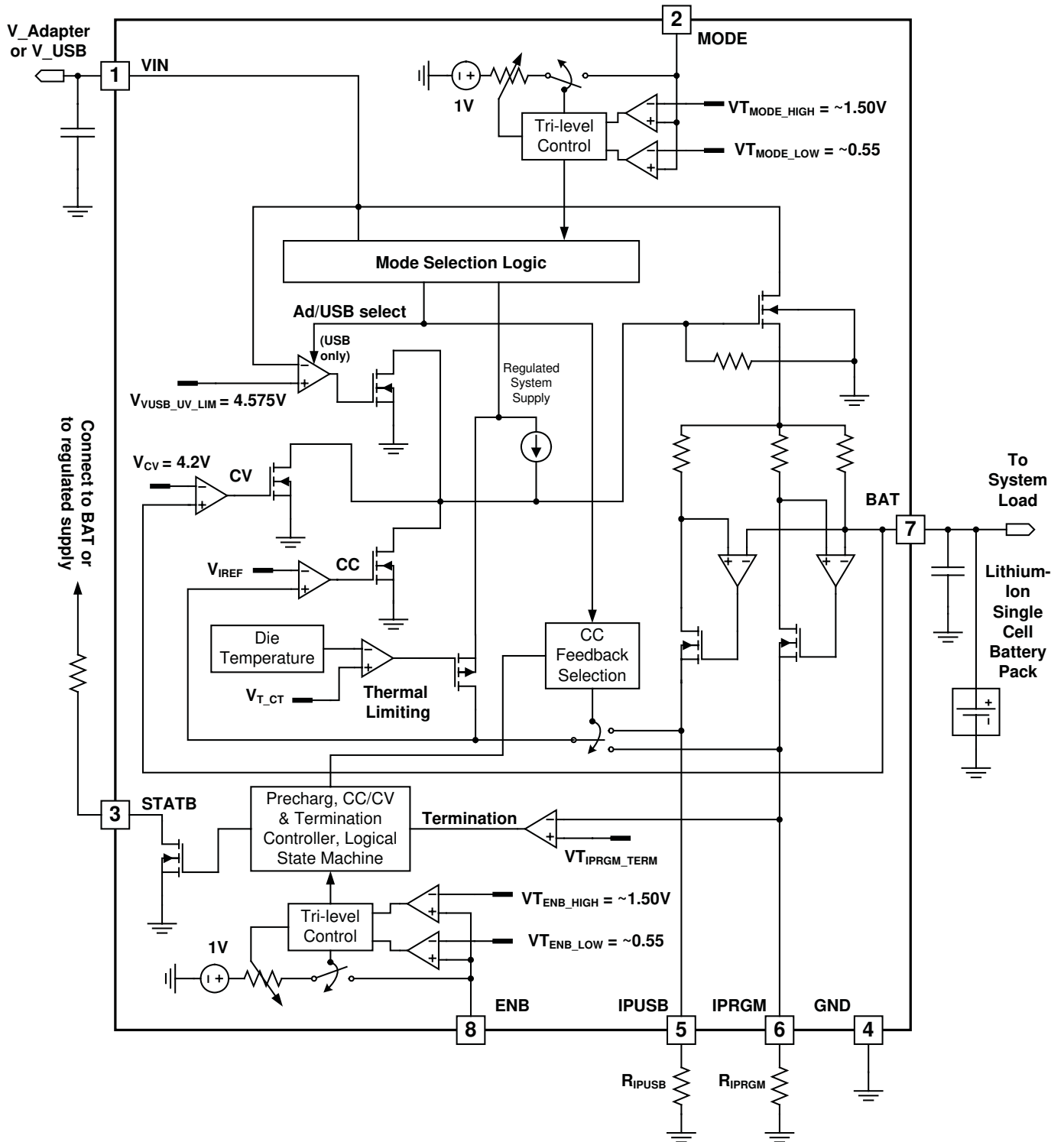

Applications Information

Charger Operation

The SC811/3 is a single input tri-mode stand-alone Li-ion battery charger. (The SC811 differs from the SC813 only in the input voltage Over Voltage Protection threshold.) It provides selections of adapter mode and USB high and low power mode charging. The device is independently programmed for battery capacity dependent currents (adapter fast-charge current and termination current) using the IPRGM pin. Charging currents from the USB Vbus supply, which has a maximum load specification, are programmed using the IPUSB pin when either of the USB modes is selected.

When an input supply is first detected, a charge cycle is initiated and the STATB open-drain output goes low. If the battery voltage is less than the pre-charge threshold voltage, the pre-charge current is supplied. Pre-charge current is 20% of the IPRGM (adapter or USB high power modes) or IPUSB (USB low power mode) programmed fast-charge current.

When the battery voltage exceeds the pre-charge threshold, typically within seconds for a standard battery with a starting cell voltage greater than 2V, the fast-charge Constant Current (CC) mode begins. The charge current soft-starts in three steps (20%, 60%, and 100% of programmed fast-charge current) to reduce adapter load transients. CC current is programmed by the IPRGM resistance to ground when adapter mode is selected and by the IPUSB resistance to ground when either USB mode is selected. In USB low power mode, the CC current is held at 20% of the IPUSB programmed fast-charge current.

The charger begins Constant Voltage (CV) regulation when the battery voltage rises to the fully-charged single-cell Li-ion regulation voltage (V_{CV}), nominally 4.2V. In CV regulation, the output voltage is regulated, and as the battery charges, the charge current gradually decreases. The STATB output goes high when I_{BAT} drops below the termination threshold current, which is 10% of the IPRGM pin programmed fast-charge current regardless of the mode selected. This is known as charge termination.

Optional Float-charging or Monitoring

Depending on the state of the ENB input, upon termination the SC811/3 either operates indefinitely as a voltage regulator (known as float-charging) or it turns off its

output. If the output is turned off upon termination, the device enters the monitor state. In this state, the output remains off until the BAT pin voltage decreases by the re-charge threshold ($V_{T_{ReQ}}$). A re-charge cycle then begins automatically and the process repeats. A forced re-charge cycle can also be periodically commanded by the processor to keep the battery topped-off without float-charging. See the Monitor State section for details. Re-charge cycles are not indicated by the STATB pin.

Charging Input Pin Mode Dependencies

The UVLO rising and falling thresholds are adjusted with the charging mode selected. In adapter mode, if the charging current loads the adapter beyond its current limit, the input voltage will be pulled down to just above the battery voltage. The adapter mode UVLO falling threshold is set close to the battery voltage pre-charge threshold to permit low-dissipation charging from a current limited adapter.

The USB modes provide a higher UVLO falling threshold applicable to the USB specification. The USB modes also provide Under-Voltage Load Regulation (UVLR), in which the charging current is reduced if needed to prevent overloading of the USB Vbus supply. UVLR can serve as a low-cost alternative to directly programming the USB low power charge current. This can be beneficial for charging small batteries, for which the USB high power fast-charge current must be programmed to less than 500mA. The fixed 20% USB low power mode fast-charge current would be less than 100mA and, therefore, is unsuitable for minimum charge-time applications. UVLR can also be used where there is no signal available to indicate whether USB low or high power mode should be selected.

All modes use the same input Over-Voltage Protection (OVP) threshold as defined in the Electrical Characteristics section for the device being used.

Constant Current Mode Fast-charge Current Programming

Constant Current (CC) regulation is active when the battery voltage is above $V_{T_{PreQ}}$ and less than V_{CV} . When adapter mode is selected, the programmed CC regulation fast-charge (FQ) current is inversely proportional to

Applications Information (continued)

the resistance between IPRGM and GND according to the equation

$$I_{FQ_AD} = \frac{V_{IPRGM_Typ}}{R_{IPRGM}} \times 1000$$

When either of the USB modes is selected, the programmed CC regulation fast-charge current is inversely proportional to the resistance between IPUSB and GND according to the equation

$$I_{FQ_USB} = \frac{V_{IPUSB_Typ}}{R_{IPUSB}} \times 1000$$

The fast-charge current can be programmed for a minimum of 70mA and a maximum of 995mA for either adapter or USB high power mode. This range for both modes permits the use of USB high power mode for general purpose adapter charging, allowing fully independent programming of termination current. (See the application sections, Independent Programming of Termination Current, and USB-only Charging of Very Large Batteries.)

Current regulation accuracy is dominated by gain error at high current settings, and offset error at low current settings. The range of expected fast-charge output current versus programming resistance R_{IPRGM} or R_{IPUSB} (for adapter or USB high power mode, respectively) is shown in Figures

1a and 1b. Each figure shows the nominal fast-charge current versus nominal R_{IPRGM} or R_{IPUSB} resistance as the center plot, and two theoretical limit plots indicating maximum and minimum current versus nominal programming resistance. These plots are derived from models of the expected worst-case contribution of error sources depending on programmed current. The current range includes the uncertainty due to 1% tolerance resistors. The dots on each plot indicate the currents obtained with standard value 1% tolerance resistors. Figures 1a and 1b show low and high resistance ranges, respectively. The USB low power mode fast-charge current accuracy is exactly like that of pre-charge in high power mode. USB low power mode current regulation accuracy is addressed in the next section.

Pre-charge and USB Low Power Mode Fast-charge Current Regulation

Pre-charging is automatically selected when the battery voltage is below the pre-charge threshold voltage ($V_{T_{PreQ}}$), typically 2.8V. Pre-charge current conditions the battery for fast charging. The pre-charge current value is fixed at 20% nominally of the fast-charge current. It is programmed by the resistance between IPRGM and GND for adapter mode and USB high power mode, and by the resistance between IPUSB and GND for USB low power mode. Note that USB low power mode pre-charge current is equal to USB low power mode fast-charge current.

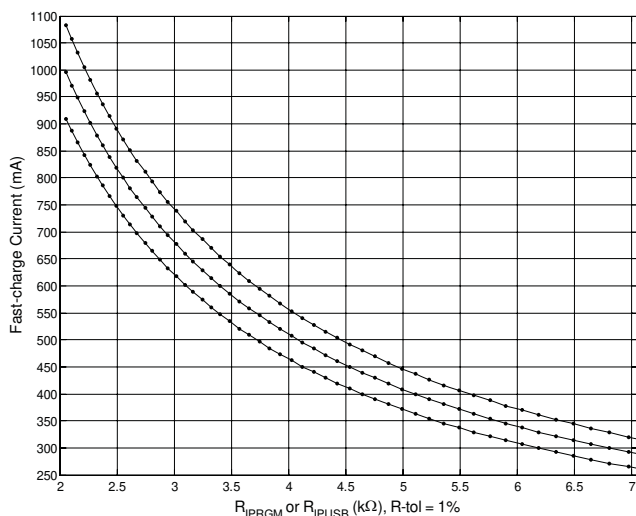

Figure 1a — Fast-charge Current Tolerance versus Programming Resistance, Low Resistance Range

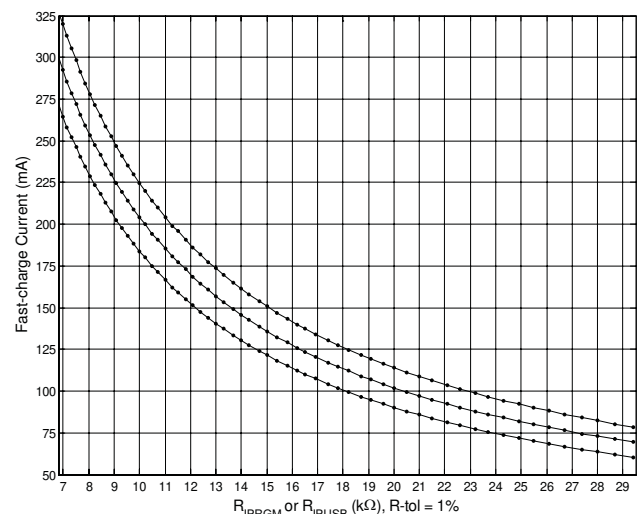

Figure 1b — Fast-charge Current Tolerance versus Programming Resistance, High Resistance Range

Applications Information (continued)

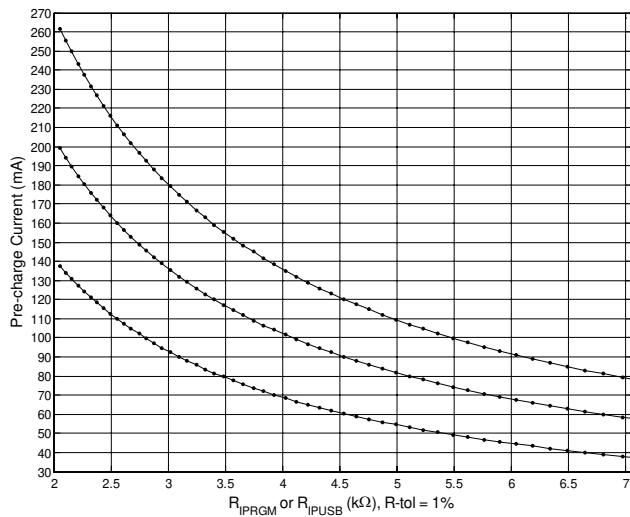

Figure 2a — Pre-charge Current and USB Low Power Mode Fast-charge Current Tolerance vs. Programming Resistance, Low Resistance Range

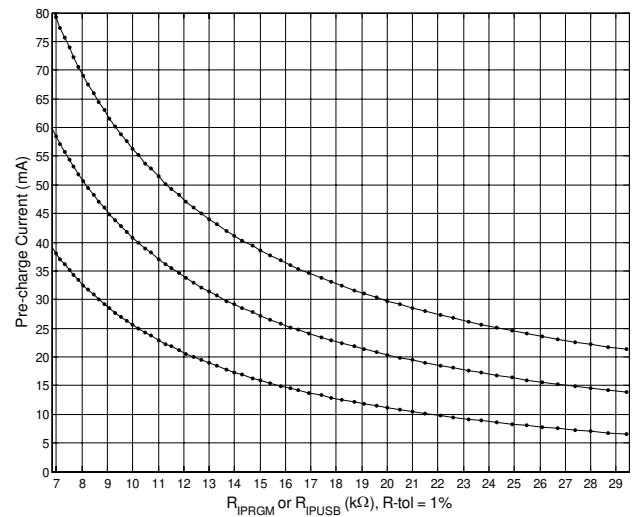

Figure 2b — Pre-charge Current and USB Low Power Mode Fast-charge Current Tolerance vs. Programming Resistance, High Resistance Range

Pre-charge current regulation accuracy is dominated by offset error. The range of expected pre-charge output current versus programming resistance R_{IPRGM} or R_{IPUSB} is shown in Figures 2a and 2b. Each figure shows the nominal pre-charge current versus nominal R_{IPRGM} or R_{IPUSB} resistance as the center plot and two theoretical limit plots indicating maximum and minimum current versus nominal programming resistance. These plots are derived from models of the expected worst-case contribution of error sources depending on programmed current. The current range includes the uncertainty due to 1% tolerance resistors. The dots on each plot indicate the currents obtained with standard value 1% tolerance resistors. Figures 2a and 2b show low and high resistance ranges, respectively.

Termination

When the battery voltage reaches V_{CV} , the SC811/3 transitions from constant current regulation to constant voltage regulation. While V_{BAT} is regulated to V_{CV} , the current into the battery decreases as the battery becomes fully charged. When the output current drops below the termination threshold current, charging terminates. Upon termination, the STATB pin open drain output turns off and the charger either enters monitor state or float-charges the battery, depending on the logical state of the ENB input pin.

The termination threshold current is fixed at 10% of the adapter mode fast-charge current, as programmed by the resistance between IPRGM and GND, for all charging modes. If only the USB modes will be used, the termination threshold current can be programmed independently of the fast-charge current. (See the application sections, Independent Programming of Termination Current, and USB-only Charging of Very Large Batteries.)

Charger output current is the sum of the battery charge current and the system load current. Battery charge current changes gradually, and establishes a slowly diminishing lower bound on the output current while charging in CV mode. The load current into a typical digital system is highly transient in nature. Charge cycle termination is detected when the sum of the battery charging current and the greatest load current occurring within the immediate 300 μ s to 550 μ s past interval is less than the programmed termination current. This timing behavior permits charge cycle termination to occur during a brief low-load-current interval, and does not require that the longer interval average load current be small.

Termination threshold current accuracy is dominated by offset error. The range of expected termination current versus programming resistance R_{IPRGM} (for any charging mode) is shown in Figures 3a and 3b. Each figure shows

Applications Information (continued)

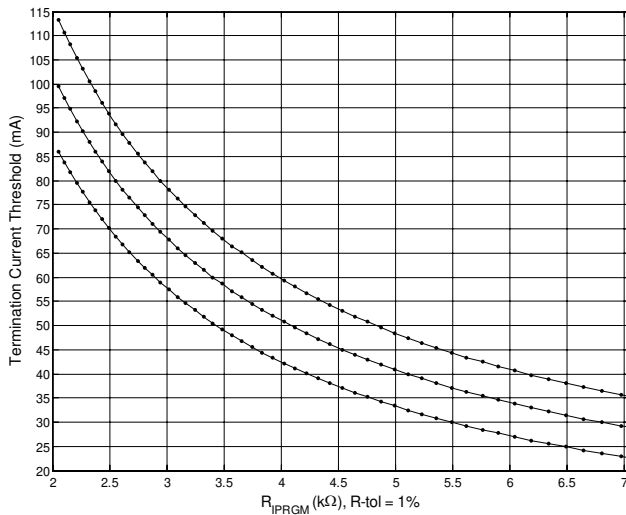

Figure 3a — Termination Current Tolerance vs. Programming Resistance, Low Resistance Range

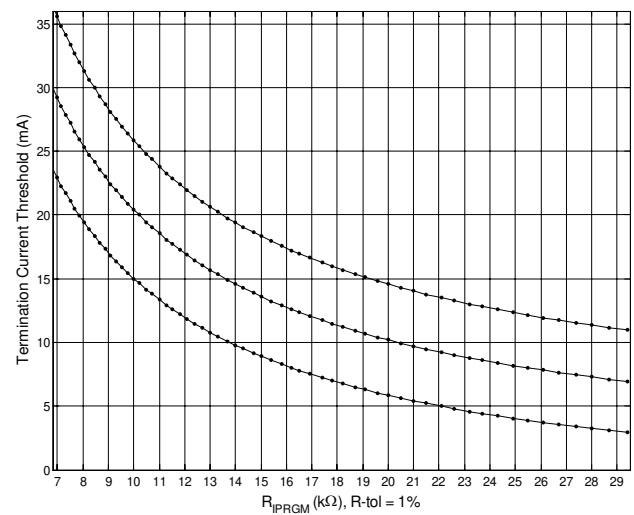

Figure 3b — Termination Current Tolerance vs. Programming Resistance, High Resistance Range

the nominal termination current versus nominal R_{IPRGM} resistance as the center plot and two theoretical limit plots indicating maximum and minimum current vs. nominal programming resistance. These plots are derived from models of the expected worst-case contribution of error sources depending on programmed current. The current range includes the uncertainty due to a 1% tolerance resistor. The dots on each plot indicate the currents obtained with standard value 1% tolerance resistors. Figures 3a and 3b show low and high resistance ranges, respectively.

Tri-level Logical Input Pins

The MODE and ENB pins are tri-level logical inputs. They are designed to interface to a processor GPIO port that is powered from a peripheral supply voltage as low as 1.8V or as high as a fully charged battery. While a connected GPIO port is configured as an output, the processor writes 0 to select ENB or MODE low-range, and 1 to select high-range. The GPIO port is configured as an input to select mid-range.

These pins can also be permanently grounded to select low-range or left unconnected to select mid-range for fixed mode operation. The MODE pin can also be permanently connected to a logical high voltage source, such as BAT or a regulated peripheral supply voltage.

The equivalent circuit looking into these pins is a variable resistance, minimum 15kΩ, to an approximately 1V source.

The input will float to mid range whenever the external driver sinks or sources less than 5μA, a common worst-case characteristic of a high impedance GPIO, or a weak pull-up or pull-down GPIO, configured as an input. The driving GPIO must be able to sink or source at least 75μA to ensure a low or high state, respectively, although the drive current is typically far less. (See the Electrical Characteristics table.)

Mode Input

The MODE pin is a tri-level logical input. When driven high ($V_{MODE} > \text{Min } V_{IH}$), the SC811/3 will operate in USB High Power mode. If the MODE input voltage is within its specified mid range ($\text{Min } V_{IM} < V_{ENB} < \text{Max } V_{IM}$), either by floating (by reconfiguring its GPIO as an input) or by being externally forced, the SC811/3 will operate in USB Low Power mode. When driven low ($V_{MODE} < \text{Max } V_{IL}$), the SC811/3 will operate in adapter mode.

When there is no charging source present, when the charger is disabled, or when operating in the monitor state (described in a later section), the MODE pin enters a high impedance state, suspending the tri-level functionality. Upon re-charge or re-enabling the charger, the MODE pin tri-level interface is reactivated.

Typically a processor GPIO port direction defaults to input upon processor reset, or is high impedance when unpowered. This is the ideal initial condition for driving the MODE pin, since this will select USB Low Power mode,

Applications Information (continued)

which is the safest default mode with the lowest fast-charge current.

Enable Input

The ENB pin is a tri-level logical input that allows selection of the following behaviors:

- charging enabled with float-charging after termination (ENB = low range)
- charging enabled with float-charging disabled and battery monitoring at termination (ENB = mid range)
- charging disabled (ENB = high range).

If the ENB input voltage is permitted to float to mid-range, the charger is enabled but it will turn off its output following charge termination and will enter the monitor state. This state is explained in the next section. Mid-range can be selected either by floating the input (sourcing or sinking less than $5\mu\text{A}$) or by being externally forced such that V_{ENB} falls within the midrange limits specified in the Electrical Characteristics table.

When driven low ($V_{\text{ENB}} < \text{Max } V_{\text{IL}}$), the charger is enabled and will continue to float-charge the battery following termination. If the charger is already in monitor state following a previous termination, it will exit the monitor state and begin float-charging.

When ENB is driven high ($V_{\text{ENB}} > \text{Min } V_{\text{IH}}$), the charger is disabled and the ENB input pin enters a high impedance state, suspending tri-level functionality. The specified high level input current I_{IH} is required only until a high level is recognized by the SC811/3 internal logic. The tri-level float circuitry is then disabled and the ENB input becomes high impedance. Once forced high, the ENB pin will not float to mid range. To restore tri-level operation, the ENB pin must first be pulled down to mid or low range (at least to $V_{\text{ENB}} < \text{Max } V_{\text{IM}}$), then, if desired, released (by reconfiguring the GPIO as an input) to select mid-range. If the ENB GPIO has a weak pull-down when configured as an input, then it is unnecessary to drive ENB low to restore tri-level operation; simply configure the GPIO as an input. When the ENB selection changes from high-range to mid- or low-range, a new charge cycle begins and STATB goes low.

Note that if a GPIO with a weak pull-up input configuration is used, its pull-up current will flow from the GPIO into the ENB pin while it is floating to mid-range. Since the GPIO is driving a 1V equivalent voltage source through a resistance (looking into ENB), this current is small — possibly less than $1\mu\text{A}$. Nevertheless, this current is drawn from the GPIO peripheral power supply and, therefore, from the battery after termination. (See the next section, Monitor State.) For this reason, it is preferable that the GPIO chosen to operate the ENB pin should provide a true high impedance (CMOS) configuration or a weak pull-down when configured as an input. When pulled below the float voltage, the ENB pin output current is sourced from VIN, not from the battery.

Monitor State

If the ENB pin is floating, the charger output and STATB pin will turn off and the device will enter the monitor state when a charge cycle is complete. If the battery voltage falls below the re-charge threshold ($V_{\text{CV}} - V_{\text{ReQ}}$) while in the monitor state, the charger will automatically initiate a re-charge cycle. The battery leakage current during monitor state is no more than $1\mu\text{A}$ over temperature and typically less than $0.1\mu\text{A}$ at room temperature.

While in the monitor state, the ENB tri-level input pin remains fully active, and although in midrange, is sensitive to both high and low levels. The SC811/3 can be forced from the monitor state (no float-charging) directly to float-charging operation by driving ENB low. This operation will turn on the charger output, but will not assert the STATB output. If the ENB pin is again allowed to float to mid-range, the charger will remain on only until the output current becomes less than the termination current, and charging terminates. The SC811/3 turns off its charging output and returns to the monitor state within a millisecond. This forced re-charge behavior is useful for periodically testing the battery state-of-charge and topping-off the battery, without float-charging and without requiring the battery to discharge to the automatic re-charge voltage. ENB should be held low for at least 1ms to ensure a successful forced re-charge.

Forced re-charge can be requested at any time during the charge cycle, or even with no charging source present, with no detrimental effect on charger operation. This allows the host processor to schedule a forced re-charge

Applications Information (continued)

at any desired interval, without regard to whether a charge cycle is already in progress, or even whether a charging source is present. Forced re-charge will neither assert nor release the STATB output.

Status Output

The STATB pin is an open-drain output. It is asserted (driven low) as charging begins after a valid charging input is applied and the VIN voltage is greater than the UVLO level and less than the OVP level of the selected mode. STATB is also asserted as charging begins after the ENB input returns to either of the enable voltage ranges (mid or low voltage) from the disable (high voltage) range. STATB is subsequently released when the termination current is reached to indicate end-of-charge, when the ENB input is driven high to disable charging, or when the input voltage is removed. If the battery is already fully charged when a charge cycle is initiated, STATB is asserted, and will remain asserted for approximately 750µs before being released. The STATB pin is not asserted for automatic re-charge cycles.

The STATB pin may be connected to an interrupt input to notify a host controller of the charging status or it can be used as an LED driver.

Logical CC-to-CV Transition

The SC811/3 differs from monolithic linear single cell Li-ion chargers that implement a linear transition from CC to CV regulation. The linear transition method uses two simultaneous feedback signals — output voltage and output current — to the closed-loop controller. When the output voltage is sufficiently below the CV regulation voltage, the influence of the voltage feedback is negligible and the output current is regulated to the desired current. As the battery voltage approaches the CV regulation voltage (4.2V), the voltage feedback signal begins to influence the control loop, which causes the output current to decrease although the output voltage has not reached 4.2V. The output voltage limit dominates the controller when the battery reaches 4.2V and eventually the controller is entirely in CV regulation. The soft transition effectively reduces the charge current below that which is permitted for a portion of the charge cycle, which increases charge time.

In the SC811/3, a logical transition is implemented from CC to CV to recover the charge current lost due to the soft transition. The controller regulates only current until the output voltage exceeds the transition threshold voltage. It then switches to CV regulation. The transition voltage from CC to CV regulation is typically 5mV higher than the CV regulation voltage, which provides a sharp and clean transition free of chatter between regulation modes. The difference between the transition voltage and the regulation voltage is termed the CC/CV overshoot. While in CV regulation, the output current sense remains active. If the output current exceeds by 5% the mode-dependent programmed fast-charge current, the controller reverts to current regulation.

The logical transition from CC to CV results in the fastest possible charging cycle that is compliant with the specified current and voltage limits of the Li-ion cell. The output current is constant at the CC limit, then decreases abruptly when the output voltage steps from the overshoot voltage to the regulation voltage at the transition to CV control.

Thermal Limiting

Device thermal limiting is the third output constraint of the Constant Current, Constant Voltage, “Constant” Temperature (CC/CV/CT) control. This feature permits a higher input OVP threshold, and thus the use of higher voltage or poorly regulated adapters. If high input voltage results in excessive power dissipation, the output current is reduced to prevent overheating of the SC811/3. The thermal limiting controller reduces the output current by $i_T \approx 50\text{mA}/^\circ\text{C}$ for any junction temperature $T_J > T_{TL}$.

When thermal limiting is inactive,

$$T_J = T_A + V_{\Delta} I_{FQ} \theta_{JA'}$$

where V_{Δ} is the voltage difference between the VIN pin and the BAT pin. However, if T_J computed this way exceeds T_{TL} , then thermal limiting will become active and the thermal limiting regulation junction temperature will be

$$T_{JTL} = T_A + V_{\Delta} I(T_{JTL}) \theta_{JA'}$$

where

$$I(T_{JTL}) = I_{FQ} - i_T (T_{JTL} - T_{TL}).$$

Applications Information (continued)

Combining these two equations and solving for T_{JTL} , the steady state junction temperature during active thermal limiting is

$$T_{JTL} = \frac{T_A + V_{\Delta} (I_{FQ-x} + i_T T_{TL}) \theta_{JA}}{1 + V_{\Delta} i_T \theta_{JA}}$$

Although the thermal limiting controller is able to reduce output current to zero, this does not happen in practice. Output current is reduced to $I(T_{JTL})$, reducing power dissipation such that die temperature equilibrium T_{JTL} is reached.

While thermal limiting is active, all charger functions remain active and the charger logical state is preserved.

Operating a Charging Adapter in Current Limit

In high charging current applications, charger power dissipation can be greatly reduced by operating the charging adapter in current limit. The SC811/3 adapter mode supports adapter-current-limited charging with a low UVLO falling threshold and with internal circuitry designed for low input voltage operation. To operate an adapter in current limit, R_{IPRGM} is chosen such that the adapter input programmed fast-charge current I_{FQ-AD} exceeds the current limit of the charging adapter I_{AD-LIM} .

Note that if I_{AD-LIM} is less than 20% of I_{FQ-AD} , then the adapter voltage can be pulled down to the battery voltage while the battery voltage is below the pre-charge threshold. In this case, care must be taken to ensure that the adapter will maintain its current limit below 20% of I_{FQ-AD} at least until the battery voltage exceeds the pre-charge threshold. Failure to do so could permit charge current to exceed the pre-charge current while the battery voltage is below the pre-charge threshold. This is because the low input voltage will also compress the pre-charge threshold internal reference voltage to below the battery voltage. This will prematurely advance the charger logic from pre-charge current regulation to fast-charge regulation, and the charge current will exceed the safe level recommended for pre-charge conditioning.

The low UVLO falling threshold ($V_{T_{ADUVLO-F}}$) permits the adapter voltage to be pulled down to just above the battery voltage by the charging load whenever the adapter current limit is less than the programmed fast-

charge current. The SC811/3 should be operated with adapter voltage below the rising selection threshold ($V_{T_{ADUVLO-R}}$) only if the low input voltage is the result of adapter current limiting. This implies that the VIN voltage first exceeds $V_{T_{ADUVLO-R}}$ to begin charging and is subsequently pulled down to just above the battery voltage by the charging load.

Interaction of Thermal Limiting and Current Limited Adapter Charging

To permit the charge current to be limited by the adapter, it is necessary that the adapter mode fast-charge current be programmed greater than the maximum adapter current, (I_{AD-LIM}). In this configuration, the CC regulator will operate with its pass device fully on (in saturation, also called "dropout"). The voltage drop from VIN to BAT is determined by the product of the minimum R_{DS-ON} of the pass device multiplied by the adapter supply current.

In dropout, the power dissipation in the SC811/3 is $P_{ILIM} = (\text{minimum } R_{DS-ON}) \times (I_{AD-LIM})^2$. Since minimum R_{DS-ON} does not vary with battery voltage, dropout power dissipation is constant throughout the CC portion of the charge cycle while the adapter remains in current limit. The SC811/3 junction temperature will rise above ambient by $P_{ILIM} \times \theta_{JA}$. If the device temperature rises to the temperature at which the thermal limiting control loop limits charging current (rather than the current being limited by the adapter), the input voltage will rise to the adapter regulation voltage. The power dissipation will increase so that the thermal limit regulation will further limit charge current. This will keep the adapter in voltage regulation for the remainder of the charge cycle.

To ensure that the adapter remains in current limit, the internal device temperature must never rise to T_{TL} . This implies that θ_{JA} must be kept small enough to ensure that $T_J = T_A + (P_{ILIM} \times \theta_{JA}) < T_{TL}$.

Under-Voltage Load Regulation in USB Modes

VIN pin UVLR in either USB mode prevents the battery charging current from overloading the USB Vbus network, regardless of the programmed fast-charge value. When USB High Power or USB Low Power mode is selected, the SC811/3 monitors the input voltage (V_{VIN}) and reduces the charge current as necessary to keep V_{VIN} at or above the UVLR limit (V_{UVLR}). UVLR operates like a fourth output con-

Applications Information (continued)

straint (along with CC, CV, and CT constraints), but it is active only when one of the USB modes is selected.

In either of the USB modes, if the VIN voltage is externally pulled below V_{UVLR} , the UVLR feature will reduce the charging current to zero. This condition will not be interpreted as termination and will not result in an end-of-charge indication. The STATB pin will remain asserted as if charging is continuing. This behavior prevents repetitive indications of end-of-charge alternating with start-of-charge in the case that the external VIN load is removed or is intermittent.

USB High Power and Low Power Support

The USB specification restricts the load on the USB Vbus power network to 100mA for low power devices and for high power devices prior to granting permission for high power operation. The specification restricts the Vbus load to 500mA for high power devices after granting permission to operate as a high power device. A fixed 1:5 ratio of low power to high power charging current is desirable for charging batteries with maximum fast-charge current of at least 500mA. For this application, the SC811/3 provides fixed 1:5 current ratio low-to-high power mode support, via the tri-level MODE input pin.

For batteries with maximum fast-charge current less than 500mA, a fixed 1:5 low/high power charge current ratio will result in suboptimal charging in USB low power mode. For example, a 250mAh battery will typically require a fast-charge current of 250mA or less. A fixed 1:5 ratio for USB low-to-high power charging current will unnecessarily reduce charging current to 50mA, well below the 100mA permitted. In this case, it may be preferable to program USB low-power fast-charge current by switching an external programming resistor. See the section Design Considerations — Small Battery.

Input Over-Voltage Protection

The VIN pin is protected from over-voltage to at least 30V above GND. When the input voltage exceeds the Over-Voltage Protection (OVP) rising threshold ($V_{T_{OVP-R}}$), charging is halted. When the input voltage falls below the OVP falling threshold ($V_{T_{OVP-F}}$), charging restarts. An OVP fault turns off the STATB output. STATB is turned on again when charging restarts.

The OVP threshold of the SC811 has been set relatively high to permit the use of poorly regulated adapters. Such adapters may output a high voltage until loaded by the charger. A too-low OVP threshold could prevent the charger from ever turning on and loading the adapter to a lower voltage. If the adapter voltage remains high despite the charging load, the fast thermal limiting feature will immediately reduce the charging current to prevent overheating of the SC811. This behavior is illustrated in Figure 4, in which $V_{BAT} = 3.0V$, $I_{FQ} = 700mA$, and V_{VIN} is stepped from 0V to 8.1V. Initially, power dissipation in the SC811 is 3.6W.

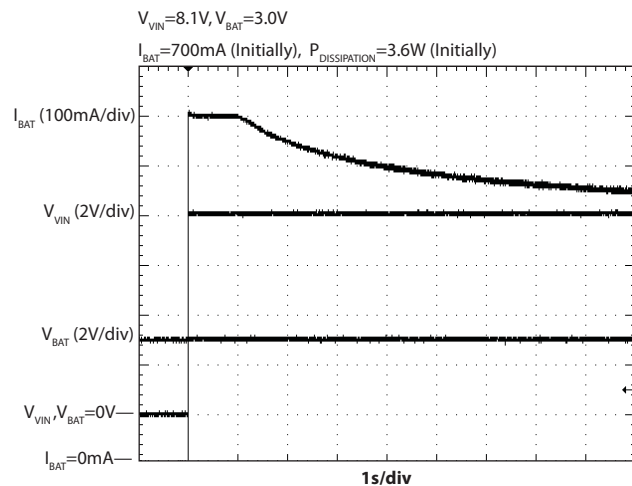

Figure 4 — SC811 Thermal Limiting Example

Notice the BAT output current is rapidly reduced to limit the internal die temperature, then continues to decline as the circuit board gradually heats up, further reducing the conduction of heat from the die to the ambient environment. The fast thermal limiting feature ensures compliance with CCSA YD/T 1591-2006, *Telecommunication Industrial Standard of the People's Republic of China — Technical Requirements and Test Method of Charger and Interface for Mobile Telecommunication Terminal*, Section 4.2.3.1.

Alternatively, the SC813 is offered for users who want to limit OVP to a guaranteed maximum of 6V. The SC811 and SC813 are alike except for OVP threshold.

Short Circuit Protection

The SC811/3 can tolerate a BAT pin short circuit to ground indefinitely. The current into a ground short is approximately 10mA.

Applications Information (continued)

During charging, a short to ground applied to the active current programming pin (IPRGM or IPUSB) is detected, while a short to ground on the inactive programming pin is ignored. Pin-short detection on an active current programming pin forces the SC811/3 into reset, turning off the output. A pin-short on either programming pin will prevent startup regardless of the mode selected. When the IPRGM or IPUSB pin-short condition is removed, the charger begins normal operation automatically without input power cycling.

Over-Current Protection

Over-current protection is provided in all modes of operation, including CV regulation. The output current is limited to either the programmed pre-charge current limit value or the fast-charge current limit value, depending on the voltage at the output.

Operation Without a Battery

The SC811/3 can be operated as a 4.2V LDO regulator without the battery present, for example, factory testing. If this use is anticipated, the output capacitance C_{BAT} should be at least 2.2 μ F to ensure stability. To operate the charger without a battery, the ENB pin must be driven low or grounded.

Capacitor Selection

Low cost, low ESR ceramic capacitors such as the X5R and X7R dielectric material types are recommended. The BAT pin capacitor range is 1 μ F to 22 μ F. The VIN pin capacitor is typically between 0.1 μ F and 2.2 μ F, although larger values will not degrade performance. Capacitance must be evaluated at the expected bias voltage, rather than the zero-volt capacitance rating.

PCB Layout Considerations

Layout for linear devices is not as critical as for a switching regulator. However, careful attention to detail will ensure reliable operation.

- Place input and output capacitors close to the device for optimal transient response and device behavior.
- Connect all ground connections directly to the ground plane. If there is no ground plane, connect to a common local ground point before connecting to board ground near the GND pin.

- Attaching the part to a larger copper footprint will enable better heat transfer from the device, especially on PCBs with internal ground and power planes.

Design Considerations — Large Battery

A battery with a desired fast-charge current exceeding 500mA is most consistent with the USB fixed 1:5 current ratio low-to-high power model of operation. For example, consider an 800mAh battery, with maximum fast-charge current of 800mA. The adapter input fast-charge should be configured for 800mA max ($R_{IPRGM} = 2.80k\Omega$). Select $R_{IPUSB} = 4.53k\Omega$ to set USB high power fast-charge to 450mA, and the USB low power fast-charge set to $450/5 = 90mA$. The MODE pin tri-level logical input can be used to select between USB high power and USB low power modes whenever a fixed 5:1 current ratio is desired.

Design Considerations — Small Battery

A battery with a desired fast-charge current less than 500mA will not be charged in minimum charge time when in USB low power mode of operation with a 1:5 low-to-high power mode current ratio. A 300mAh battery can be used as an example with maximum fast-charge current of 300mA. In this example, the adapter input and USB input high power fast-charge currents should both be set to 300mA. The USB low power fast-charge current of, for example, 90mA, for a low-to-high power current ratio of 1:3.3, would provide a shorter charge time than the 60mA obtained with the fixed USB low-to-high power charging current ratio of 1:5.

An arbitrary ratio of USB low-to-high power charging currents can be obtained using an external n-channel FET operated with a processor GPIO signal to engage a second parallel IPUSB resistor, while selecting high power mode (MODE pin driven high) for both low or high power charging. The external circuit is illustrated in Figure 5.

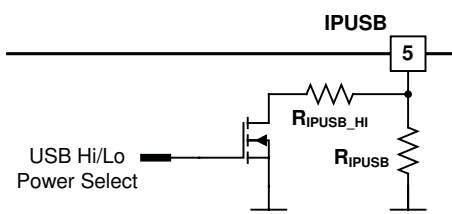

Figure 5. External programming of arbitrary USB high power and low power charge currents.

Applications Information (continued)

For USB low power mode charging, the external transistor is turned off. The transistor is turned on when high power mode is desired. The effect of the switched parallel IPUSB resistor is to reduce the effective programming resistance and thus raise the fast-charge current.

An open-drain GPIO can be used directly to engage the parallel resistor R_{IPUSB_HI} . Care must be taken to ensure that the R_{DS-ON} of the GPIO is considered in the selection of R_{IPUSB_HI} . Also important is the part-to-part and temperature variation of the GPIO R_{DS-ON} and their contribution to the USB High Power charge current tolerance. Note also that IPUSB will be pulled up briefly to as high as 3V during startup to check for an IPUSB static pinshort to ground. A small amount of current could, potentially, flow from IPUSB into the GPIO ESD structure through R_{IPUSB_HI} during this event. While unlikely to do any harm, this effect must also be considered.

The 300mAh battery example can be used to illustrate how this system works. The adapter mode and USB high power mode fast-charge currents should both be set to 300mA max. The USB input low power fast-charge current is 100mA max. Refer to the circuit in Figure 5 and the data of Figures 1a and 1b. For $I_{FQ_AD} = 300\text{mA max}$, use $R_{IPRGM} = 7.50\text{k}\Omega$. A fixed IPUSB resistor of $R_{IPUSB} = 23.2\text{k}\Omega$ programs $I_{FQ_USB} = 100\text{mA max}$ for USB low power charging. When a parallel resistor $R_{IPUSB_HI} = 11.0\text{k}\Omega$ resistor is switched in, the equivalent IPUSB resistor is $7.50\text{k}\Omega$, for $I_{FQ_USB} = 300\text{mA max}$.

USB Low Power Mode Alternative

Where a USB mode selection signal is not available, or for a low capacity battery where system cost or board space make USB low power mode external current programming impractical, USB low power charging can be supported indirectly. The IPUSB pin resistance can be selected to obtain the desired USB high power charge current. Then, with the MODE pin always configured for USB high power mode, the UVLR feature will ensure that the charging load on the VIN pin will never pull the USB Vbus supply voltage below V_{UVLR} regardless of the host or hub supply limit. The UVLR limit voltage guarantees that the voltage of the USB Vbus supply will not be loaded below the low power voltage specification limit, as seen by any other low power devices connected to the same USB host or hub.

Independent Programming of Termination Current

The USB high power mode fast-charge current is limited to 1000mA, twice the USB high power load limit, and so this mode may also be used for general purpose adapter charging. The IPRGM pin resistance to ground determines the USB high power mode pre-charge current, and the termination threshold current for all modes. If adapter mode will not be used in the application, R_{IPRGM} can be selected to program only the termination threshold current independently of the fast-charge current, which is programmed with R_{IPUSB} .

Note that USB high power mode invokes Under-Voltage Load Regulation, so if charging with an adapter in current limit, the input voltage can be pulled down no lower than V_{UVLR} .

USB-only Charging of Very Large Batteries

The SC811/3 can support the charging of very large capacity batteries as high as 2Ah using a USB-only charging source. The IPRGM resistance lower limit of 2.05k Ω is intended to limit the fast-charge current while charging in adapter mode to less than 1A. If only USB charging modes will be used, then the IPRGM resistor can be chosen as low as 1k Ω . This extended programming range allows setting the USB high power mode pre-charge current as high as 400mA (still below the USB specification limit), and the charge termination current as high as 200mA. (Both of these currents are determined by R_{IPRGM} .) Note that with $R_{IPRGM} < 2.05\text{k}\Omega$, adapter mode should not be used, as this can result in potentially destructive fast-charge current.

The USB high power and USB low power fast-charge currents and the USB low power pre-charge current are determined by the resistance between IPUSB and GND to comply with USB specified current limits, and so are unaffected by the IPRGM resistor. Termination detection requires that the charger be in CV regulation. If the IPRGM-determined termination threshold current is set higher than the USB low power mode fast-charge current, for example, then charge termination will occur the instant that the battery voltage rises to V_{CV} . Thus USB low power charging will behave as if trickle-charging until fully charged, a perfectly safe and acceptable, although slow, charging scenario.

Outline Drawing — MLPD-UT8 2x2

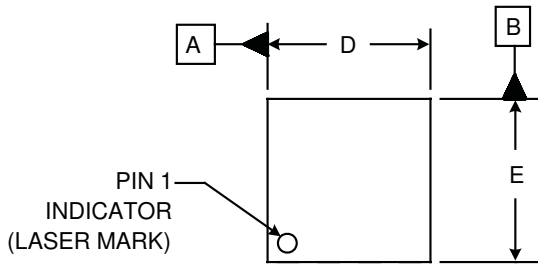

DIM	DIMENSIONS					
	INCHES			MILLIMETERS		
	MIN	NOM	MAX	MIN	NOM	MAX
A	.020	-	.024	0.50	-	0.60
A1	.000	-	.002	0.00	-	0.05
A2	(.006)			(0.1524)		
b	.007	.010	.012	0.18	0.25	0.30
D	.075	.079	.083	1.90	2.00	2.10
D1	.061	.067	.071	1.55	1.70	1.80
E	.075	.079	.083	1.90	2.00	2.10
E1	.026	.031	.035	0.65	0.80	0.90
e	.020 BSC			0.50 BSC		
L	.012	.014	.016	0.30	0.35	0.40
N	8			8		
aaa	.003			0.08		
bbb	.004			0.10		

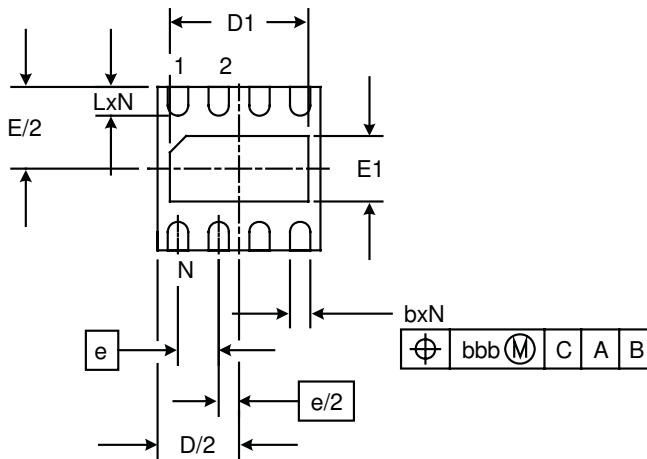
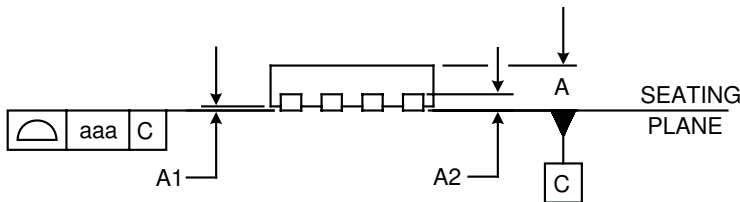

NOTES:

1. CONTROLLING DIMENSIONS ARE IN MILLIMETERS (ANGLES IN DEGREES).
2. COPLANARITY APPLIES TO THE EXPOSED PAD AS WELL AS THE TERMINALS.

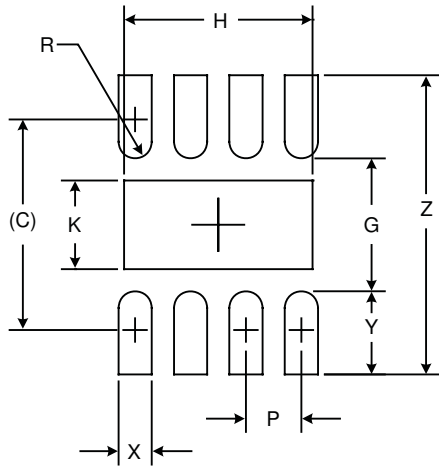
Land Pattern — MLPD-UT8 2x2

DIMENSIONS		
DIM	INCHES	MILLIMETERS
C	(.077)	(1.95)
G	.047	1.20
H	.067	1.70
K	.031	0.80
P	.020	0.50
R	.006	0.15
X	.012	0.30
Y	.030	0.75
Z	.106	2.70

NOTES:

1. CONTROLLING DIMENSIONS ARE IN MILLIMETERS (ANGLES IN DEGREES).
2. THIS LAND PATTERN IS FOR REFERENCE PURPOSES ONLY. CONSULT YOUR MANUFACTURING GROUP TO ENSURE YOUR COMPANY'S MANUFACTURING GUIDELINES ARE MET.
3. THERMAL VIAS IN THE LAND PATTERN OF THE EXPOSED PAD SHALL BE CONNECTED TO A SYSTEM GROUND PLANE. FAILURE TO DO SO MAY COMPROMISE THE THERMAL AND/OR FUNCTIONAL PERFORMANCE OF THE DEVICE.

Contact Information

Semtech Corporation
 Power Management Products Division
 200 Flynn Road, Camarillo, CA 93012
 Phone: (805) 498-2111 Fax: (805) 498-3804

www.semtech.com