



Chipsmall Limited consists of a professional team with an average of over 10 year of expertise in the distribution of electronic components. Based in Hongkong, we have already established firm and mutual-benefit business relationships with customers from,Europe,America and south Asia,supplying obsolete and hard-to-find components to meet their specific needs.

With the principle of “Quality Parts,Customers Priority,Honest Operation,and Considerate Service”,our business mainly focus on the distribution of electronic components. Line cards we deal with include Microchip,ALPS,ROHM,Xilinx,Pulse,ON,Everlight and Freescale. Main products comprise IC,Modules,Potentiometer,IC Socket,Relay,Connector.Our parts cover such applications as commercial,industrial, and automotives areas.

We are looking forward to setting up business relationship with you and hope to provide you with the best service and solution. Let us make a better world for our industry!



## Contact us

Tel: +86-755-8981 8866 Fax: +86-755-8427 6832

Email & Skype: info@chipsmall.com Web: www.chipsmall.com

Address: A1208, Overseas Decoration Building, #122 Zhenhua RD., Futian, Shenzhen, China



## High Power LED Series Chip Scale Package Array

# LH204A

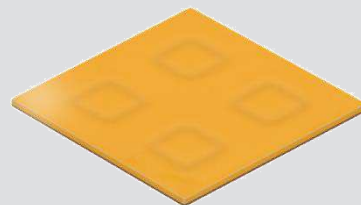

Making use of CSP, Samsung's fundamental "building block", provide with greater design flexibility and better light quality



### Features & Benefits

- Utilizes Samsung TF chip and Flexible substrate platform technology
- Suitable for use in indoor and outdoor directional lighting
- 80 CRI makes it well suited for most applications
- Compact footprint (3.5 x 3.5 mm)

### Applications

- Indoor Lighting: Spotlight, Downlight, MR, PAR
- Industrial Lighting: High Bay Light, Low Bay Light
- Consumer Lighting: Torch Light

## Table of Contents

1.	Characteristics	-----	3
2.	Product Code Information	-----	5
3.	Typical Characteristics Graphs	-----	15
4.	Outline Drawing & Dimension	-----	17
5.	Reliability Test Items & Conditions	-----	18
6.	Soldering Conditions	-----	19
7.	Tape & Reel	-----	20
8.	Label Structure	-----	22
9.	Packing Structure	-----	23
10.	Precautions in Handling & Use	-----	25

## 1. Characteristics

### a) Absolute Maximum Rating

Item	Symbol	Rating	Unit	Condition
Ambient / Operating Temperature	$T_a$	-40 ~ +105	°C	Note 1)
Storage Temperature	$T_{stg}$	-40 ~ +120	°C	-
LED Junction Temperature	$T_j$	130	°C	-
Forward Current	$I_F$	350	mA	-
Assembly Process Temperature	-	260 <10	°C s	-
ESD (HBM)	-	±2	kV	-

#### Note:

- 1) Refer to the derating curve, '3. Typical Characteristics Graph', for proper driving current that maintained below maximum junction temperature.

## b) Electro-optical Characteristics (IF = 150 mA)

Item	Unit	Nominal CCT (K)	Condition		Value Typ.
			I <sub>F</sub> (mA)	T <sub>s</sub> (°C)	
Luminous Flux (Φ <sub>v</sub> )	lm	2700 (80 CRI)	150	25	235
			150	85	215
			200	85	278
			250	85	338
Forward Voltage (V <sub>F</sub> )	V		150	25	12.2
			150	85	11.6
			200	85	11.9
			250	85	12.1
Reverse Voltage (@ -10 μA)	V				(min) -10.0
Thermal Resistance (junction to solder point)	°C/W				2.5
Beam Angle	°				120

**Note:**

Samsung maintains measurement tolerance of: luminous flux = ±7%, forward voltage = ±0.1 V

## 2. Product Code Information

1	2	3	4	5	6	7	8	9	10	11	12	13	14	15	16	17	18
S	C	A	8	W	T	7	8	H	A	L	4	W	0	A	E	1	F

Digit	PKG Information	Code	Specification				
1 2 3	Samsung Chip Scale Package Array	<b>SCA</b>					
4	CRI	<b>7</b> <b>8</b> <b>9</b>	Min. 70 Min. 80 Min. 90				
5	CCT	<b>W</b> <b>V</b> <b>U</b> <b>T</b> <b>R</b> <b>Q</b> <b>P</b>	2700K 3000K 3500K 4000K 5000K 5700K 6500K				
6	Chip Shape	<b>T</b>	Square type				
7 8 9	Product	<b>78H</b>	Chip version				
10 11 12	Product Purpose	<b>AL4</b>	4 chips in 1 array				
13 14	CCT (K)	<b>W 0</b> <b>V 0</b> <b>U 0</b> <b>T 0</b> <b>R T</b> <b>Q T</b> <b>P T</b>	2700 3000 3500 4000 5000 5700 6500	Bin Code: T1, T2, T3, T4, T5, T6, T7, T8, T9, TA, TB, TC, TD, TE, TF, TG	W1, W2, W3, W4, W5, W6, W7, W8, W9, WA, WB, WC, WD, WE, WF, WG V1, V2, V3, V4, V5, V6, V7, V8, V9, VA, VB, VC, VD, VE, VF, VG U1, U2, U3, U4, U5, U6, U7, U8, U9, UA, UB, UC, UD, UE, UF, UG	R1, R2, R3, R4 Q1, Q2, Q3, Q4 P1, P2, P3, P4	
15 16	Luminous Flux	<b>6A</b> <b>7B</b> <b>8D</b> <b>AE</b> <b>BG</b> <b>DH</b>	165 ~ 200 175 ~ 215 185 ~ 230 200 ~ 245 215 ~ 260 230 ~ 280	67 78 8A AB BD DE EG GH	165 ~ 175 175 ~ 185 185 ~ 200 200 ~ 215 215 ~ 230 230 ~ 245 245 ~ 260 260 ~ 280		
			Digit 15: Min. spec Digit 18: Max. spec e.g.: BD = 215~230 lm, BG = BD + DE + EG = 215~260 lm				
17 18	Forward Voltage (Vf)	<b>1 F</b>	10.6 ~ 12.9 V				



a) Luminous Flux Bins and Characteristics ( $I_F = 150 \text{ mA}$ ,  $T_s = 85^\circ\text{C}$ )

CRI ( $R_a$ ) Min. <sup>1)</sup>	Nominal CCT (K)	Product Code	Sorting @ 150 mA (lm)		Calculated Minimum Flux <sup>2)</sup> (lm)			
			Flux Rank	Flux Range <sup>1)</sup>	@ 150 mA (25°C)	@ 200 mA	@ 250 mA	@ 350 mA
70	3000	<b>SCA7VT78HAL4V0BG1F</b>	EG	245 ~ 260	265	316	384	506
			DE	230 ~ 245	249	297	361	475
			BD	215 ~ 230	232	277	337	444
	3500	<b>SCA7UT78HAL4U0BG1F</b>	EG	245 ~ 260	265	316	384	506
			DE	230 ~ 245	249	297	361	475
			BD	215 ~ 230	232	277	337	444
	4000	<b>SCA7TT78HAL9T0AJEP</b>	EG	245 ~ 260	265	316	384	506
			DE	230 ~ 245	249	297	361	475
			BD	215 ~ 230	232	277	337	444
	5000	<b>SCA7RT78HAL9RTAJEP</b>	GH	260 ~ 280	281	335	408	537
			EG	245 ~ 260	265	316	384	506
			DE	230 ~ 245	249	297	361	475
	5700	<b>SCA7QT78HAL4QTDH1F</b>	GH	260 ~ 280	281	335	408	537
			EG	245 ~ 260	265	316	384	506
			DE	230 ~ 245	249	297	361	475
	6500	<b>SCA7PT78HAL4PTBG1F</b>	EG	245 ~ 260	265	316	384	506
			DE	230 ~ 245	249	297	361	475
			BD	215 ~ 230	232	277	337	444

**Notes:**

- 1) Samsung maintains measurement tolerance of: luminous flux =  $\pm 7\%$ , CRI =  $\pm 3$
- 2) Calculated minimum and maximum flux values are for reference only

a) Luminous Flux Bins and Characteristics ( $I_F = 150 \text{ mA}$ ,  $T_s = 85^\circ\text{C}$ )

CRI ( $R_a$ ) Min. <sup>1)</sup>	Nominal CCT (K)	Product Code	Sorting @ 150 mA (lm)		Calculated Minimum Flux <sup>2)</sup> (lm)				
			Flux Rank	Flux Range <sup>1)</sup>	@ 150 mA (25°C)	@ 200 mA	@ 250 mA	@ 350 mA	
80	2700	<b>SCA8WT78HAL4W0AE1F</b>	DE	230 ~ 245	249	297	361	475	
			BD	215 ~ 230	232	277	337	444	
			AB	200 ~ 215	216	258	314	413	
	3000	<b>SCA8VT78HAL4V0AE1F</b>	DE	230 ~ 245	249	297	361	475	
			BD	215 ~ 230	232	277	337	444	
			AB	200 ~ 215	216	258	314	413	
	3500	<b>SCA8UT78HAL4U0AE1F</b>	DE	230 ~ 245	249	297	361	475	
			BD	215 ~ 230	232	277	337	444	
			AB	200 ~ 215	216	258	314	413	
	4000	<b>SCA8TT78HAL4T0BG1F</b>	EG	245 ~ 260	265	316	384	506	
			DE	230 ~ 245	249	297	361	475	
			BD	215 ~ 230	232	277	337	444	
		5000	<b>SCA8RT78HAL4RTBG1F</b>	EG	245 ~ 260	265	316	384	506
				DE	230 ~ 245	249	297	361	475
				BD	215 ~ 230	232	277	337	444

**Notes:**

- 1) Samsung maintains measurement tolerance of: luminous flux =  $\pm 7\%$ , CRI =  $\pm 3$
- 2) Calculated minimum and maximum flux values are for reference only



a) Luminous Flux Bins and Characteristics ( $I_F = 150 \text{ mA}$ ,  $T_s = 85^\circ\text{C}$ )

CRI ( $R_a$ ) Min. <sup>1)</sup>	Nominal CCT (K)	Product Code	Sorting @ 150 mA (lm)		Calculated Minimum Flux <sup>2)</sup> (lm)			
			Flux Rank	Flux Range <sup>1)</sup>	@ 150 mA (25°C)	@ 200 mA	@ 250 mA	@ 350 mA
90	2700	<b>SCA9WT78HAL4W06A1F</b>	8A	185 ~ 200	200	239	290	382
			78	175 ~ 185	189	226	275	362
			67	165 ~ 175	178	213	259	341
	3000	<b>SCA9VT78HAL4V06A1F</b>	8A	185 ~ 200	200	239	290	382
			78	175 ~ 185	189	226	275	362
			67	165 ~ 175	178	213	259	341
	3500	<b>SCA9UT78HAL4U07B1F</b>	AB	200 ~ 215	216	258	314	413
			8A	185 ~ 200	200	239	290	382
			78	175 ~ 185	189	226	275	362
	4000	<b>SCA9TT78HAL4T07B1F</b>	AB	200 ~ 215	216	258	314	413
			8A	185 ~ 200	200	239	290	382
			78	175 ~ 185	189	226	275	362

**Notes:**

- 1) Samsung maintains measurement tolerance of: luminous flux =  $\pm 7\%$ , CRI =  $\pm 3$
- 2) Calculated minimum and maximum flux values are for reference only

b) Color Bins ( $I_F = 150 \text{ mA}$ ,  $T_s = 85 \text{ }^\circ\text{C}$ )

CRI ( $R_a$ ) Min.	Nominal CCT (K)	Product Code	Color Rank	Chromaticity Bins
70	3000	<i>SCA7VT78HAL4V0BG1F</i>	V0 (Whole bin)	V1, V2, V3, V4, V5, V6, V7, V8, V9, VA, VB, VC, VD, VE, VF, VG
	3500	<i>SCA7UT78HAL4U0BG1F</i>	U0 (Whole bin)	U1, U2, U3, U4, U5, U6, U7, U8, U9, UA, UB, UC, UD, UE, UF, UG
	4000	<i>SCA7TT78HAL4T0BG1F</i>	T0 (Whole bin)	T1, T2, T3, T4, T5, T6, T7, T8, T9, TA, TB, TC, TD, TE, TF, TG
	5000	<i>SCA7RT78HAL4RTDH1F</i>	RT (ANSI bin)	R1, R2, R3, R4
	5700	<i>SCA7QT78HAL9QTAJEP</i>	QT (ANSI bin)	Q1, Q2, Q3, Q4
	6500	<i>SCA7PT78HAL9PTAJEP</i>	PT (ANSI bin)	P1, P2, P3, P4
80	2700	<i>SCA8WT78HAL4W0AE1F</i>	W0 (Whole bin)	W1, W2, W3, W4, W5, W6, W7, W8, W9, WA, WB, WC, WD, WE, WF, WG
	3000	<i>SCA8VT78HAL4V0AE1F</i>	V0 (Whole bin)	V1, V2, V3, V4, V5, V6, V7, V8, V9, VA, VB, VC, VD, VE, VF, VG
	3500	<i>SCA8UT78HAL4U0AE1F</i>	U0 (Whole bin)	U1, U2, U3, U4, U5, U6, U7, U8, U9, UA, UB, UC, UD, UE, UF, UG
	4000	<i>SCA8TT78HAL4T0BG1F</i>	T0 (Whole bin)	T1, T2, T3, T4, T5, T6, T7, T8, T9, TA, TB, TC, TD, TE, TF, TG
	5000	<i>SCA8RT78HAL4RTBG1F</i>	RT (ANSI bin)	R1, R2, R3, R4
90	2700	<i>SCA9WT78HAL4W06A1F</i>	W0 (Whole bin)	W1, W2, W3, W4, W5, W6, W7, W8, W9, WA, WB, WC, WD, WE, WF, WG
	3000	<i>SCA9VT78HAL4V06A1F</i>	V0 (Whole bin)	V1, V2, V3, V4, V5, V6, V7, V8, V9, VA, VB, VC, VD, VE, VF, VG
	3500	<i>SCA9UT78HAL4U07B1F</i>	U0 (Whole bin)	U1, U2, U3, U4, U5, U6, U7, U8, U9, UA, UB, UC, UD, UE, UF, UG
	4000	<i>SCA9TT78HAL4T07B1F</i>	T0 (Whole bin)	T1, T2, T3, T4, T5, T6, T7, T8, T9, TA, TB, TC, TD, TE, TF, TG

c) Voltage Bins ( $I_f = 150 \text{ mA}$ ,  $T_s = 85 \text{ }^\circ\text{C}$ )

CRI ( $R_a$ ) Min.	Nominal CCT (K)	Product Code	Voltage Rank	Voltage Bin	Voltage Range (V)
			1F		10.6 ~ 12.9V

d) Chromaticity Region & Coordinates ( $I_f = 150 \text{ mA}$ ,  $T_s = 85^\circ\text{C}$ )

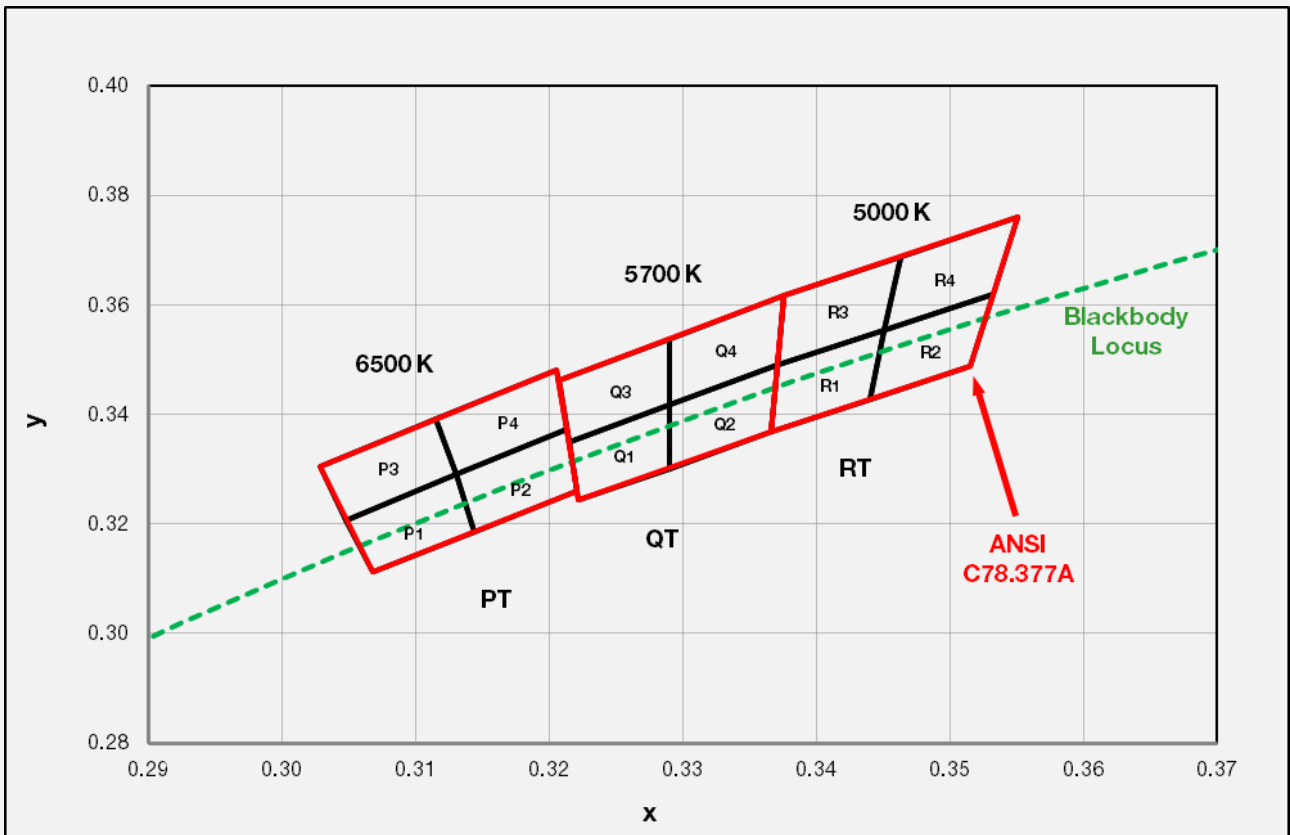
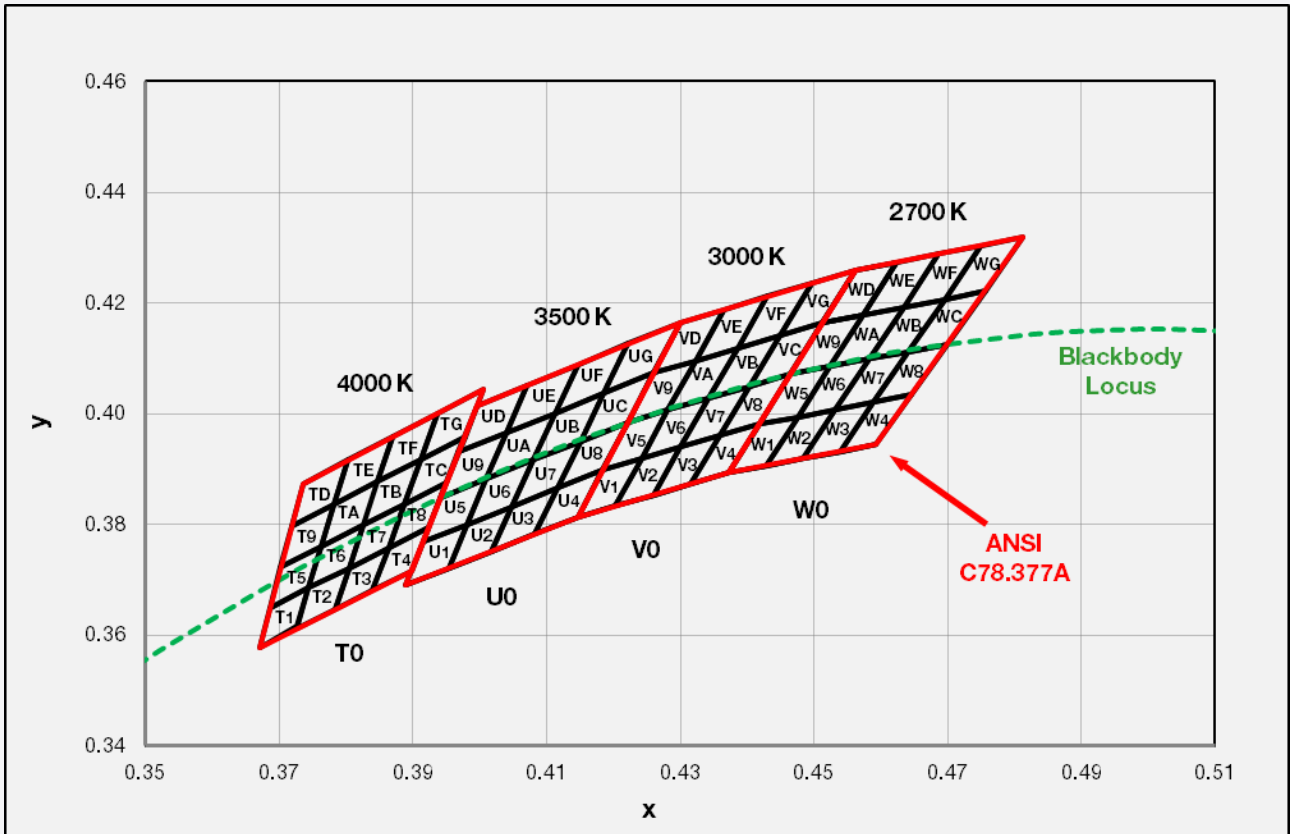

**d) Chromaticity Region & Coordinates ( $I_F = 150 \text{ mA}$ ,  $T_s = 85 \text{ }^\circ\text{C}$ )**

Region	CIE x	CIE y	Region	CIE x	CIE y
<b>W rank (2700 K)</b>					
W1	0.4373	0.3893	W9	0.4465	0.4071
	0.4418	0.3981		0.4513	0.4164
	0.4475	0.3994		0.4573	0.4178
	0.4428	0.3906		0.4523	0.4085
W2	0.4428	0.3906	WA	0.4523	0.4085
	0.4475	0.3994		0.4573	0.4178
	0.4532	0.4008		0.4634	0.4193
	0.4483	0.3919		0.4582	0.4099
W3	0.4483	0.3919	WB	0.4582	0.4099
	0.4532	0.4008		0.4634	0.4193
	0.4589	0.4021		0.4695	0.4207
	0.4538	0.3931		0.4641	0.4112
W4	0.4538	0.3931	WC	0.4641	0.4112
	0.4589	0.4021		0.4695	0.4207
	0.4646	0.4034		0.4756	0.4221
	0.4593	0.3944		0.4700	0.4126
W5	0.4418	0.3981	WD	0.4513	0.4164
	0.4465	0.4071		0.4562	0.4260
	0.4523	0.4085		0.4624	0.4274
	0.4475	0.3994		0.4573	0.4178
W6	0.4475	0.3994	WE	0.4573	0.4178
	0.4523	0.4085		0.4624	0.4274
	0.4582	0.4099		0.4687	0.4289
	0.4532	0.4008		0.4634	0.4193
W7	0.4532	0.4008	WF	0.4634	0.4193
	0.4582	0.4099		0.4687	0.4289
	0.4641	0.4112		0.4750	0.4304
	0.4589	0.4021		0.4695	0.4207
W8	0.4589	0.4021	WG	0.4695	0.4207
	0.4641	0.4112		0.4750	0.4304
	0.4700	0.4126		0.4813	0.4319
	0.4646	0.4034		0.4756	0.4221

Region	CIE x	CIE y	Region	CIE x	CIE y
<b>V rank (3000 K)</b>					
V1	0.4147	0.3814	V9	0.4221	0.3984
	0.4183	0.3898		0.4259	0.4073
	0.4242	0.3919		0.4322	0.4096
	0.4203	0.3833		0.4281	0.4006
V2	0.4203	0.3833	VA	0.4281	0.4006
	0.4242	0.3919		0.4322	0.4096
	0.4300	0.3939		0.4385	0.4119
	0.4259	0.3853		0.4342	0.4028
V3	0.4259	0.3853	VB	0.4342	0.4028
	0.4300	0.3939		0.4385	0.4119
	0.4359	0.3960		0.4449	0.4141
	0.4316	0.3873		0.4403	0.4049
V4	0.4316	0.3873	VC	0.4403	0.4049
	0.4359	0.3960		0.4449	0.4141
	0.4418	0.3981		0.4513	0.4164
	0.4373	0.3893		0.4465	0.4071
V5	0.4183	0.3898	VD	0.4259	0.4073
	0.4221	0.3984		0.4299	0.4165
	0.4281	0.4006		0.4364	0.4188
	0.4242	0.3919		0.4322	0.4096
V6	0.4242	0.3919	VE	0.4322	0.4096
	0.4281	0.4006		0.4364	0.4188
	0.4342	0.4028		0.4430	0.4212
	0.4300	0.3939		0.4385	0.4119
V7	0.4300	0.3939	VF	0.4385	0.4119
	0.4342	0.4028		0.4430	0.4212
	0.4403	0.4049		0.4496	0.4236
	0.4359	0.3960		0.4449	0.4141
V8	0.4359	0.3960	VG	0.4449	0.4141
	0.4403	0.4049		0.4496	0.4236
	0.4465	0.4071		0.4562	0.4260
	0.4418	0.3981		0.4513	0.4164

## d) Chromaticity Region &amp; Coordinates

Region	CIE x	CIE y	Region	CIE x	CIE y
<b>U rank (3500 K)</b>					
U1	0.3889	0.3690	U9	0.3941	0.3848
	0.3915	0.3768		0.3968	0.3930
	0.3981	0.3800		0.4040	0.3966
	0.3953	0.3720		0.4010	0.3882
U2	0.3953	0.3720	UA	0.4010	0.3882
	0.3981	0.3800		0.4040	0.3966
	0.4048	0.3832		0.4113	0.4001
	0.4017	0.3751		0.4080	0.3916
U3	0.4017	0.3751	UB	0.4080	0.3916
	0.4048	0.3832		0.4113	0.4001
	0.4116	0.3865		0.4186	0.4037
	0.4082	0.3782		0.4150	0.3950
U4	0.4082	0.3782	UC	0.4150	0.3950
	0.4116	0.3865		0.4186	0.4037
	0.4183	0.3898		0.4259	0.4073
	0.4147	0.3814		0.4221	0.3984
U5	0.3915	0.3768	UD	0.3968	0.3930
	0.3941	0.3848		0.3996	0.4015
	0.4010	0.3882		0.4071	0.4052
	0.3981	0.3800		0.4040	0.3966
U6	0.3981	0.3800	UE	0.4040	0.3966
	0.4010	0.3882		0.4071	0.4052
	0.4080	0.3916		0.4146	0.4089
	0.4048	0.3832		0.4113	0.4001
U7	0.4048	0.3832	UF	0.4113	0.4001
	0.4080	0.3916		0.4146	0.4089
	0.4150	0.3950		0.4222	0.4127
	0.4116	0.3865		0.4186	0.4037
U8	0.4116	0.3865	UG	0.4186	0.4037
	0.4150	0.3950		0.4222	0.4127
	0.4221	0.3984		0.4299	0.4165
	0.4183	0.3898		0.4259	0.4073

Region	CIE x	CIE y	Region	CIE x	CIE y
<b>T rank (4000 K)</b>					
T1	0.3670	0.3578	T9	0.3702	0.3722
	0.3726	0.3612		0.3763	0.3760
	0.3744	0.3685		0.3782	0.3837
	0.3686	0.3649		0.3719	0.3797
T2	0.3726	0.3612	TA	0.3763	0.3760
	0.3783	0.3646		0.3825	0.3798
	0.3804	0.3721		0.3847	0.3877
	0.3744	0.3685		0.3782	0.3837
T3	0.3783	0.3646	TB	0.3825	0.3798
	0.3840	0.3681		0.3887	0.3836
	0.3863	0.3758		0.3912	0.3917
	0.3804	0.3721		0.3847	0.3877
T4	0.3840	0.3681	TC	0.3887	0.3837
	0.3898	0.3716		0.3950	0.3875
	0.3924	0.3794		0.3978	0.3958
	0.3863	0.3758		0.3912	0.3917
T5	0.3686	0.3649	TD	0.3719	0.3797
	0.3744	0.3685		0.3782	0.3837
	0.3763	0.3760		0.3802	0.3916
	0.3702	0.3722		0.3736	0.3874
T6	0.3744	0.3685	TE	0.3782	0.3837
	0.3804	0.3721		0.3847	0.3877
	0.3825	0.3798		0.3869	0.3958
	0.3763	0.376		0.3802	0.3916
T7	0.3804	0.3721	TF	0.3847	0.3877
	0.3863	0.3758		0.3912	0.3917
	0.3887	0.3836		0.3937	0.4001
	0.3825	0.3798		0.3869	0.3958
T8	0.3863	0.3758	TG	0.3912	0.3917
	0.3924	0.3794		0.3978	0.3958
	0.3950	0.3875		0.4006	0.4044
	0.3887	0.3836		0.3937	0.4001

## d) Chromaticity Region &amp; Coordinates

Region	CIE x	CIE y
<b>R rank (5000 K)</b>		
R1	0.3371	0.3490
	0.3451	0.3554
	0.3440	0.3427
	0.3366	0.3369
R2	0.3451	0.3554
	0.3533	0.3620
	0.3515	0.3487
	0.3440	0.3427
R3	0.3376	0.3616
	0.3463	0.3687
	0.3451	0.3554
	0.3371	0.3490
R4	0.3463	0.3687
	0.3551	0.3760
	0.3533	0.3620
	0.3451	0.3554

Region	CIE x	CIE y
<b>Q rank (5700 K)</b>		
Q1	0.3215	0.3350
	0.3290	0.3417
	0.3290	0.3300
	0.3222	0.3243
Q2	0.3290	0.3417
	0.3371	0.3490
	0.3366	0.3369
	0.3290	0.3300
Q3	0.3207	0.3462
	0.3290	0.3538
	0.3290	0.3417
	0.3215	0.3350
Q4	0.3290	0.3538
	0.3376	0.3616
	0.3371	0.3490
	0.3290	0.3417

Region	CIE x	CIE y
<b>P rank (6500 K)</b>		
P1	0.3068	0.3113
	0.3144	0.3186
	0.3130	0.3290
	0.3048	0.3207
P2	0.3144	0.3186
	0.3221	0.3261
	0.3213	0.3373
	0.3130	0.3290
P3	0.3048	0.3207
	0.3130	0.3290
	0.3115	0.3391
	0.3028	0.3304
P4	0.3130	0.3290
	0.3213	0.3373
	0.3205	0.3481
	0.3115	0.3391

**Note:**

Samsung maintains measurement tolerance of:  $C_x, C_y = \pm 0.005$



### 3. Typical Characteristics Graphs

#### a) Spectrum Distribution ( $I_f = 150 \text{ mA}$ , $T_s = 85 \text{ }^\circ\text{C}$ )

Warm White

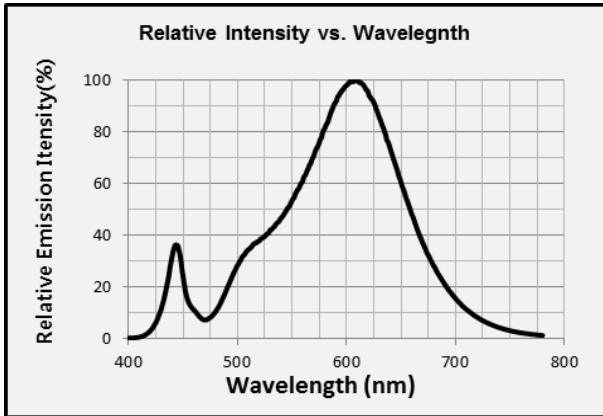

#### b) Forward Current Characteristics ( $T_s = 85 \text{ }^\circ\text{C}$ )

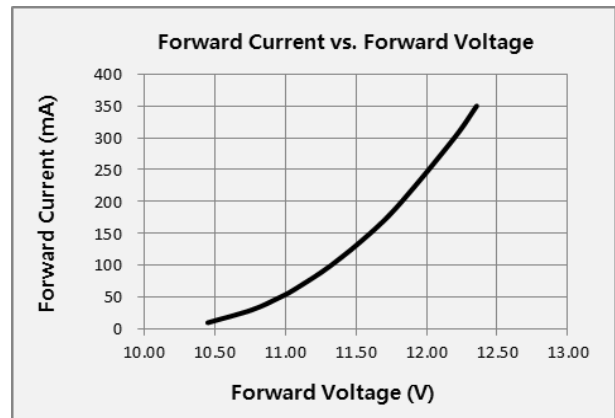
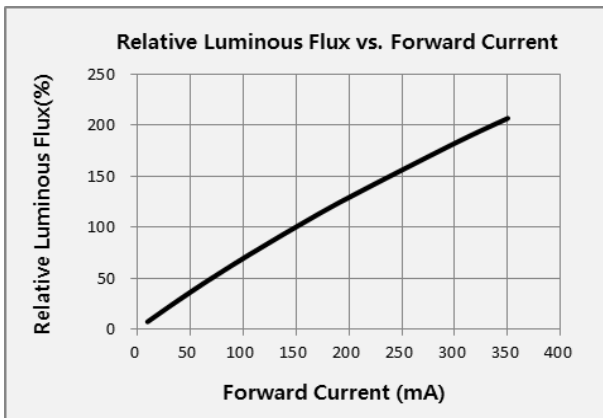

#### c) Temperature Characteristics ( $I_f = 150 \text{ mA}$ )

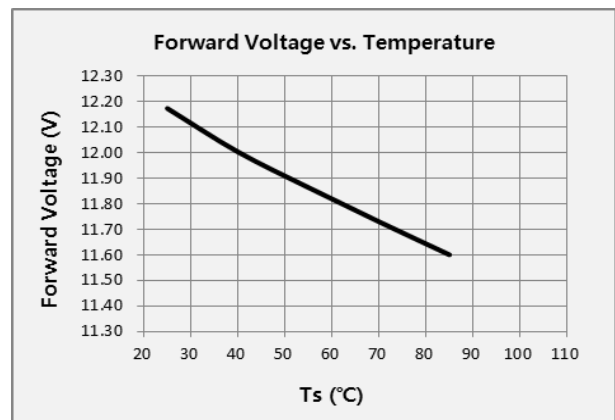
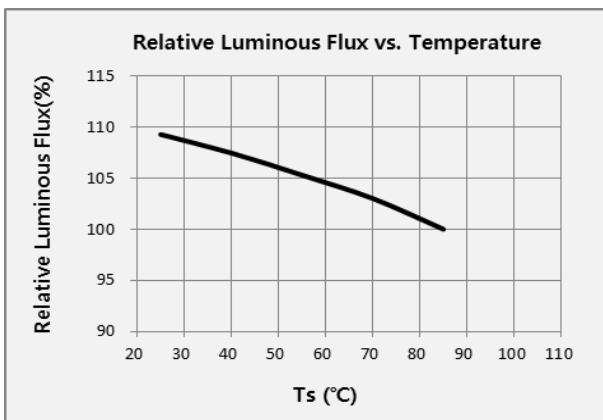

d) Color Shift Characteristics ( $I_F = 150 \text{ mA}$ ,  $T_s = 85 \text{ }^\circ\text{C}$ )

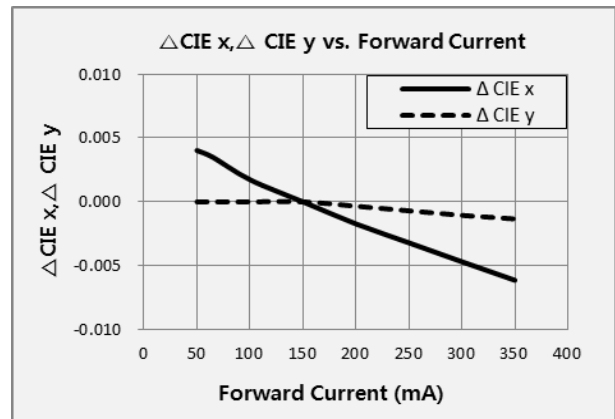
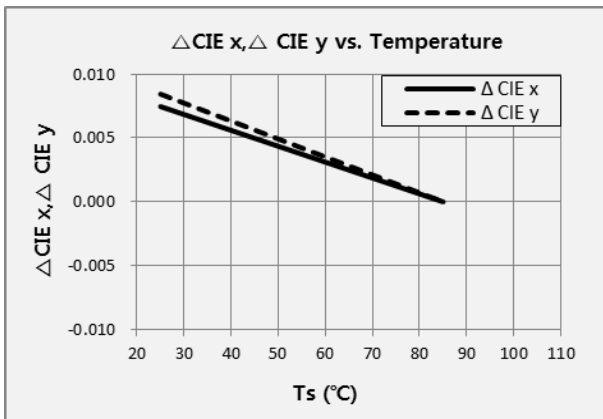

e) Derating Curve and Beam Angle Characteristics ( $I_F = 150 \text{ mA}$ ,  $T_s = 25 \text{ }^\circ\text{C}$ )

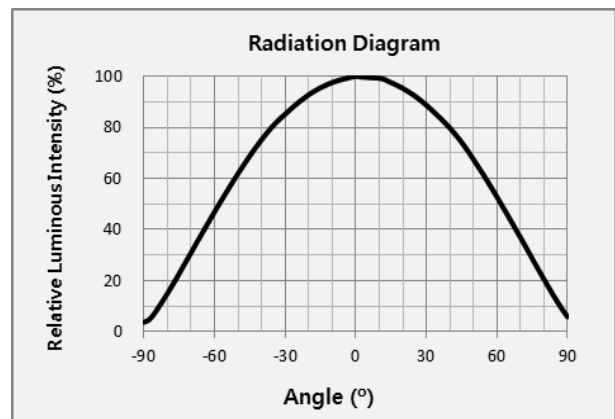
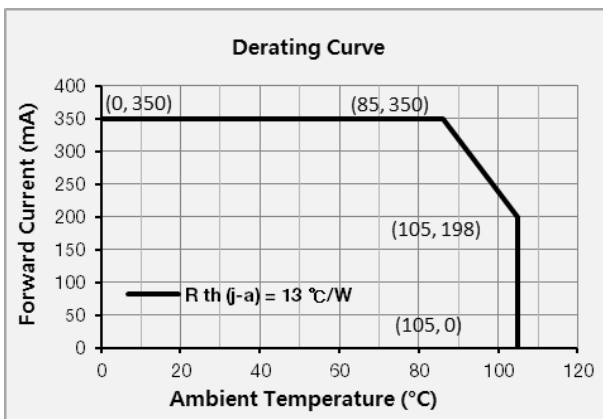

#### 4. Outline Drawing & Dimension

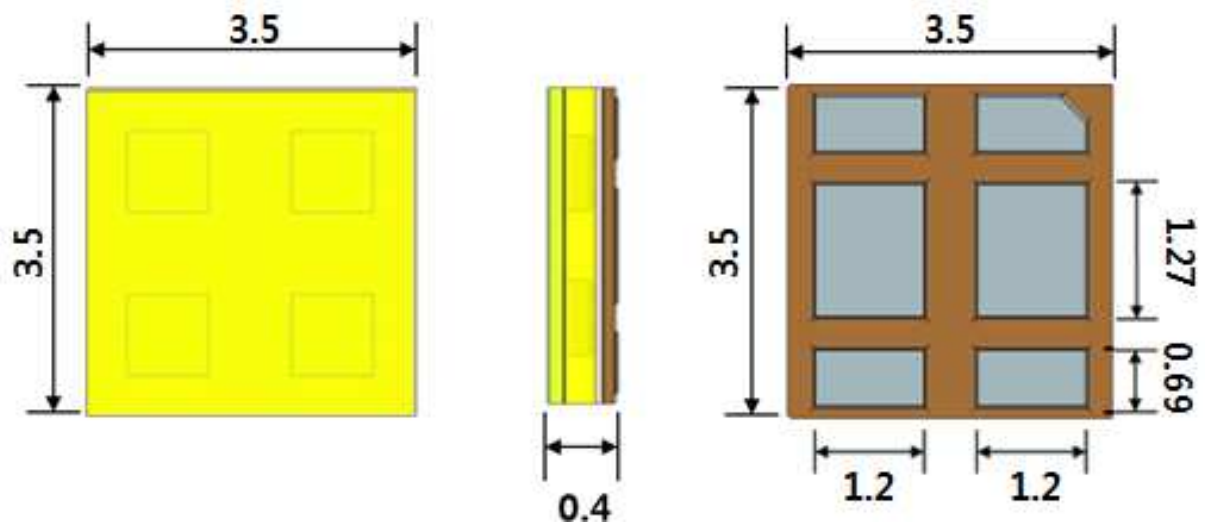

- Measurement unit: mm
- Maximum compressing force is 15 N on the body ①
- Do not place pressure on the encapsulation resin ②

#### Precautions:

- 1) Pressure on the LEDs will influence to the reliability of the LEDs. Precautions should be taken to avoid strong pressure on the LEDs. Do not put stress on the LEDs during heating.
- 2) Re-soldering should not be done after the LEDs have been soldered. If re-soldering is unavoidable, LED's characteristics should be carefully checked before and after such repair.
- 3) Do not stack assembled PCBs together. Since materials of LEDs is soft, abrasion between two PCB assembled with LED might cause catastrophic failure of the LEDs.

## 5. Reliability Test Items & Conditions

### a) Test Items

Test Item	Test Condition	Test Hour / Cycle	Sample No.	
Room Temperature Life Test	25 °C, Derating max current	1000 h	22	
High Temperature Life Test	85 °C, Derating max current	1000 h	22	
High Temperature Humidity Life Test	85 °C, 85 % RH, Derating max current	1000 h	22	
Low Temperature Life Test	-40 °C, Derating max current	1000 h	22	
Powered Temperature Cycle Test	-45 °C / 20 min ↔ 85 °C / 20 min, sweep 100 min cycle on/off: each 5 min, Derating max current	100 cycles	22	
Thermal Shock	-45 °C / 15 min ↔ 125 °C / 15 min → Hot plate 180 °C	500 cycles	100	
High Temperature Storage	120 °C	1000 h	11	
Low Temperature Storage	-40 °C	1000 h	11	
ESD (HBM)		R <sub>1</sub> : 10 MΩ R <sub>2</sub> : 1.5 kΩ C: 100 pF V: ±2 kV	5 times	30
ESD (MM)				
Vibration Test	20~2000~20 Hz, 200 m/s <sup>2</sup> , sweep 4 min X, Y, Z 3 direction, each 1 cycle	4 cycles	11	
Mechanical Shock Test	1500 g, 0.5 ms 3 shocks each X-Y-Z axis	5 cycles	11	

### b) Criteria for Judging the Damage

Item	Symbol	Test Condition (T <sub>s</sub> = 25 °C)	Limit	
			Min	Max
Forward Voltage	V <sub>F</sub>	I <sub>F</sub> = 150 mA	Init. Value * 0.9	Init. Value * 1.1
Luminous Flux	Φ <sub>v</sub>	I <sub>F</sub> = 150 mA	Init. Value * 0.7	Init. Value * 1.1

## 6. Soldering Conditions

### a) Reflow Conditions (Pb free)

Reflow frequency: 2 times max.

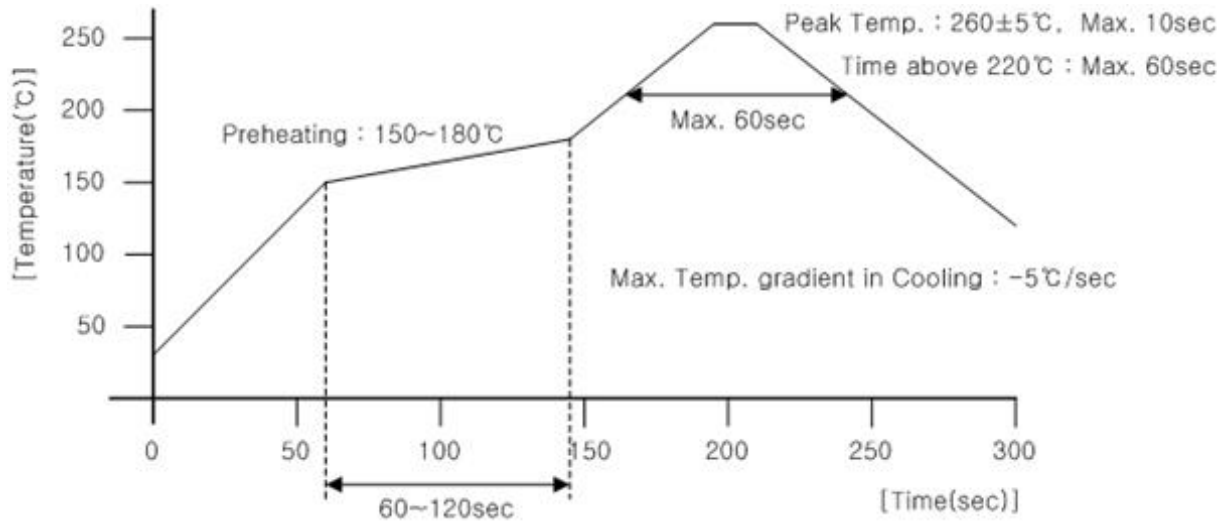

### b) Manual Soldering Conditions

Not more than 5 seconds @ max. 300 °C, under soldering iron.

## 7. Tape & Reel

### a) Taping Dimension

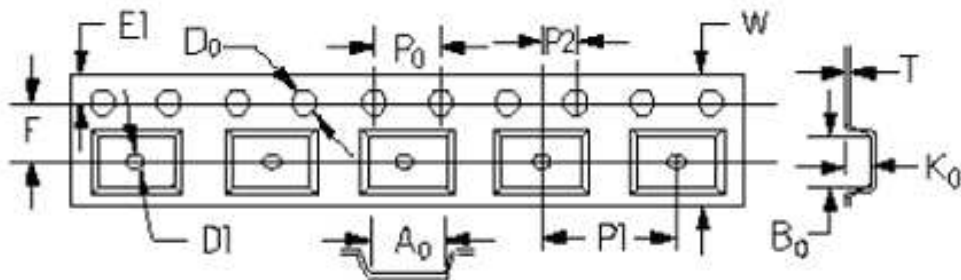

Ao	Bo	Ko	T	W	P1	E1	F	D0	D1	P2	Po	Po10
3.800	3.800	1.000	0.250	12.000	8.000	1.750	5.500	1.500	1.500	2.000	4.000	40.000

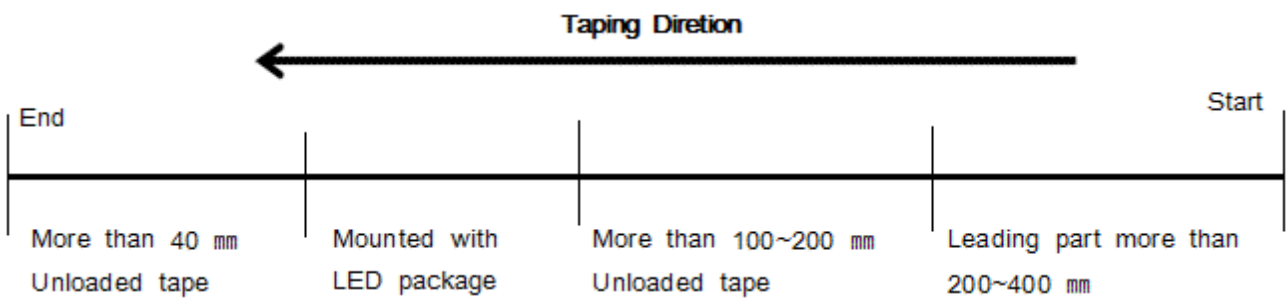

## b) Reel Dimension

(unit: mm)

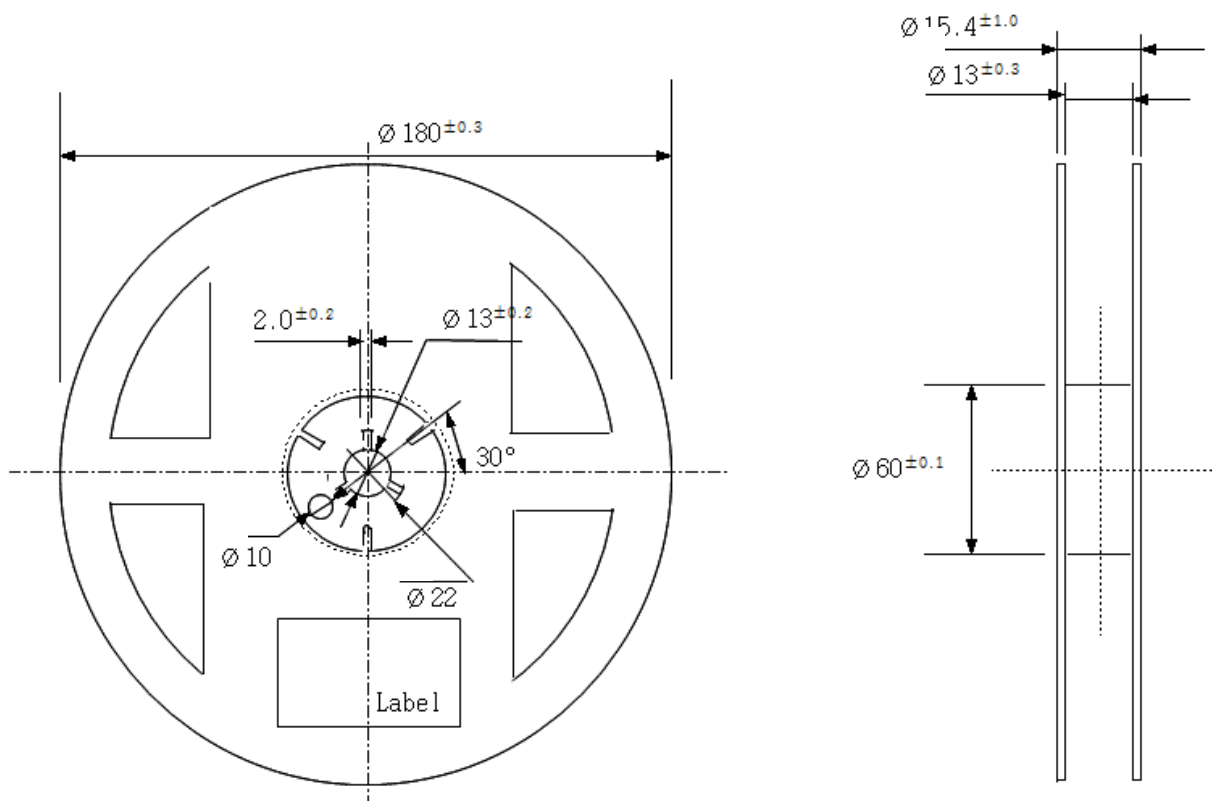
**Notes:**

- 1) Quantity: The quantity/reel is 1,000 pcs
- 2) Cumulative tolerance: Cumulative tolerance / 10 pitches is  $\pm 0.2$  mm
- 3) Adhesion strength of cover tape: Adhesion strength is 0.1-0.7 N when the cover tape is turned off from the carrier tape at  $10^{\circ}$  angle to the carrier tape
- 4) Packaging: P/N, Manufacturing data code no. and quantity are indicated on the aluminum packing bag



## 8. Label Structure

### a) Label Structure

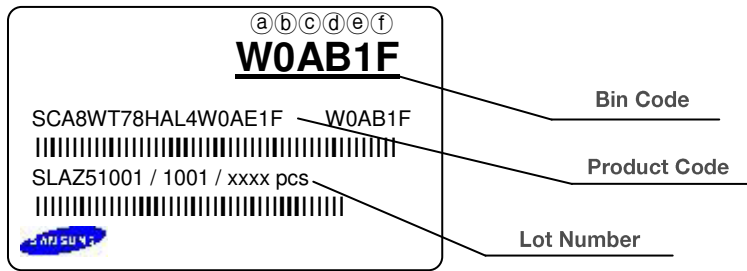

Note: Denoted bin code and product code above is only an example (see description on page 7)

Bin Code:

- ⒶⒷ: Forward Voltage bin (refer to page 10)
- ⒸⒹ: Chromaticity bin (refer to page 9)
- ⒺⒻ: Luminous Flux bin (refer to page 6-8)

### b) Lot Number

The lot number is composed of the following characters:

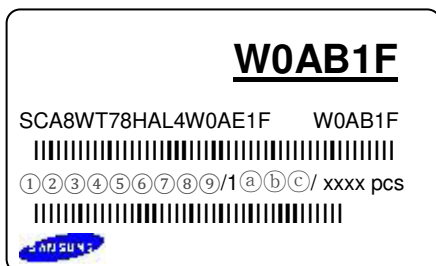

①②③④⑤⑥⑦⑧⑨ / 1ⒶⒷⒸ / xxxx pcs

- ① : Production site (S: Giheung, Korea)
- ② : L (LED)
- ③ : Product state (A: Normal, B: Bulk, C: First Production, R: Reproduction, S: Sample)
- ④ : Year (A: 2016, B:2017, C:2018...)
- ⑤ : Month (1~9, A, B, C)
- ⑥ : Day (1~9, A, B~V)
- ⑦⑧⑨ : Product serial number (001 ~ 999)
- ⒶⒷⒸ : Reel number (001 ~ 999)

## 9. Packing Structure

### a) Packing Process

Reel

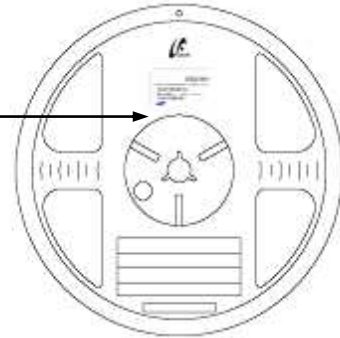
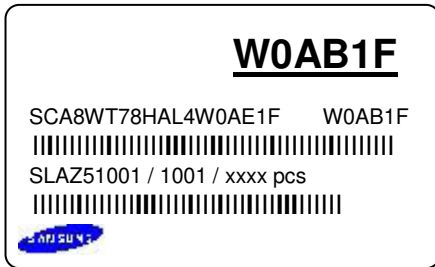

Aluminum Vinyl Packing Bag

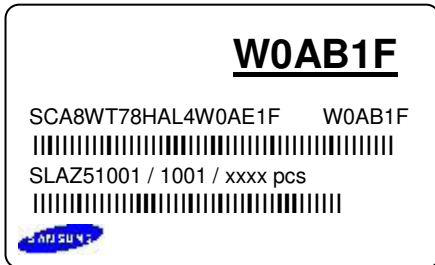

Outer Box

Material: Paper SW(B)

Type	Size (mm)			Note
	(a)	(b)	(c)	
7 inch	245 ± 5	220 ± 5	182 ± 5	Up to 7 reels

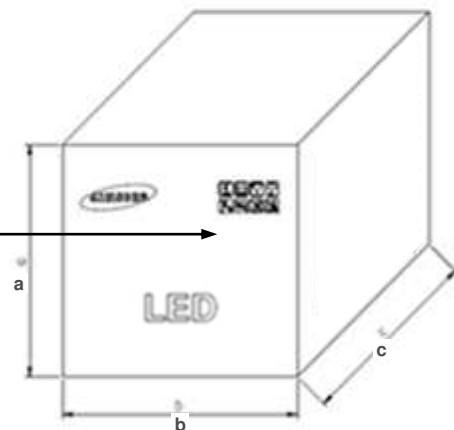
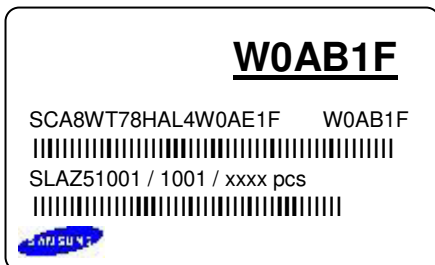

b) Aluminum Vinyl Packing Bag



**CAUTION**

This bag contains  
**MOISTURE SENSITIVE DEVICES**

**LEVEL**  
**2a**

1. Shelf life in sealed bag: 12 months at <40°C and <90% relative humidity (RH)
2. Peak package body temperature: 240 °C
3. After this bag is opened, devices that will be subjected to reflow solder or other high temperature processes must be:
  - a. Mounted within 672 hours at factory conditions of equal to or less than 30°C /60% RH, or
  - b. Stored at <10% RH
4. Devices require bake, before mounting, if:
  - a. Humidity Indicator Card is >65% when read at 23±5°C, or
  - b. 2a is not met.
5. If baking is required, devices must be baked for 1 hours at 60±5°C

Note: If device containers cannot be subjected to high temperature or shorter bake times are desired, reference IPC/JEDEC J-STD-033 for bake procedure.

Bag seal due date: \_\_\_\_\_  
(If blank, see code label)

Note: Level and body temperature by IPC/JEDEC J-STD-020

**W0AB1F**

SCA8WT78HAL4W0AE1F    W0AB1F  
 |||  
 SLAZ5001 / 1001 / xxxx pcs  
 |||

S A M S U N G



**ATTENTION**

OBserve PREcautions  
FOR HANDLING  
ELECTROSTATIC  
SENSITIVE  
DEVICES



**주의 사항**

이 알루미늄 지퍼 팩은 습기 및 정전기로부터 제품을 보호하기 위하여 제작되었습니다. 개봉 후에는 즉시 솔더 작업을 실시하는 것을 권장합니다.

습기 및 정전기로부터 제품을 보호 하기 위해서 개봉 후 사용하지 않는 자재는 본 팩에 넣어 보관 하시기 바랍니다. 사용하지 않는 자재를 본 팩에 넣을 때는 반드시 동봉된 드라이 팩과 함께 넣고 지퍼부분을 완전하게 밀봉하여 주시기 바랍니다.

**Important**

This Al Zipper bag is designed to protect the enclosed products from moisture and ESD. Once opened, the products should be soldered onto the printed circuit board immediately. When not in use, please do not leave the products unprotected by the Al Zipper Bag. To repack unused products., please ensure the zip-lock is completely sealed with the dry pack left inside.

c) Silica Gel & Humidity Indicator Card inside Aluminum Vinyl Bag



DESICCANT  
SILICA  
DO NOT  
GEL  
SIL

**HUMISAFE™**

**HUMIDITY INDICATOR COBALT-FREE**

10%	20%	30%	40%	50%	60%
					
READ AT TOP OF GREEN COLOR CHANGE BETWEEN YELLOW AND GREEN			Warning if Green Change Desiccant		GP&E Co., Ltd. 6CF-60NS

## 10. Precautions in Handling & Use

- 1) For over-current protection, users are recommended to apply resistors connected in series with the LEDs to mitigate sudden change of the forward current caused by shift of forward voltage.
- 2) This device should not be used in any type of fluid such as water, oil, organic solvent, etc. When cleaning is required, IPA is recommended as the cleaning agent. Some solvent-based cleaning agent may damage the silicone resins used in the device.
- 3) When the device is in operation, the forward current should be carefully determined considering the maximum ambient temperature and corresponding junction temperature.
- 4) LEDs must be stored in a clean environment. If the LEDs are to be stored for three months or more after being shipped from Samsung, they should be packed with a nitrogen-filled container (shelf life of sealed bags is 12 months at temperature 0~40 °C, 0~90 % RH).
- 5) After storage bag is opened, device subjected to soldering, solder reflow, or other high temperature processes must be:
  - a. Mounted within 672 hours (28 days) at an assembly line with a condition of no more than 30 °C / 60 % RH, or
  - b. Stored at <10 % RH
- 6) Repack unused devices with anti-moisture packing, fold to close any opening and then store in a dry place.
- 7) Devices require baking before mounting, if humidity card reading is >60 % at 23 ± 5 °C.
- 8) Devices must be baked for 1 hour at 60 ± 5 °C, if baking is required.
- 9) The LEDs are sensitive to the static electricity and surge current. It is recommended to use a wrist band or anti-electrostatic glove when handling the LEDs. If voltage exceeding the absolute maximum rating is applied to LEDs, it may cause damage or even destruction to LED devices. Damaged LEDs may show some unusual characteristics such as increase in leakage current, lowered turn-on voltage, or abnormal lighting of LEDs at low current.
- 10) VOCs (Volatile Organic Compounds) can be generated from adhesives, flux, hardener or organic additives used in luminaires (fixtures). Transparent LED silicone encapsulant is permeable to those chemicals and they may lead to a discoloration of encapsulant when they exposed to heat or light. This phenomenon can cause a significant loss of light emitted (output) from the luminaires. In order to prevent these problems, we recommend users to know the physical properties of materials used in luminaires and they must be carefully selected.
- 11) Risk of sulfurization (or tarnishing)

The LED from Samsung uses a silver-plated lead frame and its surface color may change to black (or dark colored) when it is exposed to sulfur (S), chlorine (Cl) or other halogen compound. Sulfurization of lead frame may cause intensity degradation, change of chromaticity coordinates and, in extreme cases, open circuit. It requires caution. Due to possible sulfurization of lead frame, LED should not be used and stored together with oxidizing substances made of materials such as rubber, plain paper, lead solder cream, etc.