



Chipsmall Limited consists of a professional team with an average of over 10 year of expertise in the distribution of electronic components. Based in Hongkong, we have already established firm and mutual-benefit business relationships with customers from,Europe,America and south Asia,supplying obsolete and hard-to-find components to meet their specific needs.

With the principle of “Quality Parts,Customers Priority,Honest Operation,and Considerate Service”,our business mainly focus on the distribution of electronic components. Line cards we deal with include Microchip,ALPS,ROHM,Xilinx,Pulse,ON,Everlight and Freescale. Main products comprise IC,Modules,Potentiometer,IC Socket,Relay,Connector.Our parts cover such applications as commercial,industrial, and automotives areas.

We are looking forward to setting up business relationship with you and hope to provide you with the best service and solution. Let us make a better world for our industry!



## Contact us

Tel: +86-755-8981 8866 Fax: +86-755-8427 6832

Email & Skype: info@chipsmall.com Web: www.chipsmall.com

Address: A1208, Overseas Decoration Building, #122 Zhenhua RD., Futian, Shenzhen, China



TABLE 1	
PART NUMBER	"B"
SCRUS-10-X-XX-XX-MBS-MB	16.0 [.63]
SCRUS-10-X-XX-XX-MBS-AM	25.0 [.98]
SCRUS-10-X-XX-XX-MBS-BC	20.0 [.79]
SCRUS-10-X-XX-XX-MBS-BM	25.0 [.98]

DO NOT SCALE FROM THIS PRINT

SCRUS-10-X-XX.XX-XXX-XX

**PLATING**  
-G: .000030" GOLD ON CONTACT AREAS, NICKEL ON SHELLS

**LENGTH**  
-XX.XX  
(0.25M[9.842] MIN - 50.00M[1968.504] MAX)

**END 2 OPTIONS**  
-MB: MINI USB B TYPE PLUG NOT SEALED (THIS END NOT SEALED ONLY)  
-BC: BLUNT CUT END (SEE SHEET 5)  
-AM: USB A TYPE PLUG NOT SEALED (THIS END NOT SEALED ONLY)  
-BM: USB B TYPE PLUG NOT SEALED (THIS END NOT SEALED ONLY)

**END 1 OPTIONS**  
-MBS: MINI USB B TYPE RECEPTACLE SEALED (THIS END SEALED ONLY)

DESIGNED & DIMENSIONED IN MILLIMETERS [INCHES]

FIG 1  
SCRUS-10-X-XX.XX-MBS-MB SHOWN

**NOTE:** - 00.25 AND - 00.50 ARE CATALOG STANDARD LENGTHS. FOR OTHER LENGTHS CONTACT SAMTEC.

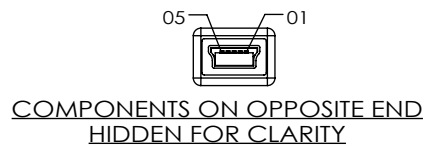
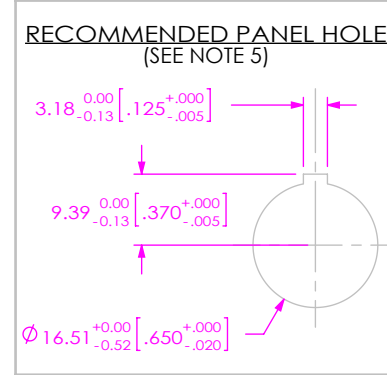
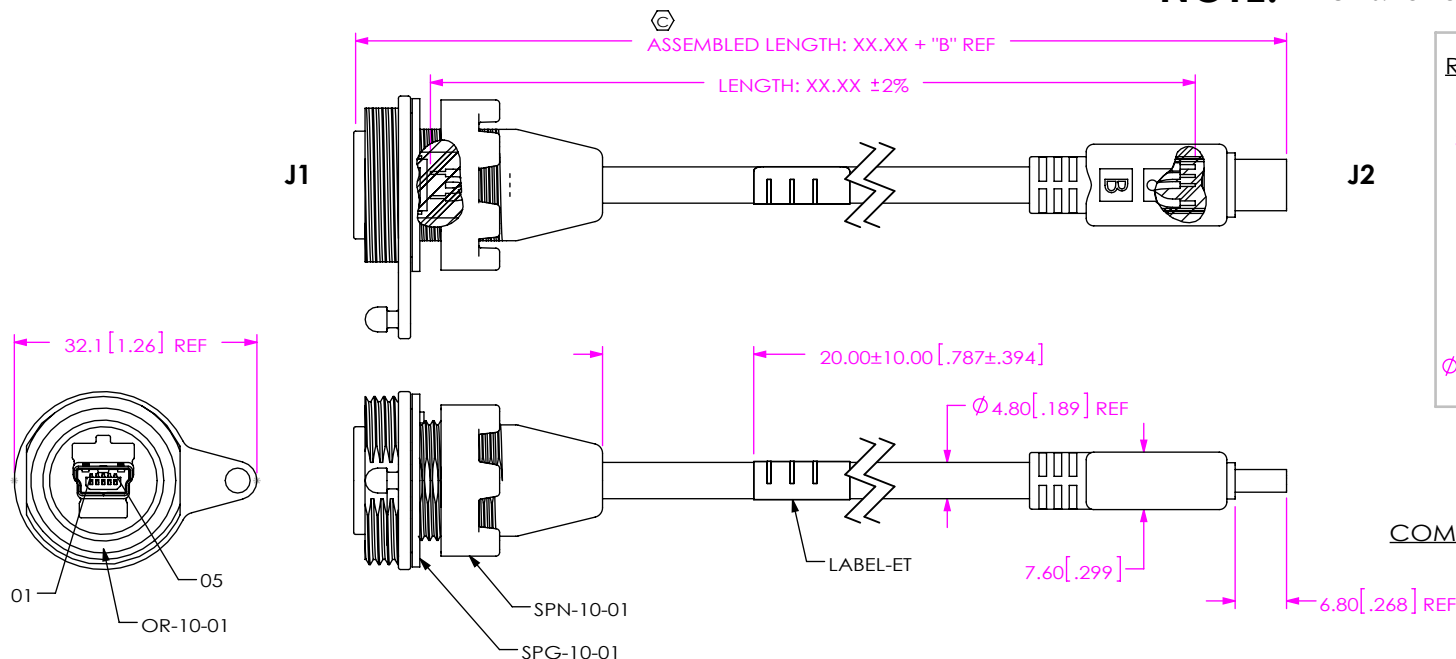

- NOTES:
- ⊕ REPRESENTS A CRITICAL DIMENSION.
  - ⊕ ASSEMBLY TO BE 100% TESTED FOR OPENS AND SHORTS. HIGH POT TESTED AT 200V BEFORE PREMOLD IN-PROCESS AND ON FINISHED ASSEMBLY. LABEL EACH ASSEMBLY WITH 1 LABEL-ET.
  - NOTE DELETED
  - USB LOGO TO BE RAISED 0.25 [.010].
  - PANEL THICKNESS: 0.76 [.030] - 5.21 [.205].
  - ASSEMBLY TO BE BULK PACKAGED.
  - TORQUE SPECIFICATION FOR SPN-10-01 IS 12 IN-LB.
  - NOTE DELETED.
  - ALL IDENTIFICATION MARKS MUST NOT STAND GREATER THAN 0.051 [.002] OFF THE SURFACE OF THE PART.
  - NOTE DELETED.
  - ALL EJECTOR PIN AND GATE LOCATIONS MUST BE APPROVED BY SAMTEC PRODUCT ENGINEERING.
  - ANY ADDITIONAL VOIDING AND/OR MODIFICATIONS TO VOIDING MUST BE APPROVED BY SAMTEC PRODUCT ENGINEERING.
  - NOTE DELETED.
  - NOTE DELETED.
  - PART MUST SCREW INTO SAMTEC PART # SCN-10-01
  - PART MUST SCREW INTO SAMTEC PART # SPN-10-01
  - THIS IS A COMPONENT OF USBP-A-01-G-B-01 (CALLED OUT ON THE BOM), BUT LABELED INDIVIDUALLY FOR ASSEMBLY PURPOSES.
  - LENGTHS GREATER THAN 0.50 M ARE NOT SUPPORTED BY USB 2.0 TEST DATA.
  - THIS IS A COMPONENT OF USBP-B-01-G-B-01 (CALLED OUT ON THE BOM), BUT LABELED INDIVIDUALLY FOR ASSEMBLY PURPOSES.
  - REFER TO MD-XXX-XX-XXXX-XX FOR SAMTEC MATERIAL PART NUMBER.

**THIS PRODUCT MANUFACTURED WITH LEAD-FREE PROCESSING**

<p><b>UNLESS OTHERWISE SPECIFIED, DIMENSIONS ARE IN MILLIMETERS.</b></p> <p>TOLERANCES ARE:</p> <table border="0"> <tr> <td>DECIMALS</td> <td>ANGLES</td> </tr> <tr> <td>X.X: ±0.35 [.013]</td> <td>2°</td> </tr> <tr> <td>X.XX: ±0.25 [.010]</td> <td></td> </tr> <tr> <td>X.XXX: ±0.15 [.006]</td> <td></td> </tr> </table>	DECIMALS	ANGLES	X.X: ±0.35 [.013]	2°	X.XX: ±0.25 [.010]		X.XXX: ±0.15 [.006]		<p><b>PROPRIETARY NOTE</b></p> <p>THIS DOCUMENT CONTAINS CONFIDENTIAL AND PROPRIETARY INFORMATION AND ALL DESIGN, MANUFACTURING, REPRODUCTION, USE, PATENT RIGHTS AND SALES RIGHTS ARE EXPRESSLY RESERVED BY SAMTEC, INC. THIS DOCUMENT SHALL NOT BE DISCLOSED, IN WHOLE OR PART, TO ANY UNAUTHORIZED PERSON OR ENTITY NOR REPRODUCED, TRANSFERRED OR INCORPORATED IN ANY OTHER PROJECT IN ANY MANNER WITHOUT THE EXPRESS WRITTEN CONSENT OF SAMTEC, INC.</p>	<p><b>520 PARK EAST BLVD, NEW ALBANY, IN 47150</b>                  PHONE: 812-944-6733 FAX: 812-948-5047                  e-Mail: info@SAMTEC.com code: 55322</p>
DECIMALS	ANGLES									
X.X: ±0.35 [.013]	2°									
X.XX: ±0.25 [.010]										
X.XXX: ±0.15 [.006]										
<p><b>MATERIAL:</b></p> <p>INSULATOR: GLASS FILLED THERMOPLASTIC                  CONTACTS: COPPER ALLOY, SHIELDS: CRS                  CABLE NUT: PA66                  SEALED PREMOLD: RITFLEX 640-RD30565P62-BLACK, SHOT WEIGHT: 9.07g[.020lb]                  SEALED OVERMOLD: ZYTEL PA70G13L 52-91908BK5; MAX REGRIND: 10%, SHOT WEIGHT: 10.43g[.023lb]                  NON-SEALED OVERMOLD: PVC ALP-411-75-BK-2885; MAX REGRIND: 30%, SHOT WEIGHT: 6.80g[.015lb]</p>	<p>DO NOT SCALE DRAWING SHEET SCALE: 0.75:1</p> <p>MAX FLASH ALLOWED: 0.05[.002]                  MAX GATE VESTIGE: 0.05[.002]</p>	<p>DESCRIPTION:                  PANEL MOUNT SEALED MINI USB CABLE</p> <p>DWG. NO.                  SCRUS-10-X-XX.XX-XXX-XX</p> <p>BY: B. PERRY 09-01-2010 SHEET 1 OF 10</p>								

FIG 2  
SCRUS-10-X-XX.XX-MBS-BC SHOWN  
(SAME AS FIG 1 UNLESS OTHERWISE STATED)

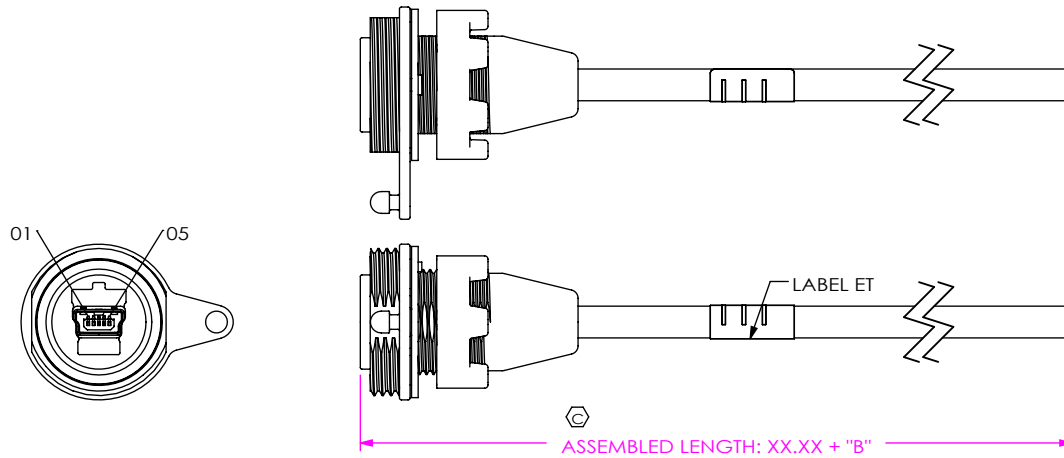

FIG 3  
SCRUS-10-X-XX.XX-MBS-AM SHOWN  
(SAME AS FIG 1 UNLESS OTHERWISE STATED)

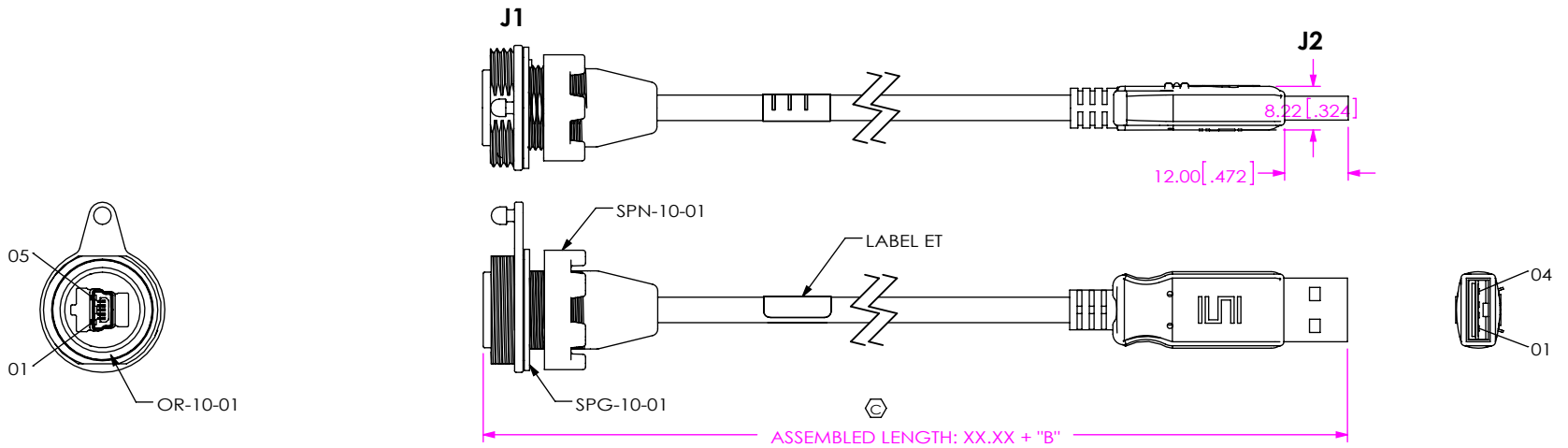

TABLE 3: PIN-OUT

J1 End	Wire Color	J2 End			
-MBS		-MB	-BC	-AM	-BM
01	RED	01	01	01	01
02	WHITE	02	02	02	02
03	GREEN	03	03	03	03
04	NOT CONNECTED	04	04	n/a	n/a
05	BLACK	05	05	04	04
USB Shield	DRAIN/CABLE SHIELD	USB Shield	USB Shield	USB Shield	USB Shield

**PROPRIETARY NOTE**  
THIS DOCUMENT CONTAINS CONFIDENTIAL AND PROPRIETARY INFORMATION AND ALL DESIGN, MANUFACTURING, REPRODUCTION, USE, PATENT RIGHTS AND SALES RIGHTS ARE EXPRESSLY RESERVED BY SAMTEC, INC. THIS DOCUMENT SHALL NOT BE DISCLOSED, IN WHOLE OR PART, TO ANY UNAUTHORIZED PERSON OR ENTITY NOR REPRODUCED, TRANSFERRED OR INCORPORATED IN ANY OTHER PROJECT IN ANY MANNER WITHOUT THE EXPRESS WRITTEN CONSENT OF SAMTEC, INC.

DO NOT SCALE DRAWING

SHEET SCALE: 0.75:1



520 PARK EAST BLVD, NEW ALBANY, IN 47150  
PHONE: 812-944-6733 FAX: 812-948-5047  
e-Mail: info@SAMTEC.com code: 55322

DESCRIPTION:  
PANEL MOUNT SEALED MINI USB CABLE

DWG. NO.  
SCRUS-10-X-XX.XX-XXX-XX

BY: B. PERRY 09-01-2010 SHEET 2 OF 10

REVISION W

-MBS -MB END OPTIONS  
IN-PROCESS 1  
 CUT CABLES TO LENGTH & STRIP OUTER JACKET TO DIMENSION SHOWN

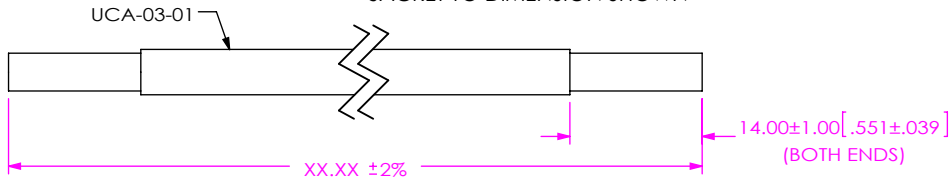

-MBS -MB END OPTIONS  
IN-PROCESS 2  
 TWIST SHIELD & TRIM INDIVIDUAL WIRES TO DIM SHOWN

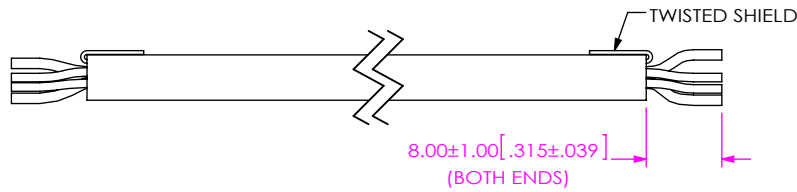

-MBS -MB END OPTIONS  
IN-PROCESS 3  
 STRIP INDIVIDUAL WIRES TO DIMENSION SHOWN

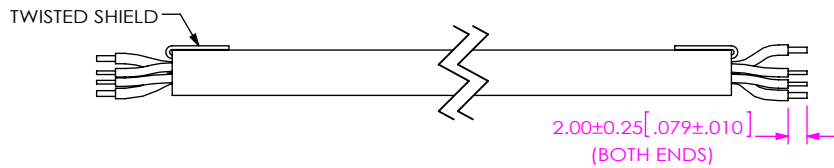

-MBS -MB END OPTIONS  
IN-PROCESS 4  
 TERMINATE TO MUSB-05-G-B-C & SUB-MUSBP-05-B-G-C

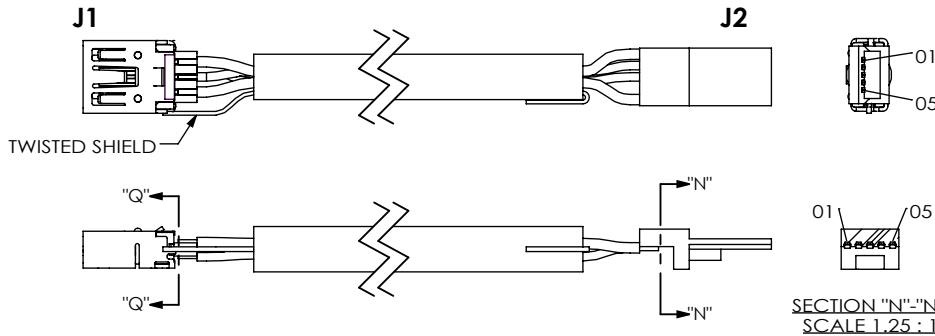

SECTION "Q"-"Q"  
 SCALE 2:1

SECTION "N"-"N"  
 SCALE 1.25:1

SOLDER SHIELD IN THIS AREA  
 1.25 [.049] MAX

(CABLES NOT SHOWN FOR CLARITY)  
 (SEE PINOUT TABLE)

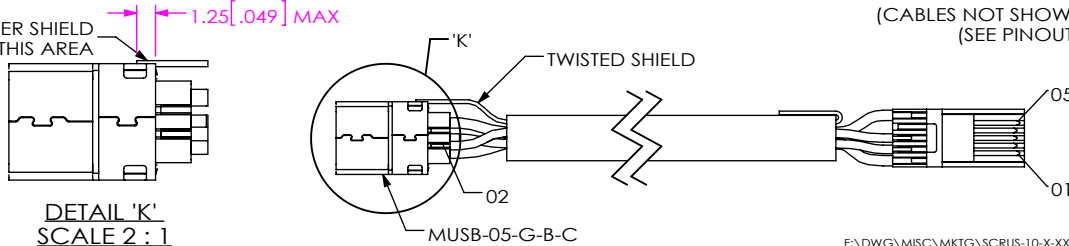

DETAIL 'K'  
 SCALE 2:1

F:\DWG\MISC\MKTG\SCRUS-10-X-XX.XX-XXX-XX-MKT.SLDDRW

-MBS -MB END OPTIONS  
IN-PROCESS 5  
 ADD MUSBS-05-B-N-01

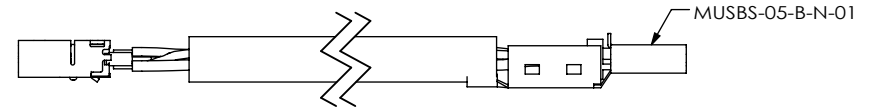

-MBS -MB END OPTIONS  
IN-PROCESS 6  
 ADD MUSBS-05-B-N-02

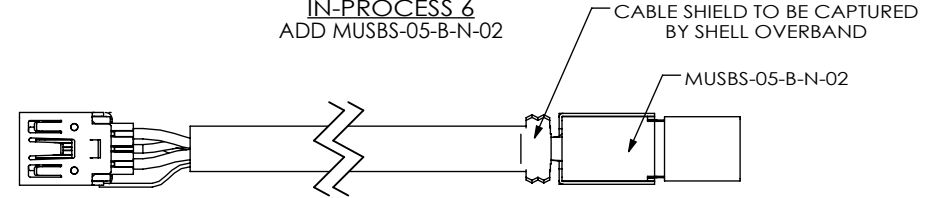

-MBS -MB END OPTIONS  
IN-PROCESS 7  
 CRIMP SHELLS OVERBAND & ADD TRIM EXCESS SHIELD



-MBS -MB END OPTIONS  
IN-PROCESS 8  
 ADD PREMOLD

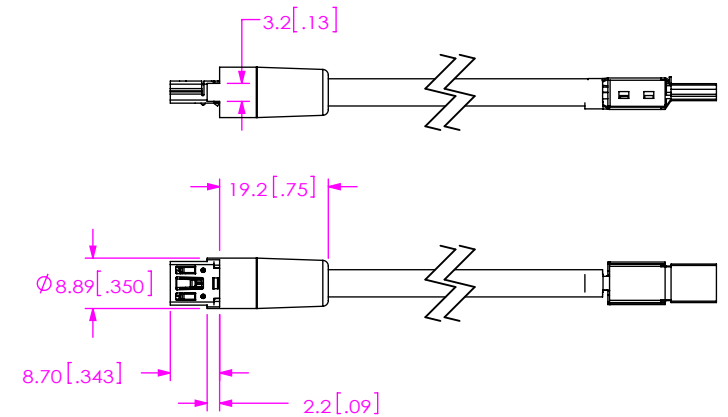

**PROPRIETARY NOTE**  
 THIS DOCUMENT CONTAINS CONFIDENTIAL AND PROPRIETARY INFORMATION AND ALL DESIGN, MANUFACTURING, REPRODUCTION, USE, PATENT RIGHTS AND SALES RIGHTS ARE EXPRESSLY RESERVED BY SAMTEC, INC. THIS DOCUMENT SHALL NOT BE DISCLOSED, IN WHOLE OR PART, TO ANY UNAUTHORIZED PERSON OR ENTITY NOR REPRODUCED, TRANSFERRED OR INCORPORATED IN ANY OTHER PROJECT IN ANY MANNER WITHOUT THE EXPRESS WRITTEN CONSENT OF SAMTEC, INC.

DO NOT SCALE DRAWING  
 SHEET SCALE: 0.75:1



520 PARK EAST BLVD, NEW ALBANY, IN 47150  
 PHONE: 812-944-6733 FAX: 812-948-5047  
 e-Mail: info@SAMTEC.com code: 55322

DESCRIPTION:  
 PANEL MOUNT SEALED MINI USB CABLE  
 DWG. NO.  
**SCRUS-10-X-XX.XX-XXX-XX**  
 BY: B. PERRY 09-01-2010 SHEET 3 OF 10

-MBS -MB END OPTIONS  
IN-PROCESS 9  
OVERMOLD SEALED CIRCULAR END

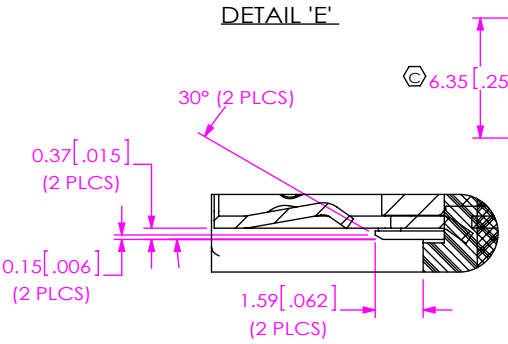
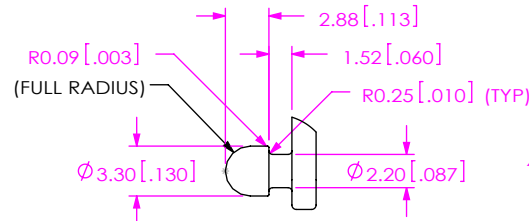
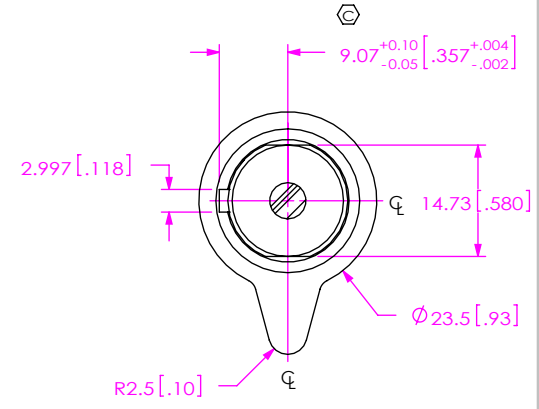
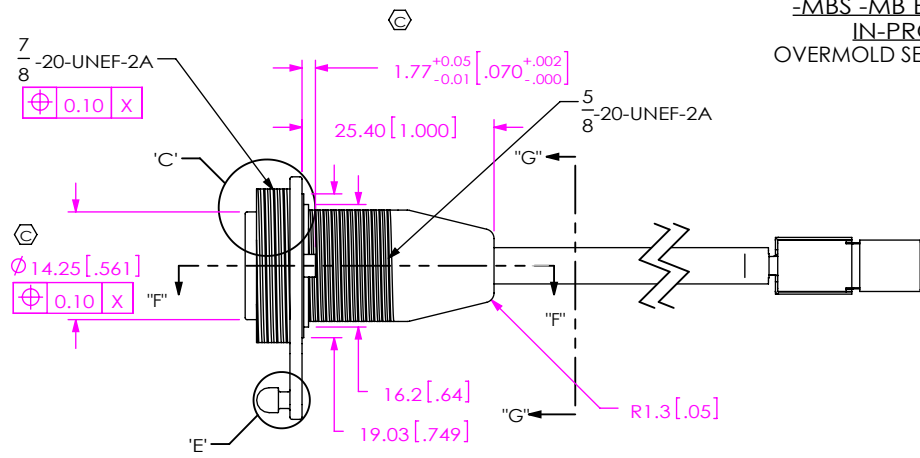
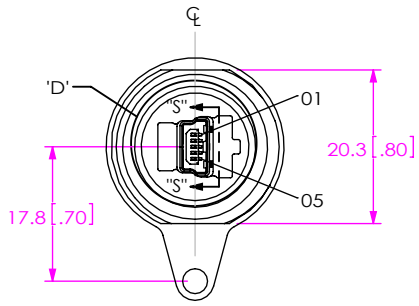

SCALE 4:1

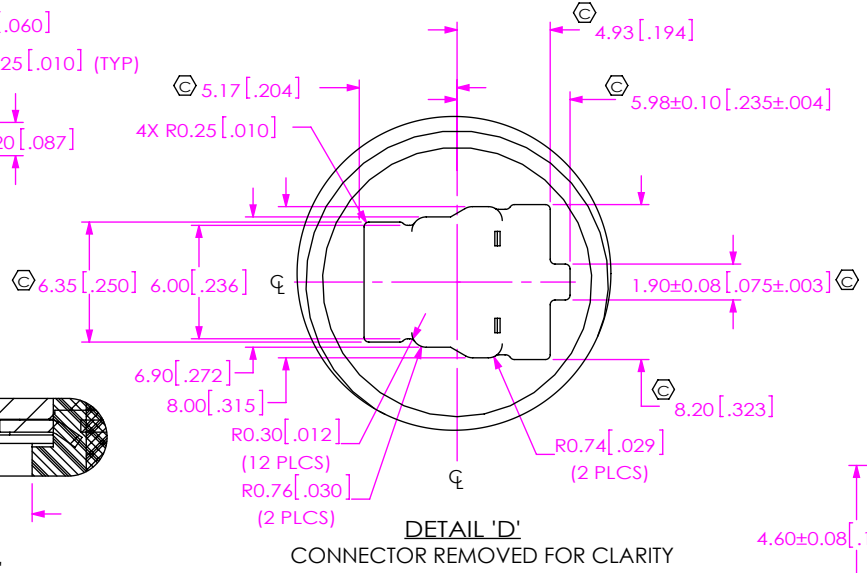

CONNECTOR REMOVED FOR CLARITY

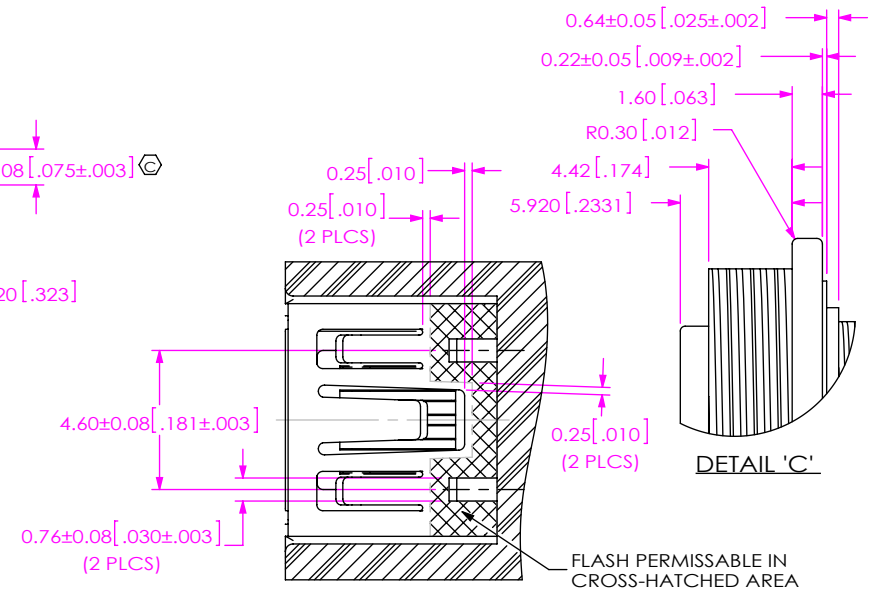

SCALE 4:1

FLASH PERMISSIBLE IN CROSS-HATCHED AREA

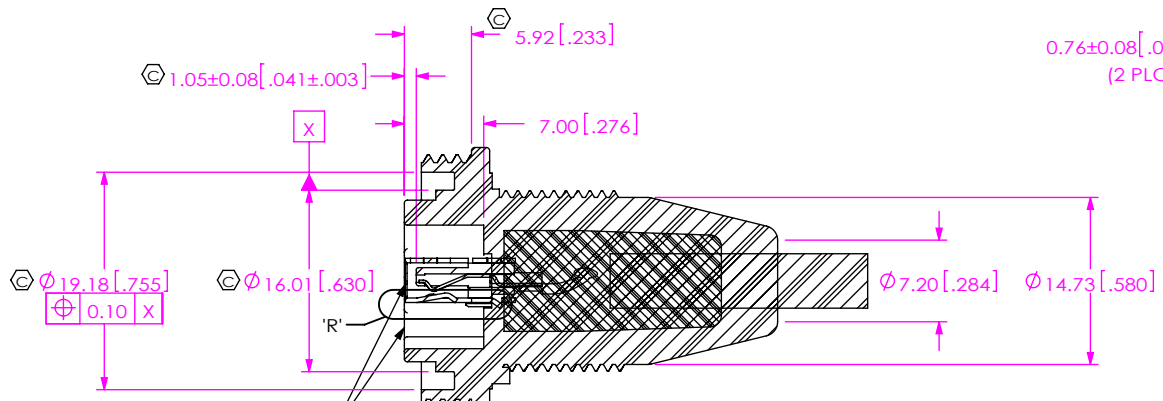

SCALE 1.5:1

CONNECTOR HOUSING MAY EXTEND OUTSIDE OF OVER-MOLD OR BE RECESSED INTO OVER-MOLD BY 0.25 [0.010] MAX.

**PROPRIETARY NOTE**  
THIS DOCUMENT CONTAINS CONFIDENTIAL AND PROPRIETARY INFORMATION AND ALL DESIGN, MANUFACTURING, REPRODUCTION, USE, PATENT RIGHTS AND SALES RIGHTS ARE EXPRESSLY RESERVED BY SAMTEC, INC. THIS DOCUMENT SHALL NOT BE DISCLOSED, IN WHOLE OR PART, TO ANY UNAUTHORIZED PERSON OR ENTITY NOR REPRODUCED, TRANSFERRED OR INCORPORATED IN ANY OTHER PROJECT IN ANY MANNER WITHOUT THE EXPRESS WRITTEN CONSENT OF SAMTEC, INC.

DO NOT SCALE DRAWING  
SHEET SCALE: 0.75:1



520 PARK EAST BLVD, NEW ALBANY, IN 47150  
PHONE: 812-944-6733 FAX: 812-948-5047  
e-Mail: info@SAMTEC.com code: 55322

DESCRIPTION:	PANEL MOUNT SEALED MINI USB CABLE
DWG. NO.	SCRUS-10-X-XX.XX-XXX-XX
BY:	B. PERRY 09-01-2010 SHEET 4 OF 10

-MBS -MB END OPTIONS  
IN-PROCESS 10  
OVERMOLD UNSEALED END

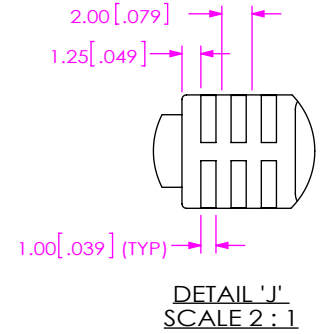
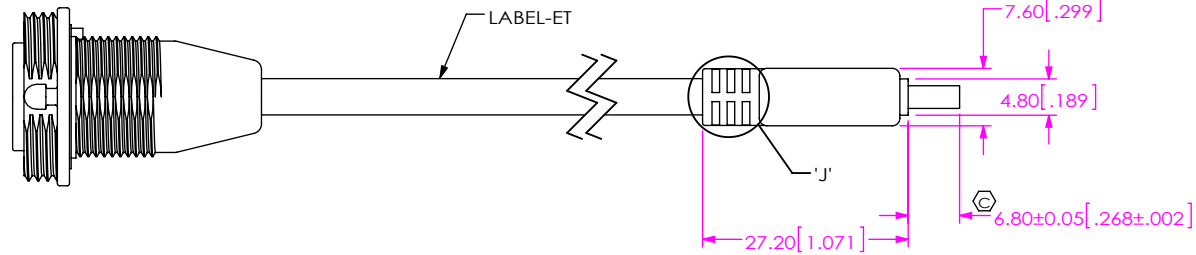
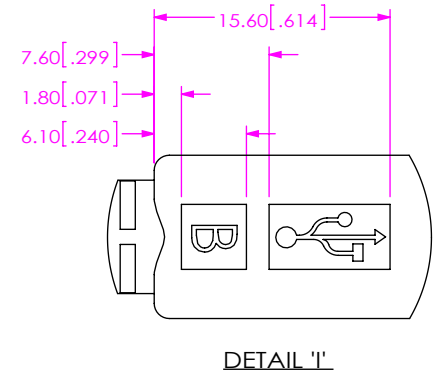
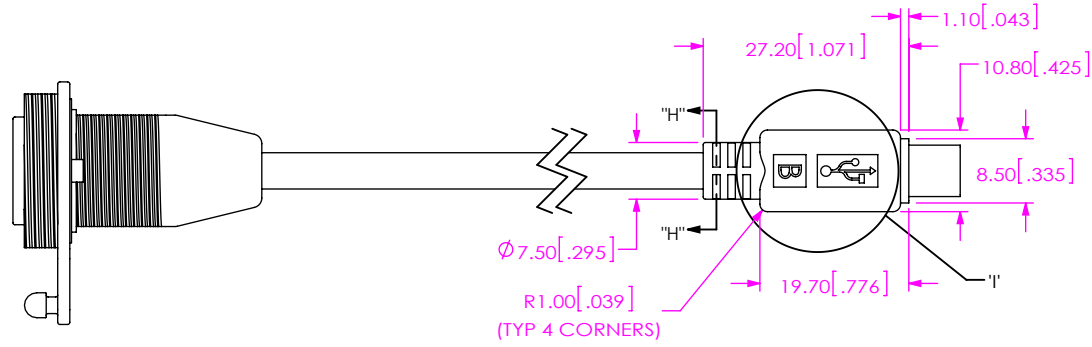
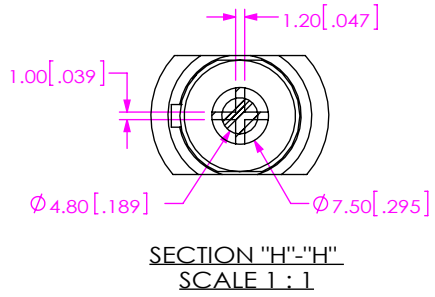

-MBS -MB END OPTIONS  
IN-PROCESS 11  
ADD SPG-10-01 & SPN-10-01 & OR-10-01

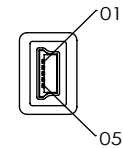
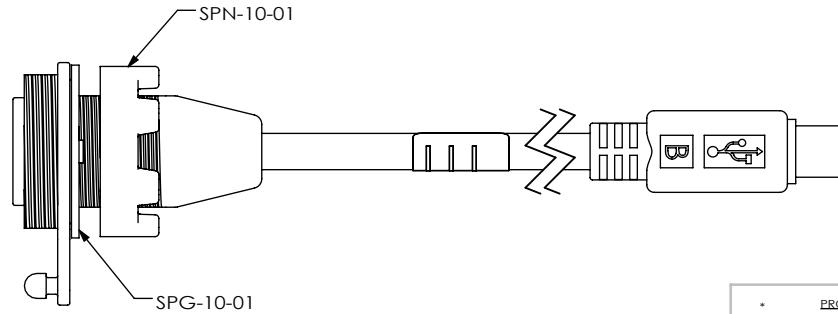
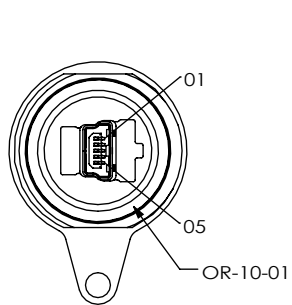

**PROPRIETARY NOTE**  
THIS DOCUMENT CONTAINS CONFIDENTIAL AND PROPRIETARY INFORMATION AND ALL DESIGN, MANUFACTURING, REPRODUCTION, USE, PATENT RIGHTS AND SALES RIGHTS ARE EXPRESSLY RESERVED BY SAMTEC, INC. THIS DOCUMENT SHALL NOT BE DISCLOSED, IN WHOLE OR IN PART, TO ANY UNAUTHORIZED PERSON OR ENTITY NOR REPRODUCED, TRANSFERRED OR INCORPORATED IN ANY OTHER PROJECT IN ANY MANNER WITHOUT THE EXPRESS WRITTEN CONSENT OF SAMTEC, INC.

DO NOT SCALE DRAWING

SHEET SCALE: 0.75:1

**samtec**

520 PARK EAST BLVD, NEW ALBANY, IN 47150  
PHONE: 812-944-6733 FAX: 812-948-5047  
e-Mail: info@SAMTEC.com code: 55322

DESCRIPTION:  
PANEL MOUNT SEALED MINI USB CABLE

DWG. NO.  
**SCRUS-10-X-XX.XX-XXX-XX**

BY: B. PERRY 09-01-2010 SHEET 5 OF 10

**-MBS -BC END OPTIONS**  
**IN-PROCESS 1**  
 CUT CABLES TO LENGTH & STRIP OUTER JACKET TO DIMENSION SHOWN

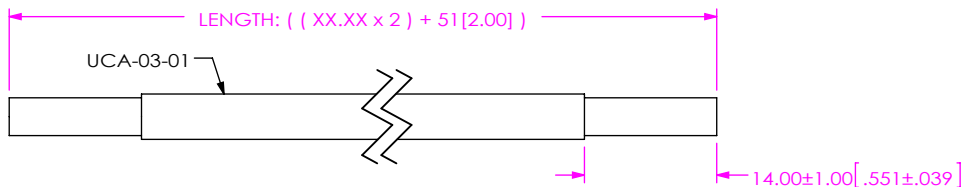

**-MBS -BC END OPTIONS**  
**IN-PROCESS 2**  
 TRIM WIRES TO LENGTH & TWIST SHIELD

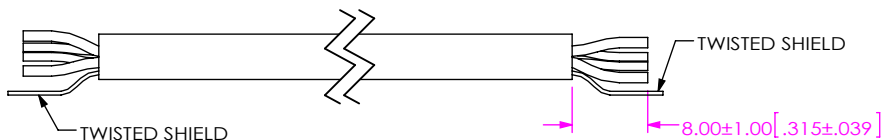

**-MBS -BC END OPTIONS**  
**IN-PROCESS 3**  
 STRIP INDIVIDUAL WIRES TO DIMENSION SHOWN

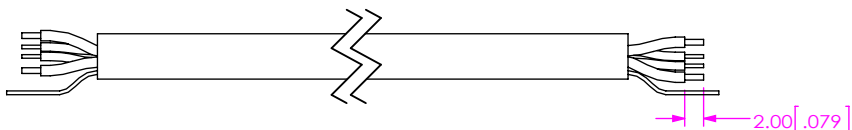

**-MBS -BC END OPTIONS**  
**IN-PROCESS 4**  
 TERMINATE TO MUSB-05-G-B-C

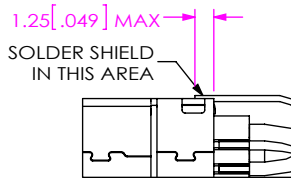
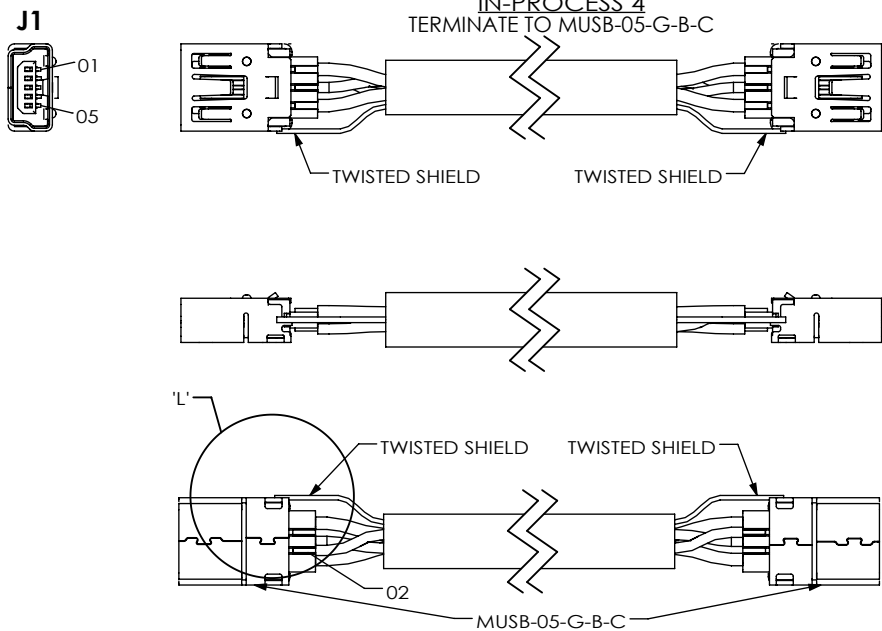

**DETAIL 'L'**  
**SCALE 2 : 1**

**-MBS -BC END OPTIONS**  
**IN-PROCESS 5**  
 ADD PREMOLD, SAME AS -MBS -MB IN-PROCESS 8

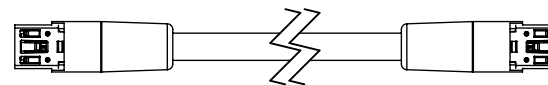

**-MBS -BC END OPTIONS**  
**IN-PROCESS 6**  
 ADD OVERMOLD, SAME AS -MBS -MB IN-PROCESS 9

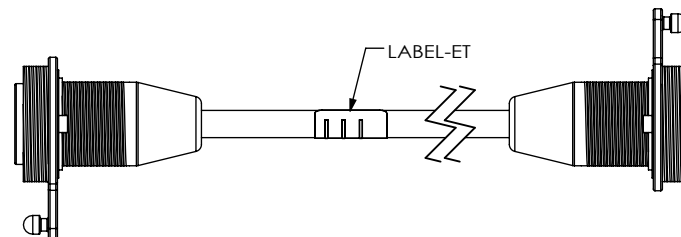

**-MBS -BC END OPTIONS**  
**IN-PROCESS 7**  
 CUT IN HALF AND TRIM TO LENGTH  
 ADD SPN-10-01, SPG-10-01, & OR-10-01

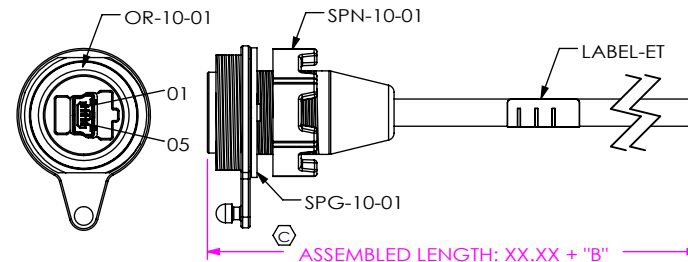

**PROPRIETARY NOTE**

THIS DOCUMENT CONTAINS CONFIDENTIAL AND PROPRIETARY INFORMATION AND ALL DESIGN, MANUFACTURING, REPRODUCTION, USE, PATENT RIGHTS AND SALES RIGHTS ARE EXPRESSLY RESERVED BY SAMTEC, INC. THIS DOCUMENT SHALL NOT BE DISCLOSED, IN WHOLE OR PART, TO ANY UNAUTHORIZED PERSON OR ENTITY NOR REPRODUCED, TRANSFERRED OR INCORPORATED IN ANY OTHER PROJECT IN ANY MANNER WITHOUT THE EXPRESS WRITTEN CONSENT OF SAMTEC, INC.

SHEET SCALE: 0.75:1

DO NOT SCALE DRAWING



520 PARK EAST BLVD, NEW ALBANY, IN 47150  
 PHONE: 812-944-6733 FAX: 812-948-5047  
 e-Mail: info@SAMTEC.com code: 55322

DESCRIPTION:  
 PANEL MOUNT SEALED MINI USB CABLE

DWG. NO.  
**SCRUS-10-X-XX.XX-XXX-XX**

BY: B. PERRY 09-01-2010 SHEET 6 OF 10

**-MBS -AM END OPTION  
IN-PROCESS 1  
STRIP OUTER JACKET TO DIMENSION SHOWN**

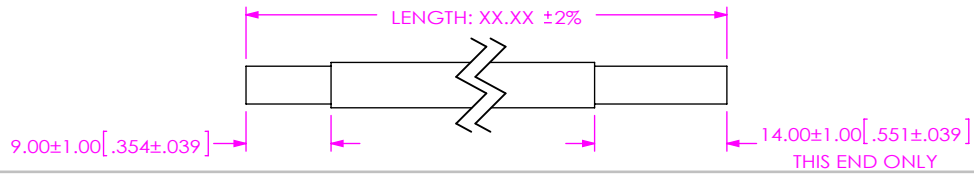

**-MBS -AM END OPTION  
IN-PROCESS 2  
TWIST SHIELD & TRIM INDIVIDUAL WIRES**

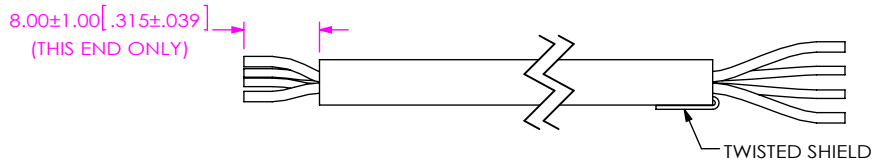

**-MBS -AM END OPTION  
IN-PROCESS 3  
STRIP INDIVIDUAL WIRES TO DIMENSION SHOWN**

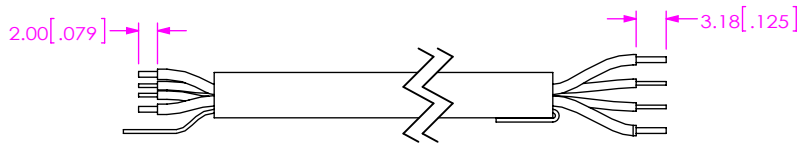

**-MBS -AM END OPTION  
IN-PROCESS 4  
TERMINATE TO MUSB-05-G-B-C & SUB-USB-A-X-B-XX  
(SEE NOTE 17)**

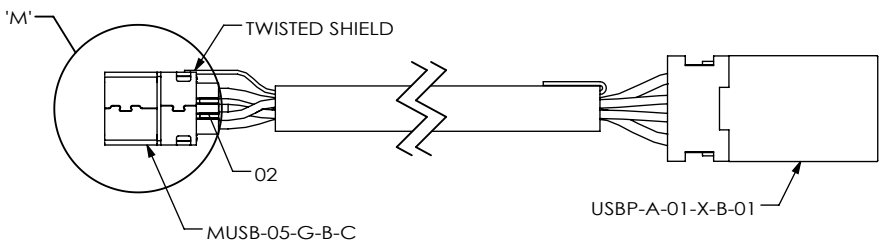
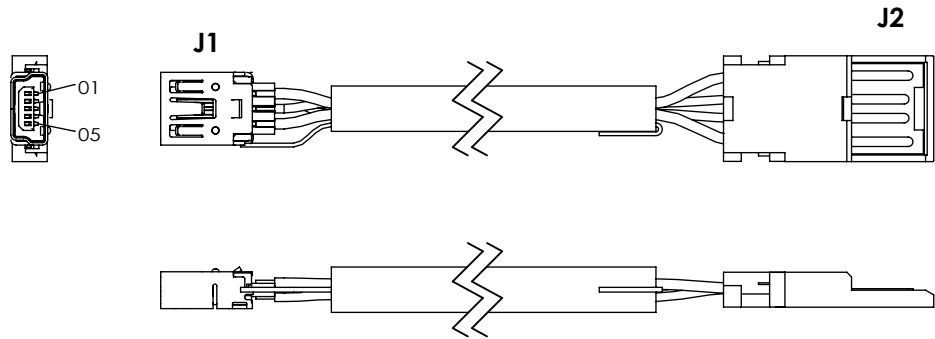

**-MBS -AM END OPTION  
IN-PROCESS 5  
ADD USBS-A-X-01-XX (SEE NOTE 17)**

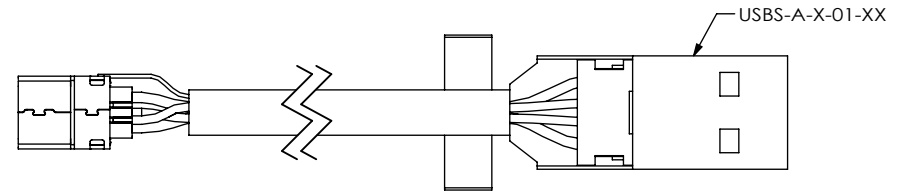

**-MBS -AM END OPTION  
IN-PROCESS 6  
ADD USBS-A-X-02-XX (SEE NOTE 17)**

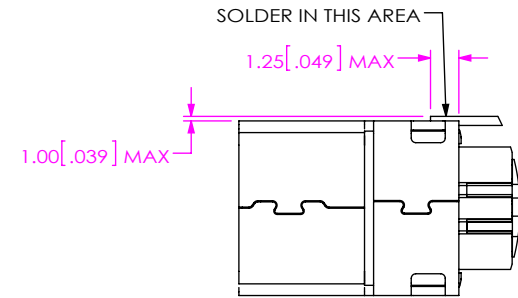
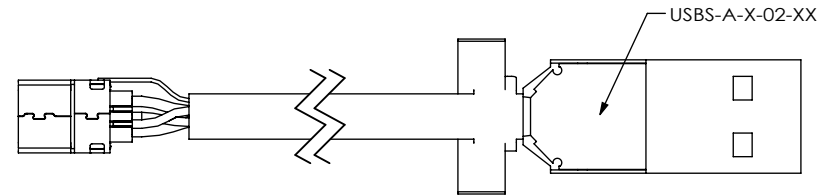

**DETAIL 'M'  
SCALE 3 : 1**

**PROPRIETARY NOTE**  
THIS DOCUMENT CONTAINS CONFIDENTIAL AND PROPRIETARY INFORMATION AND ALL DESIGN, MANUFACTURING, REPRODUCTION, USE, PATENT RIGHTS AND SALES RIGHTS ARE EXPRESSLY RESERVED BY SAMTEC, INC. THIS DOCUMENT SHALL NOT BE DISCLOSED, IN WHOLE OR PART, TO ANY UNAUTHORIZED PERSON OR ENTITY NOR REPRODUCED, TRANSFERRED OR INCORPORATED IN ANY OTHER PROJECT IN ANY MANNER WITHOUT THE EXPRESS WRITTEN CONSENT OF SAMTEC, INC.

DO NOT SCALE DRAWING

SHEET SCALE: 1:5



520 PARK EAST BLVD, NEW ALBANY, IN 47150  
PHONE: 812-944-6733 FAX: 812-948-5047  
e-Mail: info@SAMTEC.com code: 55322

DESCRIPTION:  
PANEL MOUNT SEALED MINI USB CABLE

DWG. NO.  
**SCRUS-10-X-XX.XX-XXX-XX**

BY: B. PERRY 09-01-2010 SHEET 7 OF 10



-MBS -AM END OPTION  
IN-PROCESS 7  
 CRIMP SHELL OVERBAND

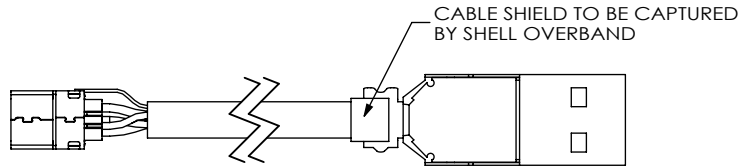

-MBS -AM END OPTION  
IN-PROCESS 8  
 ADD MINI USB B PREMOLD, SAME AS -MB IN-PROCESS 8

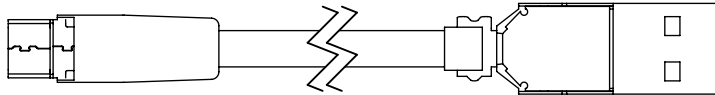

-MBS -AM END OPTION  
IN-PROCESS 9  
 ADD MINI USB B OVERMOLD, SAME AS -MB IN-PROCESS 9

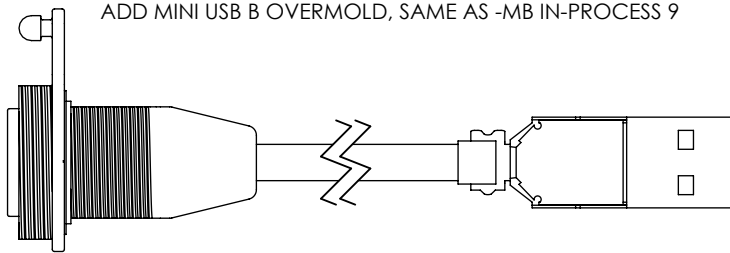

-MBS -AM END OPTION  
IN-PROCESS 10  
 ADD USB A OVERMOLD

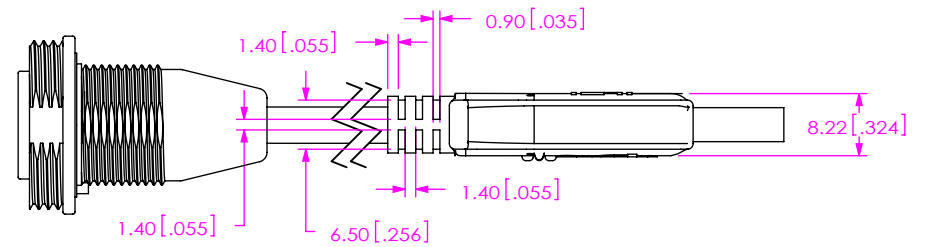
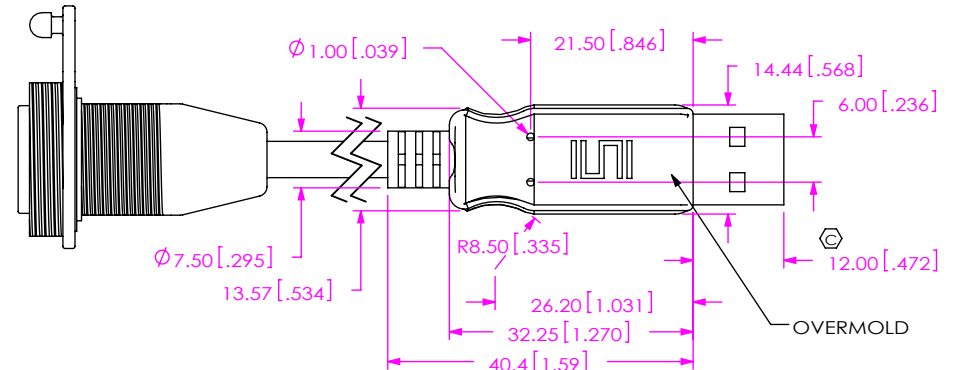

-MBS -AM END OPTION  
IN-PROCESS 11  
 ADD SPG-10-01 & SPN-10-01 & OR-10-01

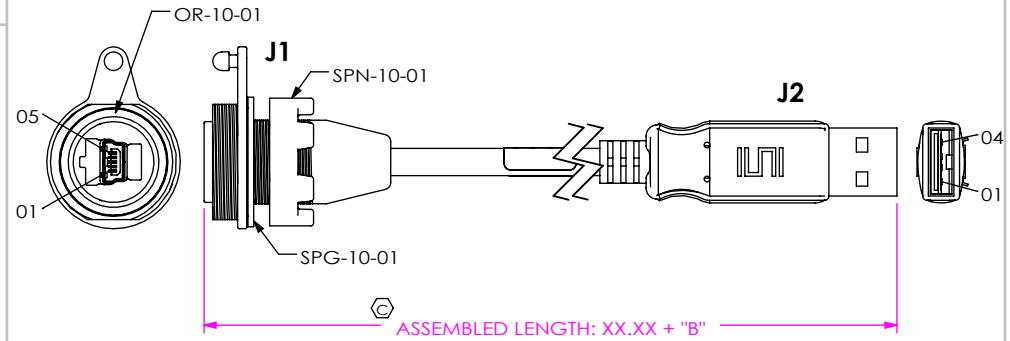

**PROPRIETARY NOTE**  
 THIS DOCUMENT CONTAINS CONFIDENTIAL AND PROPRIETARY INFORMATION AND ALL DESIGN, MANUFACTURING, REPRODUCTION, USE, PATENT RIGHTS AND SALES RIGHTS ARE EXPRESSLY RESERVED BY SAMTEC, INC. THIS DOCUMENT SHALL NOT BE DISCLOSED, IN WHOLE OR PART, TO ANY UNAUTHORIZED PERSON OR ENTITY NOR REPRODUCED, TRANSFERRED OR INCORPORATED IN ANY OTHER PROJECT IN ANY MANNER WITHOUT THE EXPRESS WRITTEN CONSENT OF SAMTEC, INC.

DO NOT SCALE DRAWING

SHEET SCALE: 1:5



520 PARK EAST BLVD, NEW ALBANY, IN 47150  
 PHONE: 812-944-6733 FAX: 812-948-5047  
 e-Mail: info@SAMTEC.com code: 55322

DESCRIPTION:  
 PANEL MOUNT SEALED MINI USB CABLE

DWG. NO.  
**SCRUS-10-X-XX.XX-XXX-XX**

BY: B. PERRY 09-01-2010 SHEET 8 OF 10

**-MBS -BM END OPTION  
IN-PROCESS 1  
STRIP OUTER JACKET TO DIMENSION SHOWN**

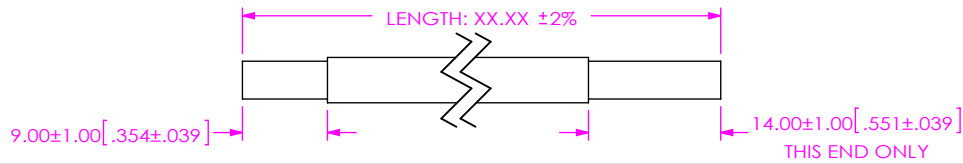

**-MBS -BM END OPTION  
IN-PROCESS 2  
TWIST SHIELD & TRIM INDIVIDUAL WIRES**

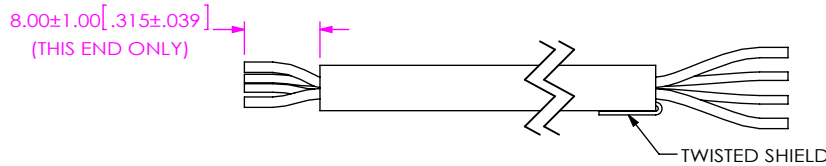

**-MBS -BM END OPTION  
IN-PROCESS 3  
STRIP INDIVIDUAL WIRES TO DIMENSION SHOWN**

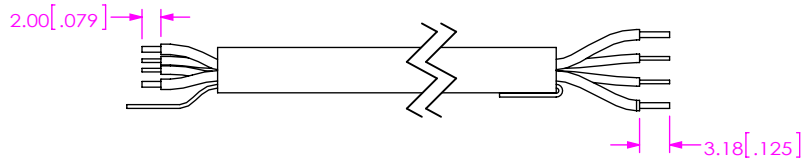

**-MBS -BM END OPTION  
IN-PROCESS 4  
TERMINATE TO MUSB-05-G-B-C & SUB-USB-B-G-B-01  
(SEE NOTE 19)**

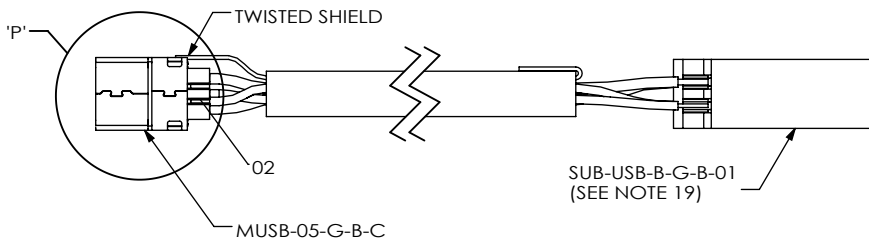
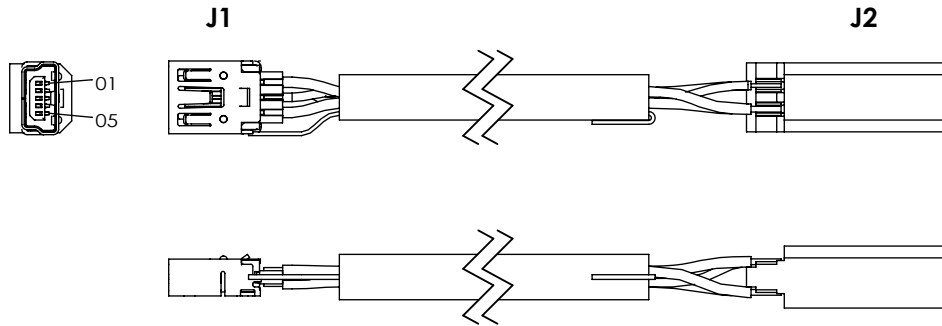

**-MBS -BM END OPTION  
IN-PROCESS 5  
ADD USB-B-N-01-01 SHELL (SEE NOTE 19)**

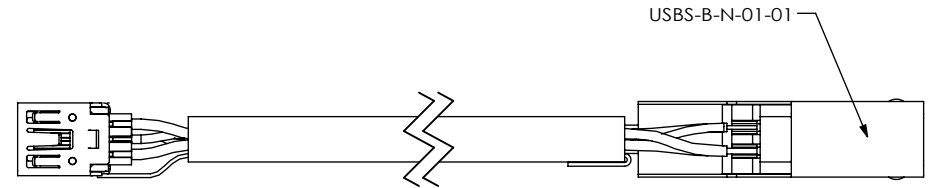

**-MBS -BM END OPTION  
IN-PROCESS 6  
ADD USB-B-N-02-01 SHELL (SEE NOTE 19)**

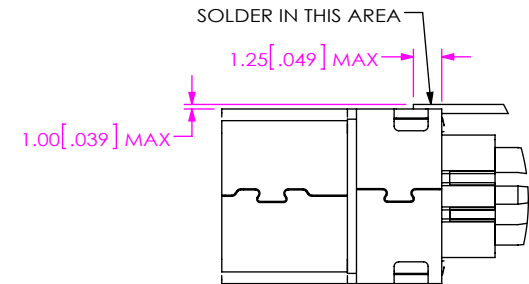
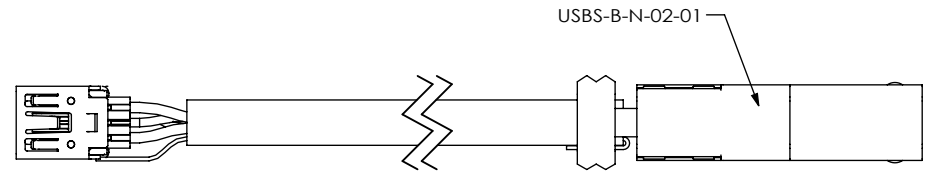

DETAIL 'P'  
SCALE 3 : 1

**PROPRIETARY NOTE**  
THIS DOCUMENT CONTAINS CONFIDENTIAL AND PROPRIETARY INFORMATION AND ALL DESIGN, MANUFACTURING, REPRODUCTION, USE, PATENT RIGHTS AND SALES RIGHTS ARE EXPRESSLY RESERVED BY SAMTEC, INC. THIS DOCUMENT SHALL NOT BE DISCLOSED, IN WHOLE OR PART, TO ANY UNAUTHORIZED PERSON OR ENTITY NOR REPRODUCED, TRANSFERRED OR INCORPORATED IN ANY OTHER PROJECT IN ANY MANNER WITHOUT THE EXPRESS WRITTEN CONSENT OF SAMTEC, INC.

DO NOT SCALE DRAWING

SHEET SCALE: 1:5



520 PARK EAST BLVD, NEW ALBANY, IN 47150  
PHONE: 812-944-6733 FAX: 812-948-5047  
e-Mail: info@SAMTEC.com code: 55322

DESCRIPTION:  
PANEL MOUNT SEALED MINI USB CABLE

DWG. NO.  
SCRUS-10-X-XX.XX-XXX-XX

BY: B. PERRY 09-01-2010 SHEET 9 OF 10

-MBS -BM END OPTION  
IN-PROCESS 7  
CRIMP SHELL OVERBAND

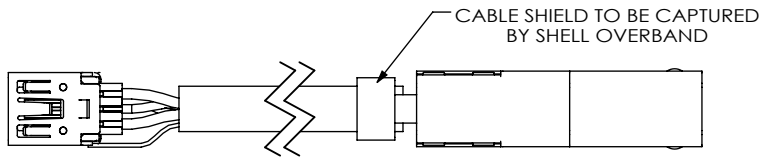

-MBS -BM END OPTION  
IN-PROCESS 8  
ADD MINI USB B PREMOLD, SAME AS -MB IN-PROCESS 8

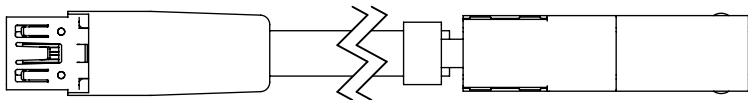

-MBS -BM END OPTION  
IN-PROCESS 9  
ADD MINI USB B OVERMOLD, SAME AS -MB IN-PROCESS 9

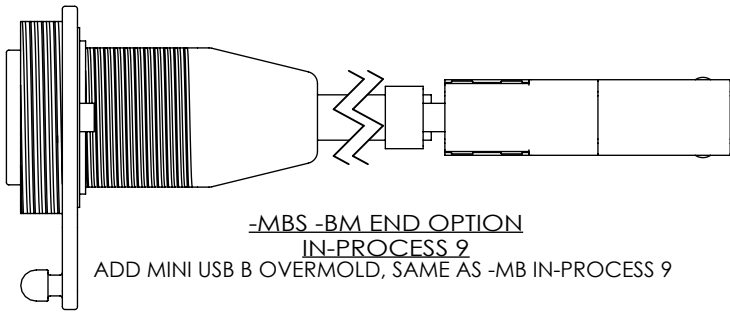

-MBS -BM END OPTION  
IN-PROCESS 10  
ADD USB B OVERMOLD

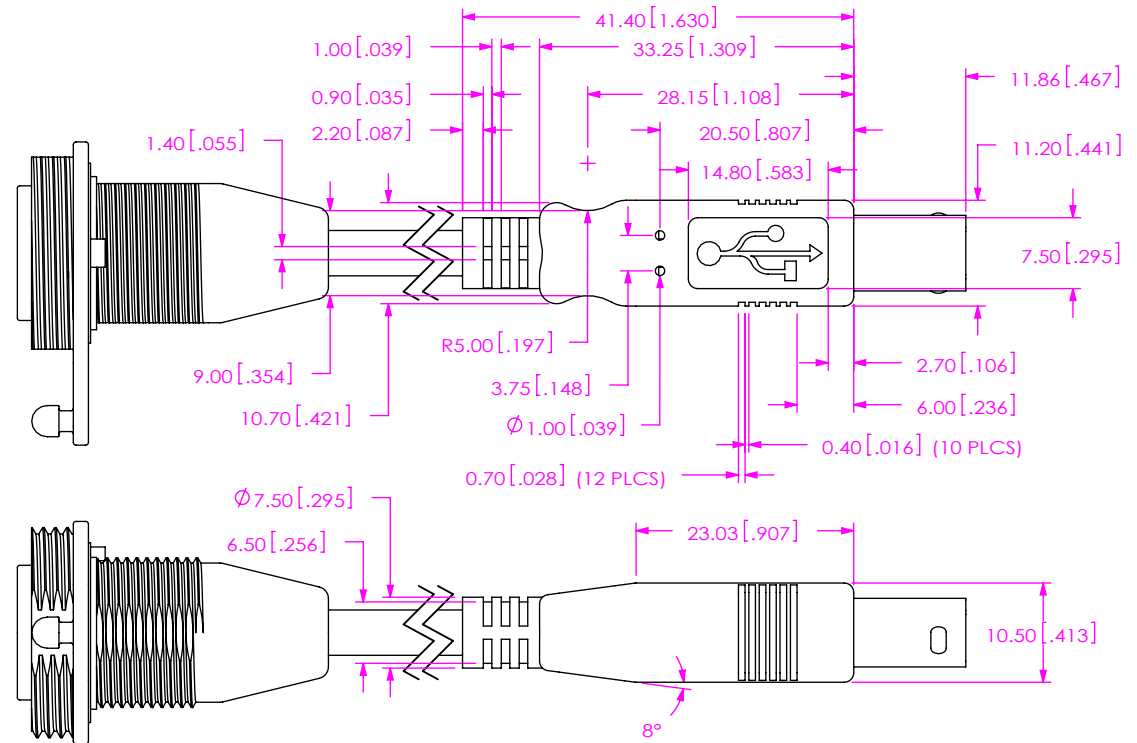

-MBS -BM END OPTION  
IN-PROCESS 11  
ADD SPG-10-01 & SPN-10-01 & OR-10-01

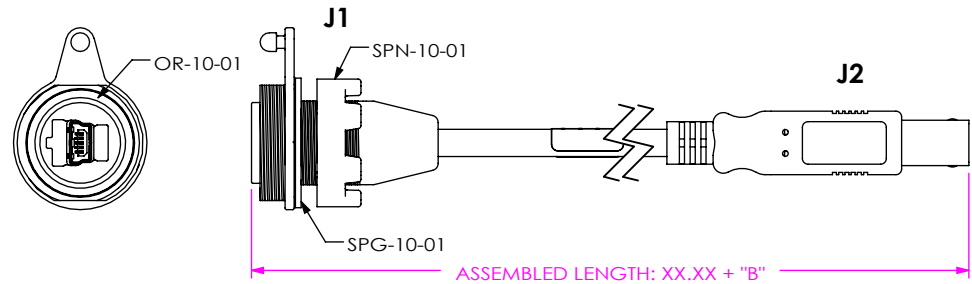

**PROPRIETARY NOTE**  
THIS DOCUMENT CONTAINS CONFIDENTIAL AND PROPRIETARY INFORMATION AND ALL DESIGN, MANUFACTURING, REPRODUCTION, USE, PATENT RIGHTS AND SALES RIGHTS ARE EXPRESSLY RESERVED BY SAMTEC, INC. THIS DOCUMENT SHALL NOT BE DISCLOSED, IN WHOLE OR PART, TO ANY UNAUTHORIZED PERSON OR ENTITY NOR REPRODUCED, TRANSFERRED OR INCORPORATED IN ANY OTHER PROJECT IN ANY MANNER WITHOUT THE EXPRESS WRITTEN CONSENT OF SAMTEC, INC.

DO NOT SCALE DRAWING  
SHEET SCALE: 1:5



520 PARK EAST BLVD, NEW ALBANY, IN 47150  
PHONE: 812-944-6733 FAX: 812-948-5047  
e-Mail: info@SAMTEC.com code: 55322

DESCRIPTION:  
PANEL MOUNT SEALED MINI USB CABLE  
DWG. NO.  
**SCRUS-10-X-XX.XX-XXX-XX**  
BY: B. PERRY 09-01-2010 SHEET 10 OF 10