



Chipsmall Limited consists of a professional team with an average of over 10 year of expertise in the distribution of electronic components. Based in Hongkong, we have already established firm and mutual-benefit business relationships with customers from,Europe,America and south Asia,supplying obsolete and hard-to-find components to meet their specific needs.

With the principle of “Quality Parts,Customers Priority,Honest Operation,and Considerate Service”,our business mainly focus on the distribution of electronic components. Line cards we deal with include Microchip,ALPS,ROHM,Xilinx,Pulse,ON,Everlight and Freescale. Main products comprise IC,Modules,Potentiometer,IC Socket,Relay,Connector.Our parts cover such applications as commercial,industrial, and automotives areas.

We are looking forward to setting up business relationship with you and hope to provide you with the best service and solution. Let us make a better world for our industry!



Contact us

Tel: +86-755-8981 8866 Fax: +86-755-8427 6832

Email & Skype: info@chipsmall.com Web: www.chipsmall.com

Address: A1208, Overseas Decoration Building, #122 Zhenhua RD., Futian, Shenzhen, China



Small Signal Schottky Diodes

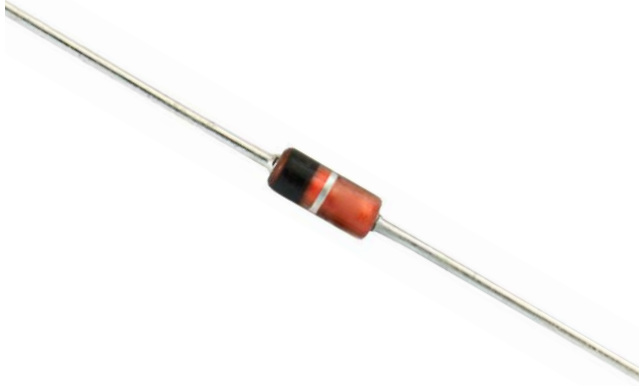

MECHANICAL DATA

Case: DO-35

Weight: approx. 125 mg

Cathode band color: black

Packaging codes/options:

TR/10K per 13" reel (52 mm tape), 50K/box

TAP/10K per ammpack (52 mm tape), 50K/box

FEATURES

- The SD103 series is a metal-on-silicon Schottky barrier device which is protected by a PN junction guarding
- The low forward voltage drop and fast switching make it ideal for protection of MOS devices, steering, biasing and coupling diodes for fast switching and low logic level applications
- Other applications are click suppression, efficient full wave bridges in telephone subsets, and blocking diodes in rechargeable low voltage battery systems
- These diodes are also available in the SOD-123 and SOD-323 case with type designations SD103AW(S) to SD103CW(S), and in the MiniMELF case with type designations LL103A thru LL103C
- For general purpose applications
- AEC-Q101 qualified
- Material categorization: for definitions of compliance please see www.vishay.com/doc?99912



RoHS
COMPLIANT
HALOGEN
FREE

APPLICATIONS

- HF-detector
- Protection circuit
- Small battery charger
- AC/DC, DC/DC converters

PARTS TABLE

PART	TYPE DIFFERENTIATION	ORDERING CODE	TYPE MARKING	INTERNAL CONSTRUCTION	REMARKS
SD103A	$V_R = 40\text{ V}$	SD103A-TR or SD103A-TAP	SD103A	Single diode	Tape and reel/ammpack
SD103B	$V_R = 30\text{ V}$	SD103B-TR or SD103B-TAP	SD103B	Single diode	Tape and reel/ammpack
SD103C	$V_R = 20\text{ V}$	SD103C-TR or SD103C-TAP	SD103C	Single diode	Tape and reel/ammpack

ABSOLUTE MAXIMUM RATINGS ($T_{amb} = 25\text{ }^\circ\text{C}$, unless otherwise specified)

PARAMETER	TEST CONDITION	PART	SYMBOL	VALUE	UNIT
Peak inverse voltage		SD103A	V_R	40	V
		SD103B	V_R	30	V
		SD103C	V_R	20	V
Power dissipation (infinite heat sink) ⁽¹⁾			P_{tot}	400	mW
Peak forward surge current	$t_p = 300\text{ }\mu\text{s}$ square pulse		I_{FSM}	15	A

Note

⁽¹⁾ Valid provided that leads at a distance of 4 mm from case are kept at ambient temperature

THERMAL CHARACTERISTICS ($T_{amb} = 25\text{ }^\circ\text{C}$, unless otherwise specified)

PARAMETER	TEST CONDITION	SYMBOL	VALUE	UNIT
Thermal resistance junction to ambient air ⁽¹⁾		R_{thJA}	310	K/W
Junction temperature		T_j	125	$^\circ\text{C}$
Storage temperature range		T_{stg}	-55 to +150	$^\circ\text{C}$

Note

⁽¹⁾ Valid provided that leads at a distance of 4 mm from case are kept at ambient temperature



ELECTRICAL CHARACTERISTICS (T _{amb} = 25 °C, unless otherwise specified)							
PARAMETER	TEST CONDITION	PART	SYMBOL	MIN.	TYP.	MAX.	UNIT
Reverse breakdown voltage	I _R = 50 μA	SD103A	V _(BR)	40			V
		SD103B	V _(BR)	30			V
		SD103C	V _(BR)	20			V
Leakage current	V _R = 30 V	SD103A	I _R			5	μA
	V _R = 20 V	SD103B	I _R			5	μA
	V _R = 10 V	SD103C	I _R			5	μA
Forward voltage drop	I _F = 20 mA		V _F			370	mV
	I _F = 200 mA		V _F			600	mV
Diode capacitance	V _R = 0 V, f = 1 MHz		C _D		50		pF
Reverse recovery time	I _F = I _R = 50 mA to 200 mA, recover to 0.1 I _R		t _{rr}		10		ns

TYPICAL CHARACTERISTICS (T_{amb} = 25 °C, unless otherwise specified)

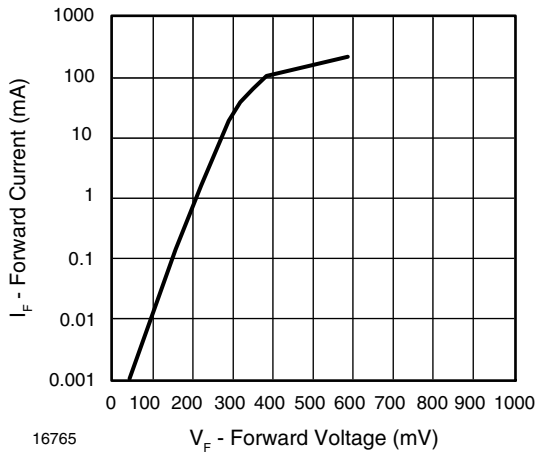

Fig. 1 - Forward Current vs. Forward Voltage

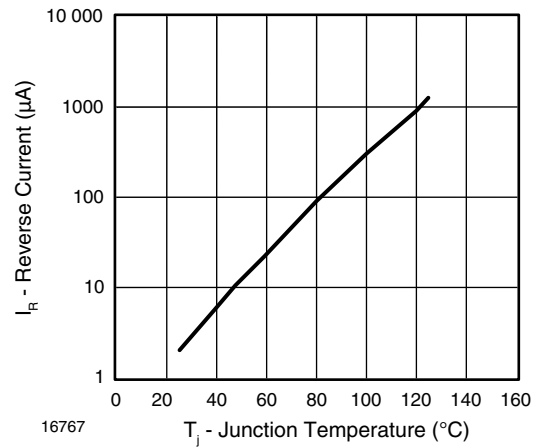

Fig. 3 - Reverse Current vs. Junction Temperature

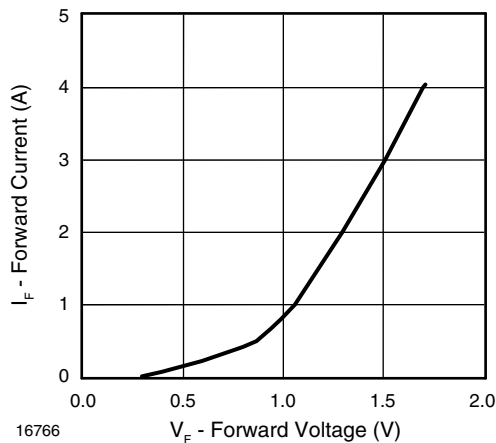

Fig. 2 - Forward Current vs. Forward Voltage

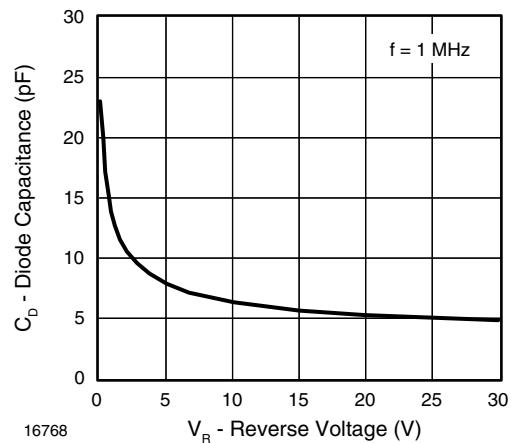

Fig. 4 - Diode Capacitance vs. Reverse Voltage

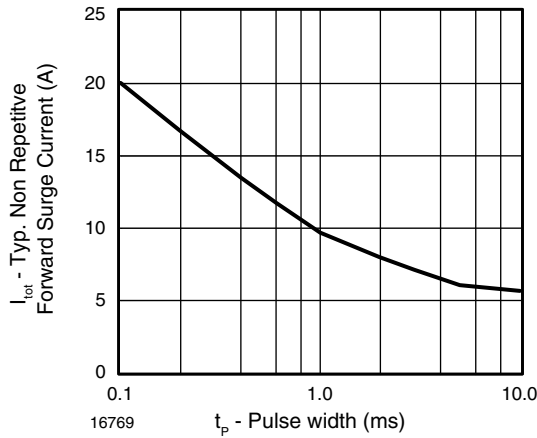
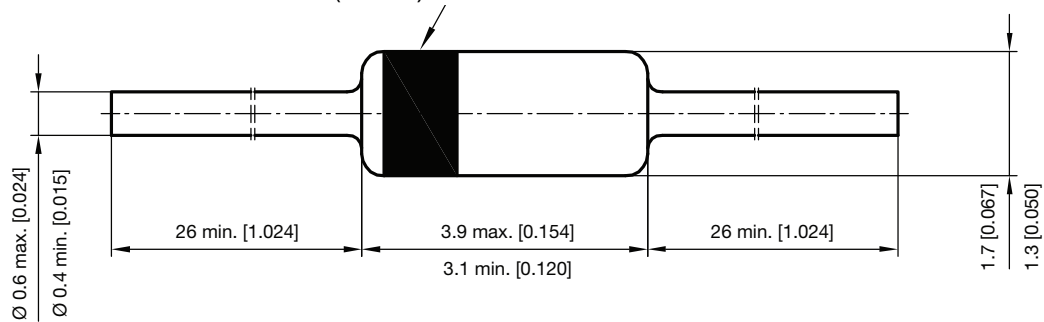

Fig. 5 - Typical Non-Repetitive Forward Surge Current vs. Pulse Width

PACKAGE DIMENSIONS in millimeters (inches): **DO-35**



Rev. 6 - Date: 19. December 2011
 Document no.: SB-V-3906.04-031(4)
 94 9366



Disclaimer

ALL PRODUCT, PRODUCT SPECIFICATIONS AND DATA ARE SUBJECT TO CHANGE WITHOUT NOTICE TO IMPROVE RELIABILITY, FUNCTION OR DESIGN OR OTHERWISE.

Vishay Intertechnology, Inc., its affiliates, agents, and employees, and all persons acting on its or their behalf (collectively, "Vishay"), disclaim any and all liability for any errors, inaccuracies or incompleteness contained in any datasheet or in any other disclosure relating to any product.

Vishay makes no warranty, representation or guarantee regarding the suitability of the products for any particular purpose or the continuing production of any product. To the maximum extent permitted by applicable law, Vishay disclaims (i) any and all liability arising out of the application or use of any product, (ii) any and all liability, including without limitation special, consequential or incidental damages, and (iii) any and all implied warranties, including warranties of fitness for particular purpose, non-infringement and merchantability.

Statements regarding the suitability of products for certain types of applications are based on Vishay's knowledge of typical requirements that are often placed on Vishay products in generic applications. Such statements are not binding statements about the suitability of products for a particular application. It is the customer's responsibility to validate that a particular product with the properties described in the product specification is suitable for use in a particular application. Parameters provided in datasheets and / or specifications may vary in different applications and performance may vary over time. All operating parameters, including typical parameters, must be validated for each customer application by the customer's technical experts. Product specifications do not expand or otherwise modify Vishay's terms and conditions of purchase, including but not limited to the warranty expressed therein.

Except as expressly indicated in writing, Vishay products are not designed for use in medical, life-saving, or life-sustaining applications or for any other application in which the failure of the Vishay product could result in personal injury or death. Customers using or selling Vishay products not expressly indicated for use in such applications do so at their own risk. Please contact authorized Vishay personnel to obtain written terms and conditions regarding products designed for such applications.

No license, express or implied, by estoppel or otherwise, to any intellectual property rights is granted by this document or by any conduct of Vishay. Product names and markings noted herein may be trademarks of their respective owners.