



Chipsmall Limited consists of a professional team with an average of over 10 year of expertise in the distribution of electronic components. Based in Hongkong, we have already established firm and mutual-benefit business relationships with customers from,Europe,America and south Asia,supplying obsolete and hard-to-find components to meet their specific needs.

With the principle of “Quality Parts,Customers Priority,Honest Operation,and Considerate Service”,our business mainly focus on the distribution of electronic components. Line cards we deal with include Microchip,ALPS,ROHM,Xilinx,Pulse,ON,Everlight and Freescale. Main products comprise IC,Modules,Potentiometer,IC Socket,Relay,Connector.Our parts cover such applications as commercial,industrial, and automotives areas.

We are looking forward to setting up business relationship with you and hope to provide you with the best service and solution. Let us make a better world for our industry!



Contact us

Tel: +86-755-8981 8866 Fax: +86-755-8427 6832

Email & Skype: info@chipsmall.com Web: www.chipsmall.com

Address: A1208, Overseas Decoration Building, #122 Zhenhua RD., Futian, Shenzhen, China



HF/VHF/UHF RF power N-channel MOSFET

Datasheet - production data

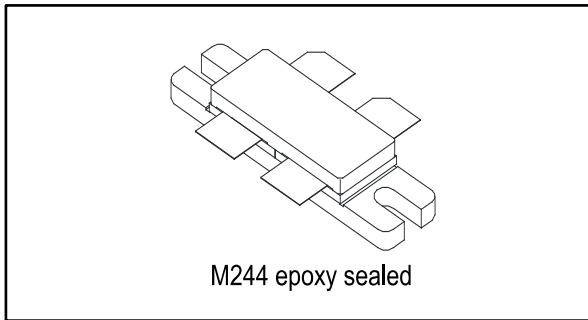
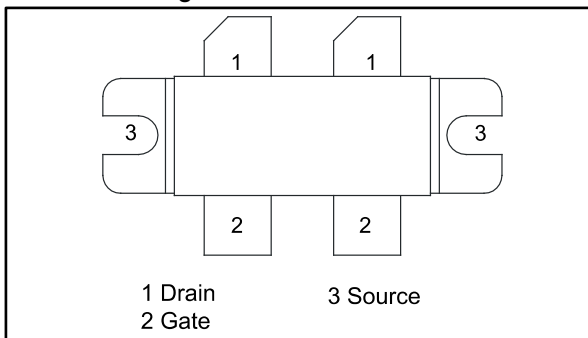

Figure 1: Pin connection



Features

- Gold metallization
- Excellent thermal stability
- Common source push-pull configuration
- $P_{OUT} = 300\text{ W min. with } 15\text{ dB gain @ } 175\text{ MHz}$

Description

The SD2932 is a gold metallized N-channel MOS field-effect RF power transistor used for 50 V DC large signal applications up to 250 MHz.

Table 1: Device summary

Order code	Marking	Package	Packing
SD2932W	SD2932 ⁽¹⁾	M244	Tube

Notes:

⁽¹⁾For more details please refer to [Section 11: "Marking, packing and shipping specifications"](#).

Contents

1 Electrical data 3

 1.1 Maximum ratings 3

 1.2 Thermal data 3

2 Electrical characteristics 4

3 Impedance data 5

4 Typical performance 6

 4.1 Typical performance (175 MHz) 8

5 Test circuit (175 MHz) 9

6 Test circuit photomaster 11

7 Typical broadband data (175-230 MHz) 12

8 Test circuit 175 - 230 MHz 13

9 Typical broadband data (88 - 108 MHz) 14

10 Test circuit 88-108 MHz 15

11 Marking, packing and shipping specifications 16

12 Package information 17

 12.1 M244 package information 17

13 Revision history 19



1 Electrical data

1.1 Maximum ratings

$T_{CASE} = 25\text{ °C}$

Table 2: Absolute maximum ratings

Symbol	Parameter	Value	Unit
$V_{(BR)DSS}$	Drain source voltage	125	V
V_{DGR}	Drain-gate voltage ($R_{GS} = 1\text{ M}\Omega$)	125	V
V_{GS}	Gate-source voltage	± 40	V
I_D	Drain current	40	A
P_{DISS}	Power dissipation	500	W
T_J	Max. operating junction temperature	+200	°C
T_{STG}	Storage temperature	-65 to +150	°C

1.2 Thermal data

Table 3: Thermal data

Symbol	Parameter	Value	Unit
R_{thJC}	Junction-to-case thermal resistance	0.35	°C/W

2 Electrical characteristics

$T_{CASE} = 25\text{ °C}$

Table 4: Static

Symbol	Test conditions		Min.	Typ.	Max.	Unit
$V_{(BR)DSS}$	$V_{GS} = 0\text{ V}$	$I_{DS} = 100\text{ mA}$	125			V
I_{DSS}	$V_{GS} = 0\text{ V}$	$V_{DS} = 50\text{ V}$			50	μA
I_{GSS}	$V_{GS} = 20\text{ V}$	$V_{DS} = 0\text{ V}$			250	nA
$V_{GS(Q)}$	$V_{DS} = 10\text{ V}$	$I_D = 250\text{ mA}$	1.5		4	V
$V_{DS(ON)}$	$V_{GS} = 10\text{ V}$	$I_D = 10\text{ A}$			3.0	V
G_{FS}	$V_{DS} = 10\text{ V}$	$I_D = 5\text{ A}$	5			mho
$\Delta V_{GS}^{(1)}$	$V_{DS} = 10\text{ V}$	$I_D = 250\text{ mA}$			200	mV
C_{ISS}	$V_{GS} = 0\text{ V}$	$V_{DS} = 50\text{ V}$		480		pF
C_{OSS}	$V_{GS} = 0\text{ V}$	$V_{DS} = 50\text{ V}$		190		pF
C_{RSS}	$V_{GS} = 0\text{ V}$	$V_{DS} = 50\text{ V}$		18		pF

Notes:

⁽¹⁾Absolute V_{GS} difference between side 1 and side 2 of the device.

Table 5: Dynamic

Symbol	Test conditions		Min.	Typ.	Max.	Unit
P_{OUT}	$V_{DD} = 50\text{ V}$	$I_{DQ} = 500\text{ mA}$ $f = 175\text{ MHz}$	300			W
G_{PS}	$V_{DD} = 50\text{ V}$	$I_{DQ} = 500\text{ mA}$ $P_{OUT} = 300\text{ W}$ $f = 175\text{ MHz}$	15	16		dB
η_D	$V_{DD} = 50\text{ V}$	$I_{DQ} = 500\text{ mA}$ $P_{OUT} = 300\text{ W}$ $f = 175\text{ MHz}$	50	60		%
Load mismatch	$V_{DD} = 50\text{ V}$	$I_{DQ} = 500\text{ mA}$ $P_{OUT} = 300\text{ W}$ $f = 175\text{ MHz}$ All phase angles	5:1			VSWR

3 Impedance data

Figure 2: Impedance data

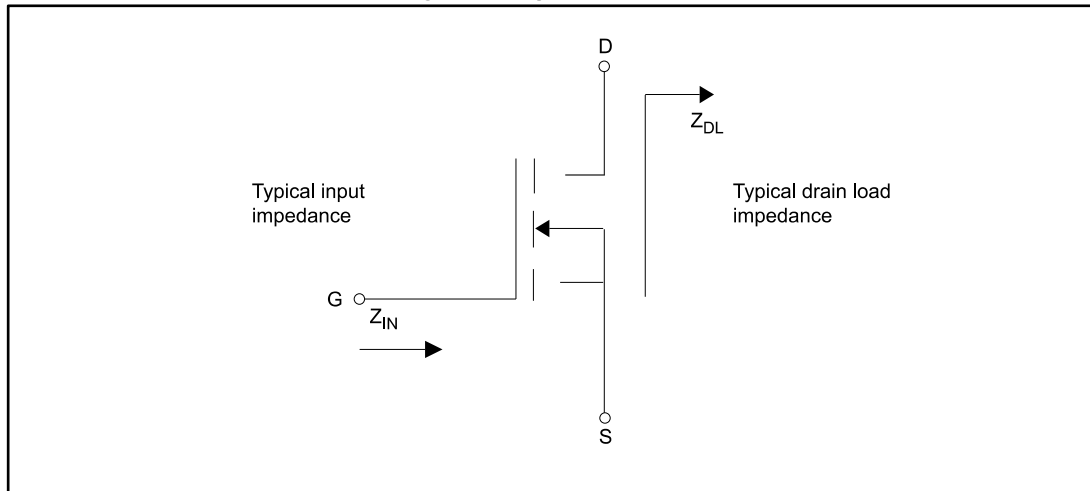

Table 6: Impedance data

f	$Z_{IN}(\Omega)$	$Z_{DL}(\Omega)$
175 MHz	$0.92 - j 0.14$	$3.17 + j 4.34$



Measured gate-to-gate and drain-to-drain, respectively.

4 Typical performance

Figure 3: Maximum thermal resistance vs. case temperature

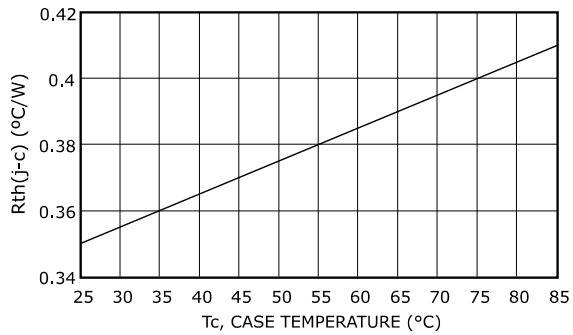

Figure 4: Gate voltage vs. case temperature

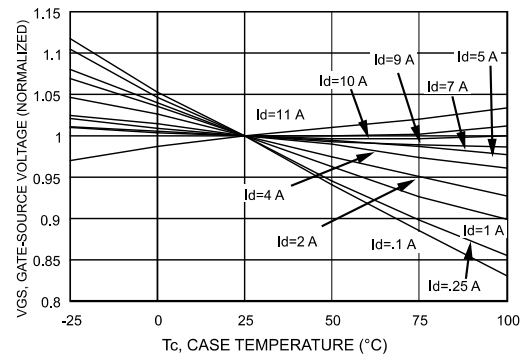

Figure 5: Capacitance vs. drain-source voltage

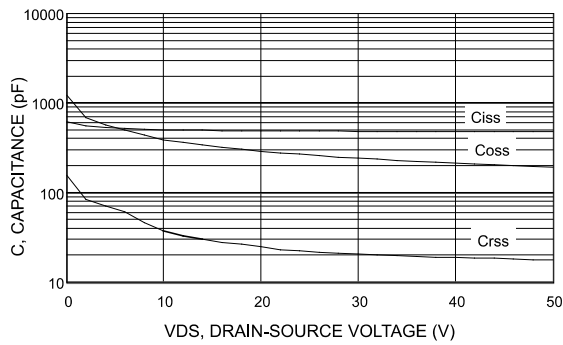

Figure 6: Drain current vs. gate voltage

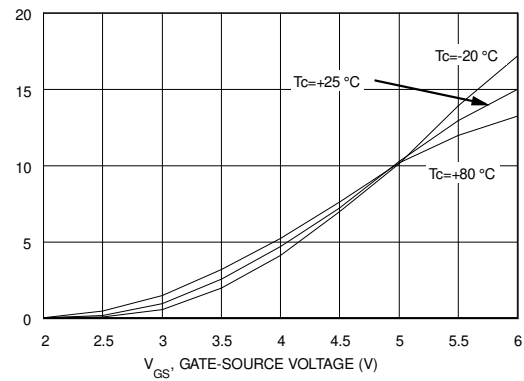

Figure 7: Maximum safe operating area

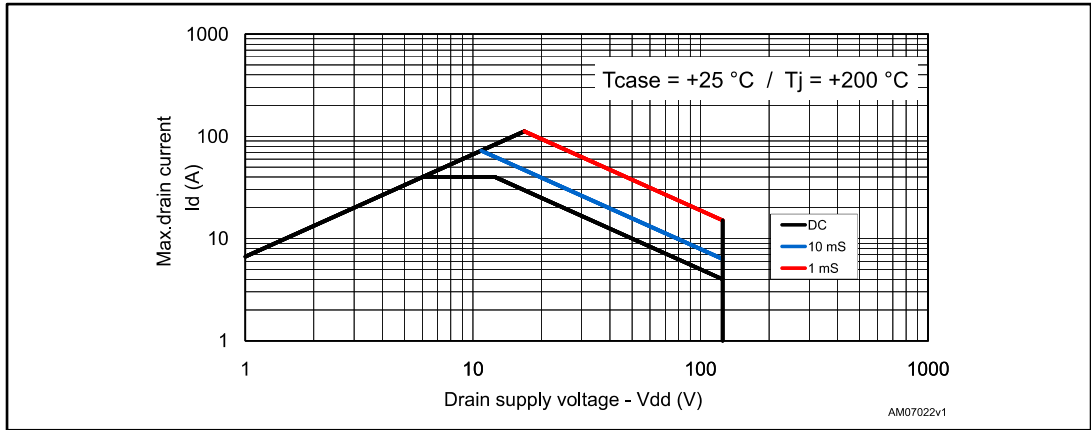

Figure 8: Transient thermal impedance

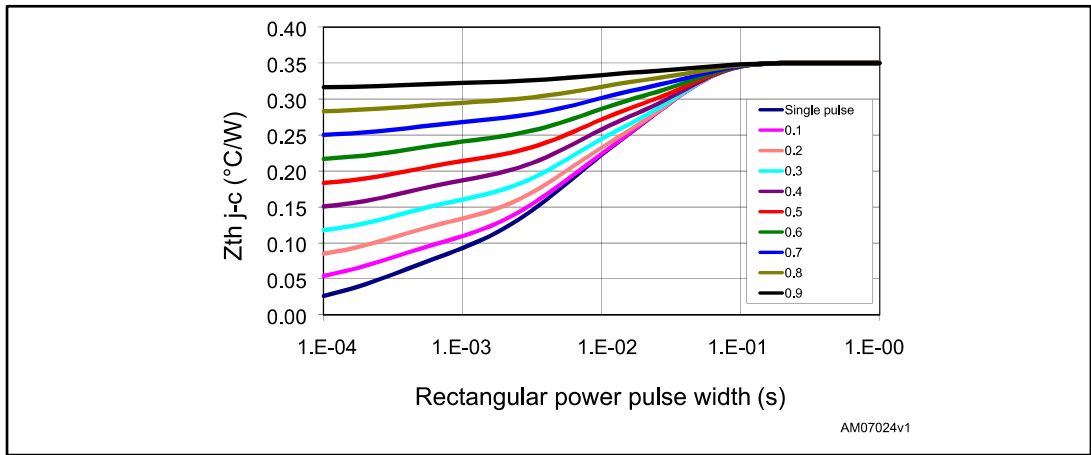
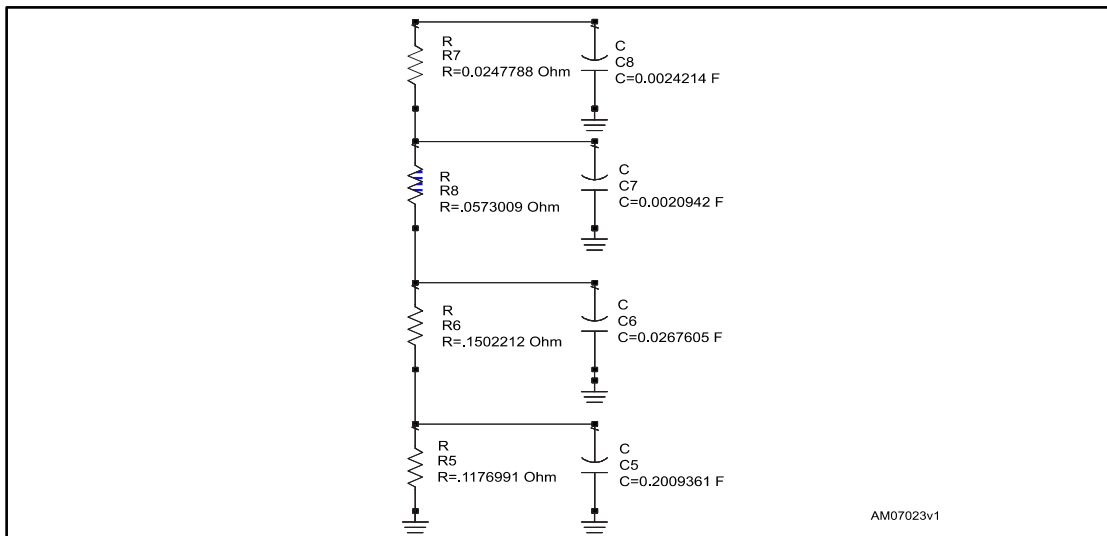
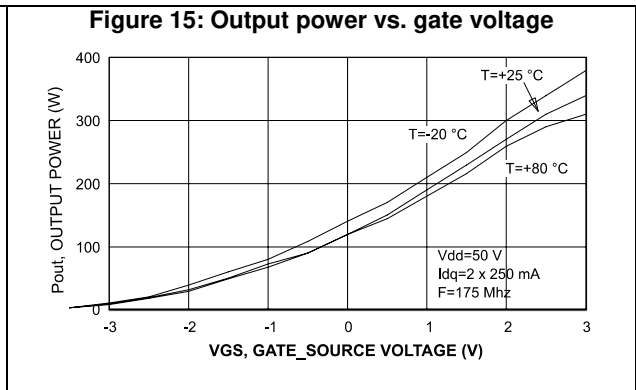
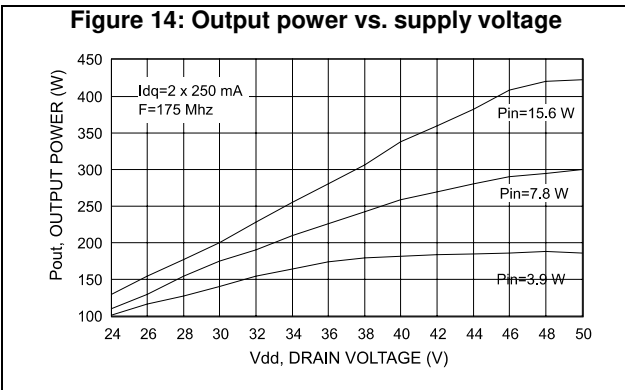
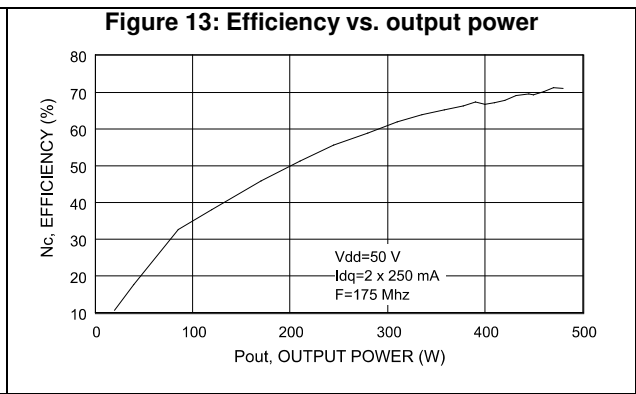
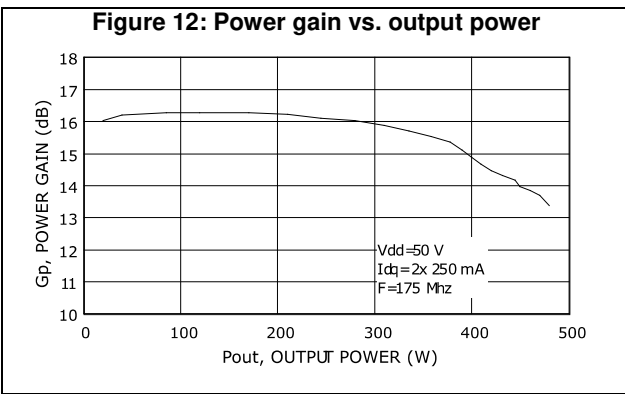
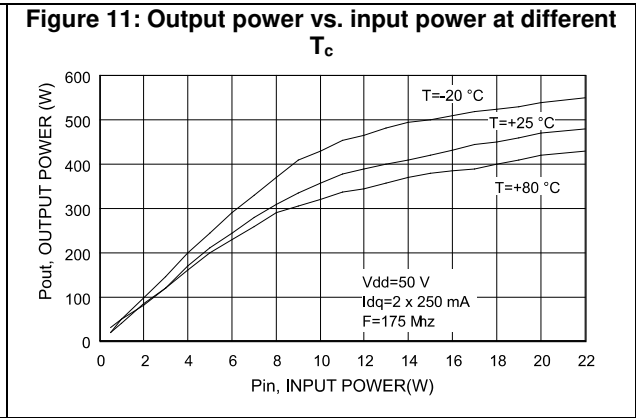
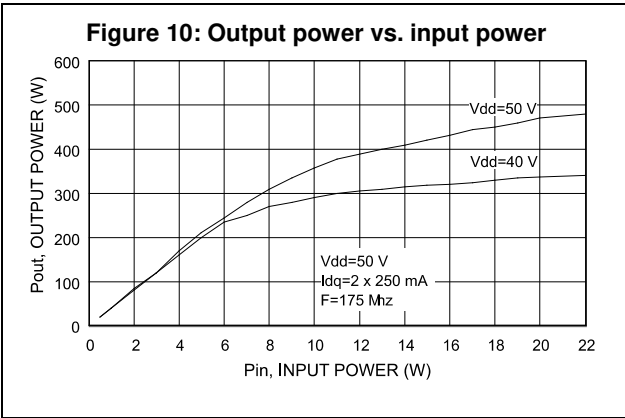

Figure 9: Transient thermal model



4.1 Typical performance (175 MHz)



5 Test circuit (175 MHz)

Figure 16: 175 MHz production test circuit schematic

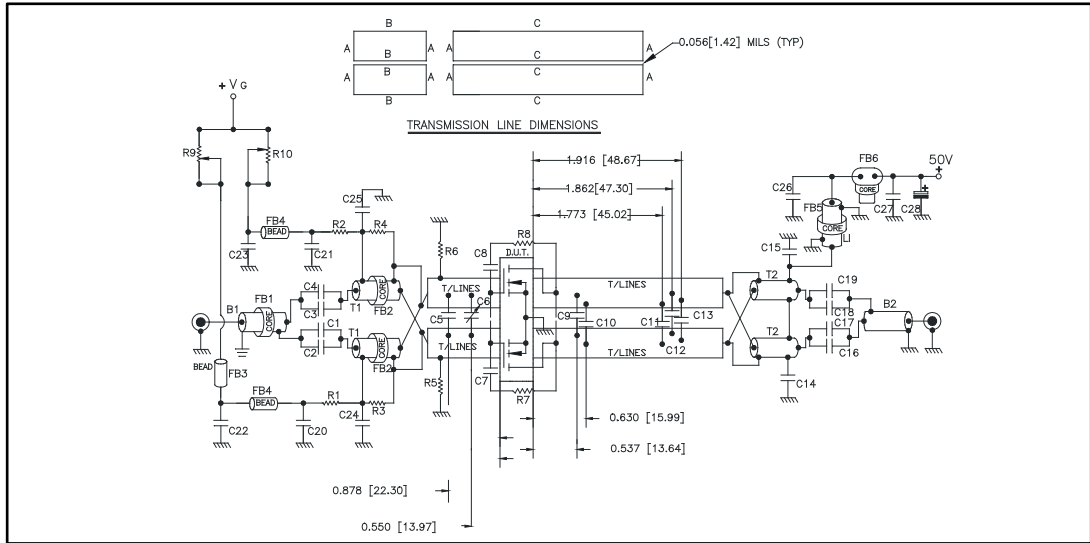

Table 7: 175 MHz test circuit part list

Component	Description
R1, R2, R5, R6	470 Ohm 1 W, surface mount chip resistor
R3, R4	360 Ohm 0.5 W, carbon comp. axial lead resistor or equivalent
R7, R8	560 Ohm 2 W, resistor 2 turn wire air-wound axial lead resistor
R9, R10	20 kOhm 3.09 W, 10 turn wirewound precision potentiometer
C1, C4	680 pF ATC 130B surface mount ceramic chip capacitor
C2, C3, C7, C8, C17, C19, C20, C21	10000 pF ATC 200B surface mount ceramic chip capacitor
C5	75 pF ATC 100B surface mount ceramic chip capacitor
C6	ST40 25 pF - 115 pF miniature variable trimmer
C9, C10	47 pF ATC 100B surface mount ceramic chip capacitor
C11, C12, C13	43 pF ATC 100B surface mount ceramic chip capacitor
C14, C15, C24, C25	1200 pF ATC 700B surface mount ceramic chip capacitor
C16, C18	470 pF ATC 700B surface mount ceramic chip capacitor
C22, C23	0.1 μF / 500 V surface mount ceramic chip capacitor
C26, C27	0.01 μF / 500 V surface mount ceramic chip capacitor
C28	10 μF / 63 aluminum electrolytic axial lead capacitor
B1	50 Ohm RG316 O.D 0.076[1.93] L = 11.80[299.72] flexible coaxial cable 4 turns through ferrite bead
B2	50 Ohm RG-142B O.D 0.165[4.19] L = 11.80[299.72] flexible coaxial cable

Component	Description
T1	R.F. transformer 4:1, 25 Ohm O.D RG316-25 O.D 0.080[2.03] L = 5.90[149.86] flexible coaxial cable 2 turns through ferrite multi-aperture core
T2	R.F. transformer 1:4, 25 Ohm semi-rigid coaxial cable O.D. 0.141[3.58] L = 5.90[149.86]
L1	Inductor λ 1/4 wave 50 Ohm O.D 0.165[4.19] L = 11.80 [299.72] flexible coaxial cable 2 turns through ferrite bead
FB1, FB5	Shield bead
FB2, FB6	Multi-aperture core
FB3	Multilayer ferrite chip bead (surface mount)
FB4	Surface mount EMI shield bead
PCB	Woven glass reinforced PTFE microwave laminate 0.06", 1 oz EDCu, both sides, $\epsilon_r = 2.55$

6 Test circuit photomaster

Figure 17: 175 MHz test circuit photomaster

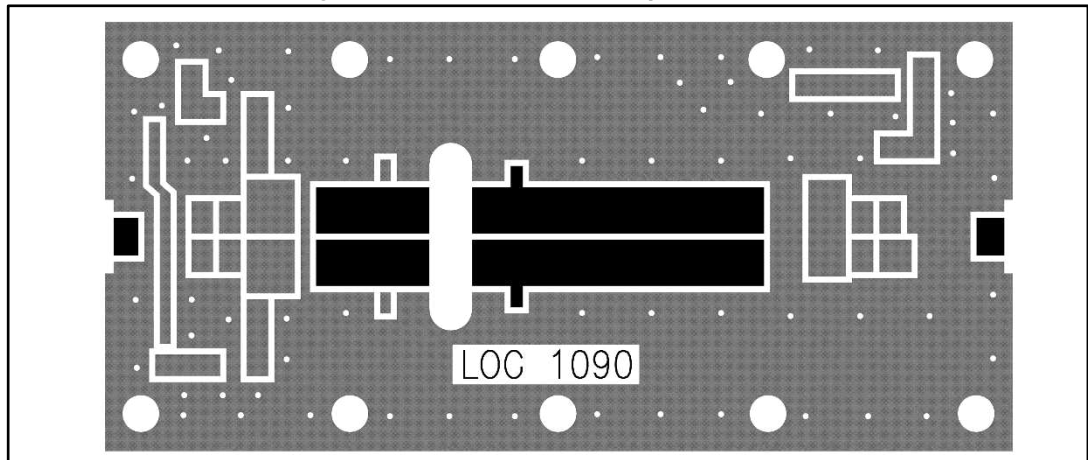
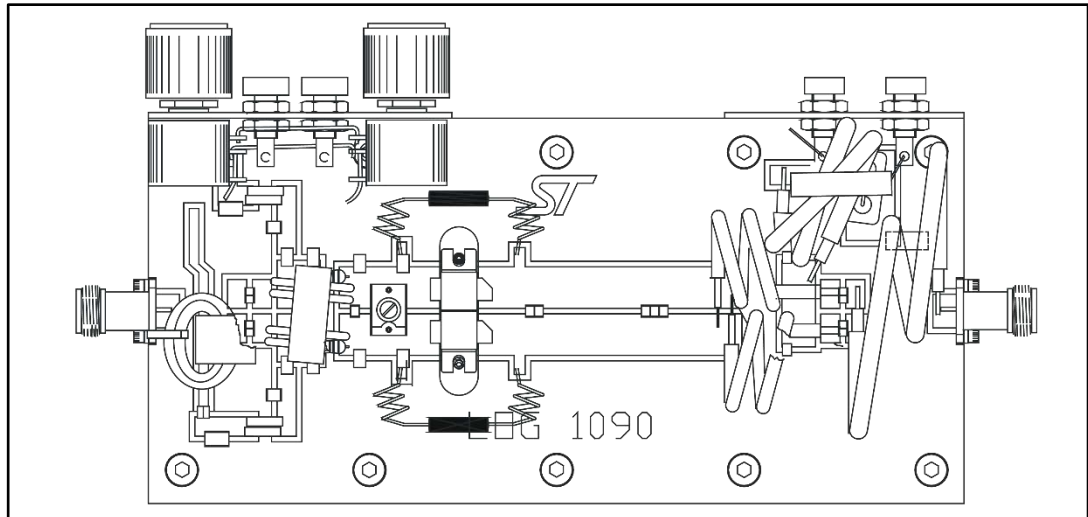
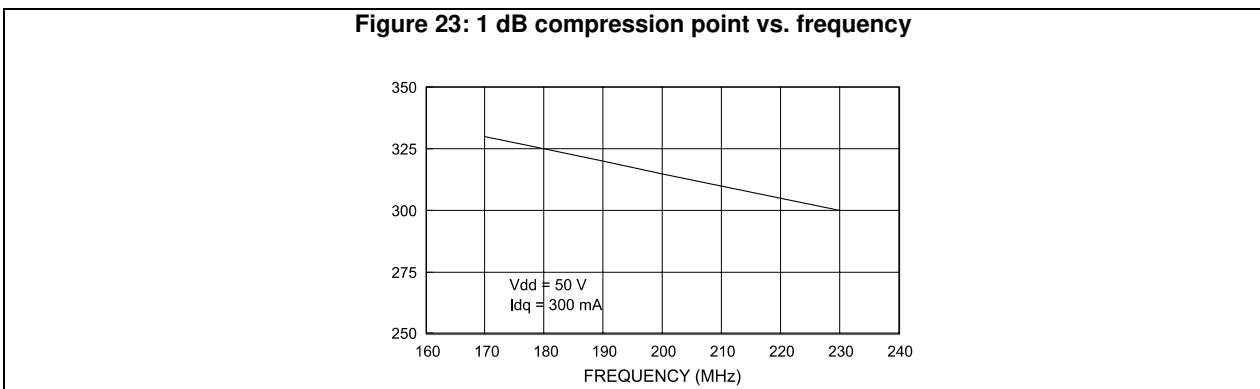
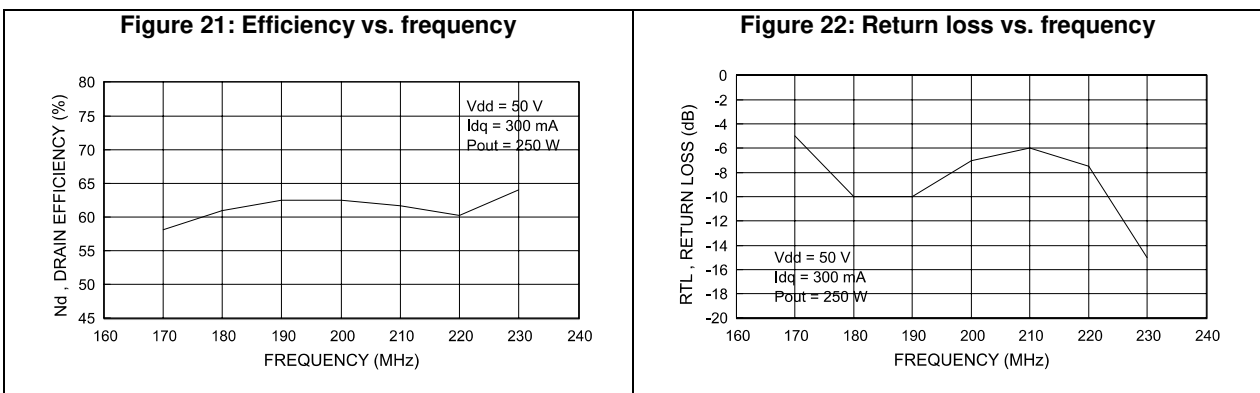
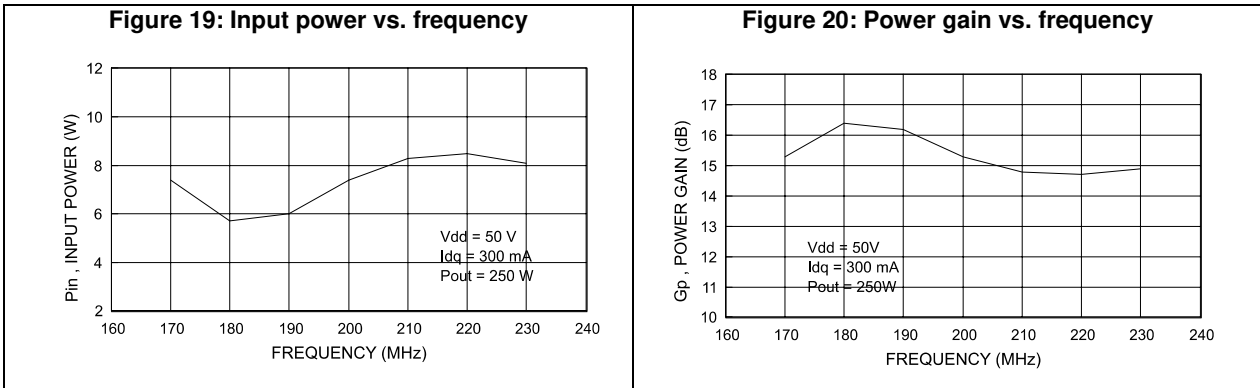

Figure 18: 175 MHz test fixture



7 Typical broadband data (175-230 MHz)



8 Test circuit 175 - 230 MHz

Figure 24: 175 - 230 MHz test circuit layout (engineering fixture)

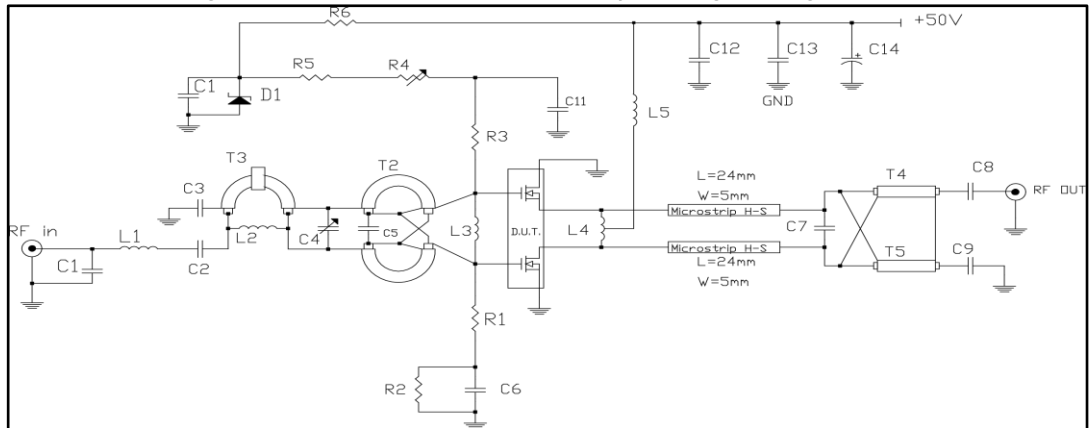
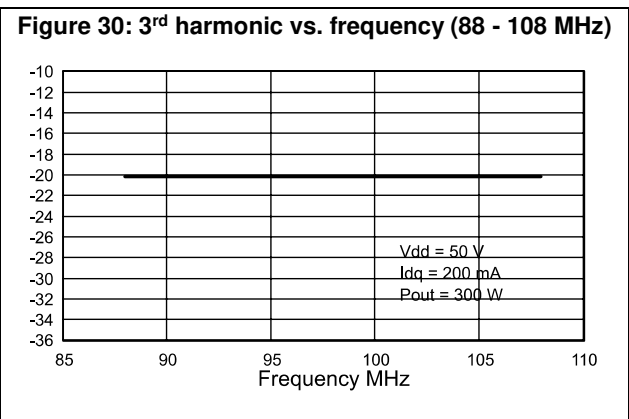
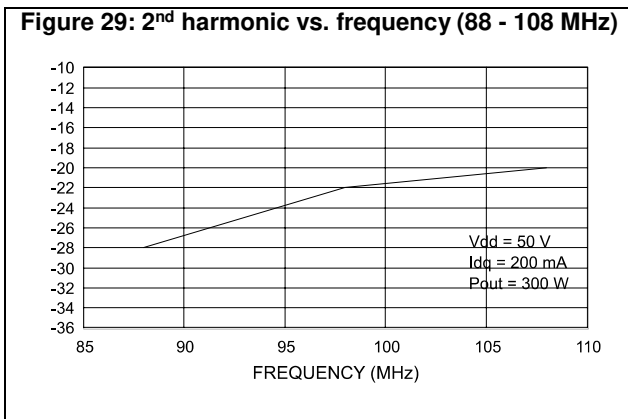
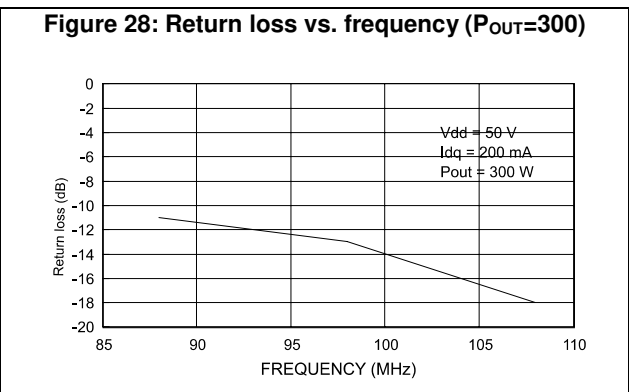
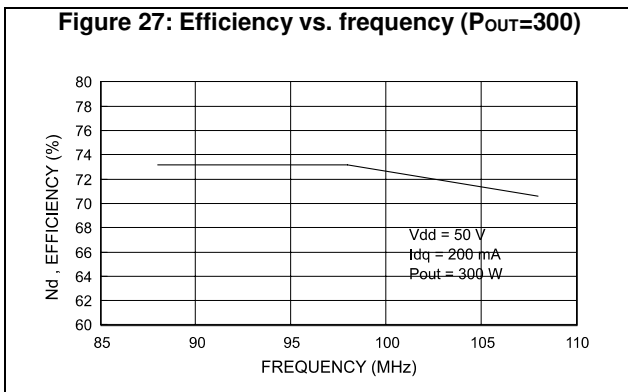
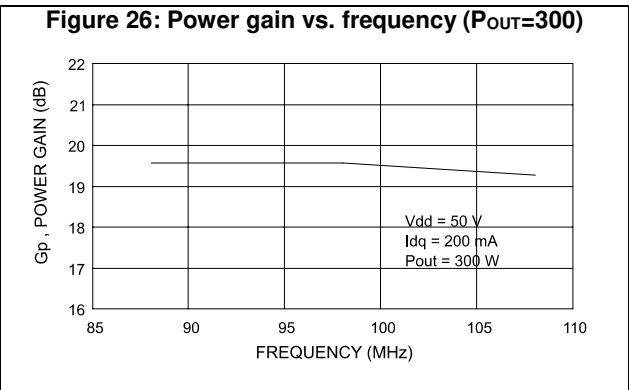
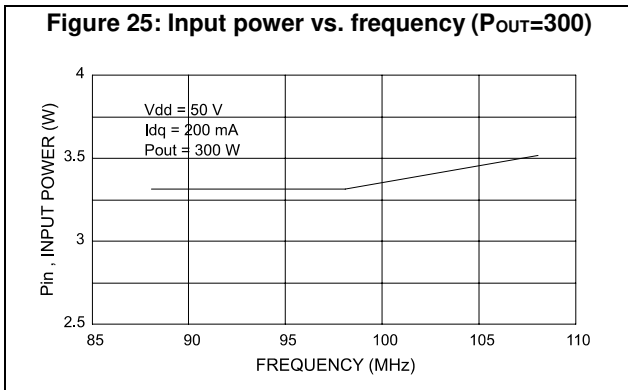

Table 8: 175 - 230 MHz circuit layout component part list

Component	Description
PCB	1/32" woven fiberglass 0.030 Cu, sides, $\epsilon_r = 4.8$
T1	50 Ohm flexible coax cable OD 0.06", 3" long. ferrite core NEOSIDE
T2, T3	9:1 transformer, 16.5 Ohm flexible coax cable 0.1", 3" long
T4, T5	4:1 transformer, 25 Ohm flexible coax cable OD 0.06", 5" long
C1	8.2 pF ceramic cap
C2, C3	100 pF ceramic cap
C4	2 - 18 pF chip cap
C5	47 pF ceramic cap
C6, C11	47 nF ceramic cap
C7	56 pF ATC chip cap
C8, C9, C13	470 pF ATC chip cap
C10	100 nF ceramic cap
C12	2 x 330 nF / 50 V cap
C14	10 nF / 63 V electrolytic cap
R1, R3	47 Ohm resistor
R2	6.8 kOhm chip resistor
R4	4.7 kOhm multi turn trim resistor
R5	8.2 kOhm / 5 W resistor
R6	3.3 kOhm / 5 W resistor
D1	6.8 V Zener diode
L1	20 nH inductor
L2	70 nH inductor
L3	30 nH inductor
L4	10 nH inductor
L5	15 nH inductor

9 Typical broadband data (88 - 108 MHz)



10 Test circuit 88-108 MHz

Figure 31: 88 - 108 MHz test circuit layout (engineering fixture)

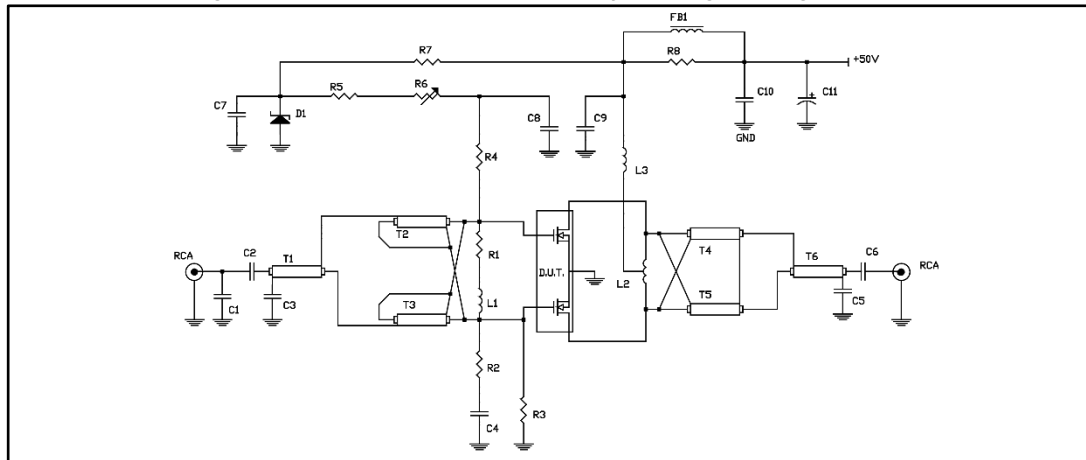

Table 9: 88 - 108 MHz circuit layout component part list

Component	Description
PCB	1/32" woven fiberglass 0.030 Cu, sides, $\epsilon_r = 4.8$
T1	50 Ohm flexible coax cable OD 0.06", 3" long
T2, T3	9:1 transformer, 25 Ohm flexible coax cable 0.1", 3.9" ferrite core NEOSIDE
T4, T5	4:1 transformer, 25 Ohm flexible coax cable OD 0.1", 5" long
T6	50 Ohm flexible coax cable OD 0.1", 5" long
FB1	vk200
C1	10 pF ceramic cap
C2, C3, C4, C7, C8	1 nF chip cap
C5, C6	1 nF ATC chip cap
C9	470 pF ceramic cap
C10	100 nF chip cap
C11	100 mF / 63 V electrolytic cap
R1	56 Ohm resistor
R2, R4	10 Ohm chip resistor
R3	10 kOhm resistor
R5	5.6 Ohm resistor
R6	10 kOhm, 10 turn trim resistor
R7	3.3 kOhm / 5 W resistor
R8	15 Ohm / 5 W resistor
D1	6.8 V Zener diode
L1	10 nH inductor
L2	40 nH inductor
L3	70 nH inductor

11 Marking, packing and shipping specifications

Table 10: Packing and shipping specifications

Order code	Packing	Pieces per tray	Dry pack humidity	V _{GS} and G _{FS} code	Lot code
SD2932W	Tube	15	< 10%	Not mixed	Not mixed

Figure 32: SD2932 marking layout

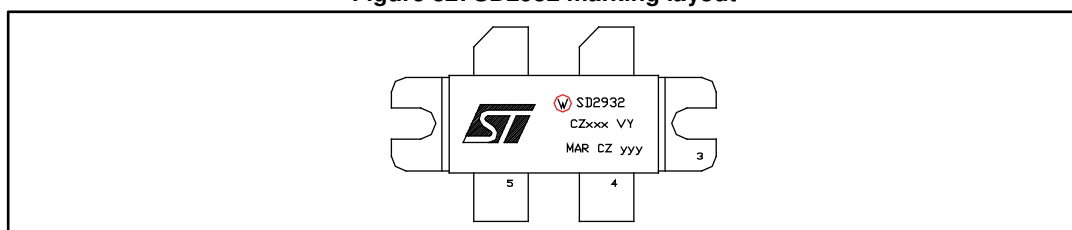

Table 11: Marking specifications

Symbol	Description
W	Wafer process code
CZ	Assembly plant
xxx	Last 3 digits of diffusion lot
VY	Diffusion plant
MAR	Country of origin
CZ	Test and finishing plant
y	Assembly year
yy	Assembly week

12 Package information

In order to meet environmental requirements, ST offers these devices in different grades of ECOPACK® packages, depending on their level of environmental compliance. ECOPACK® specifications, grade definitions and product status are available at: www.st.com. ECOPACK® is an ST trademark.

12.1 M244 package information

Figure 33: M244 (0.400 x .860 4L BAL N/HERM W/FLG) package outline

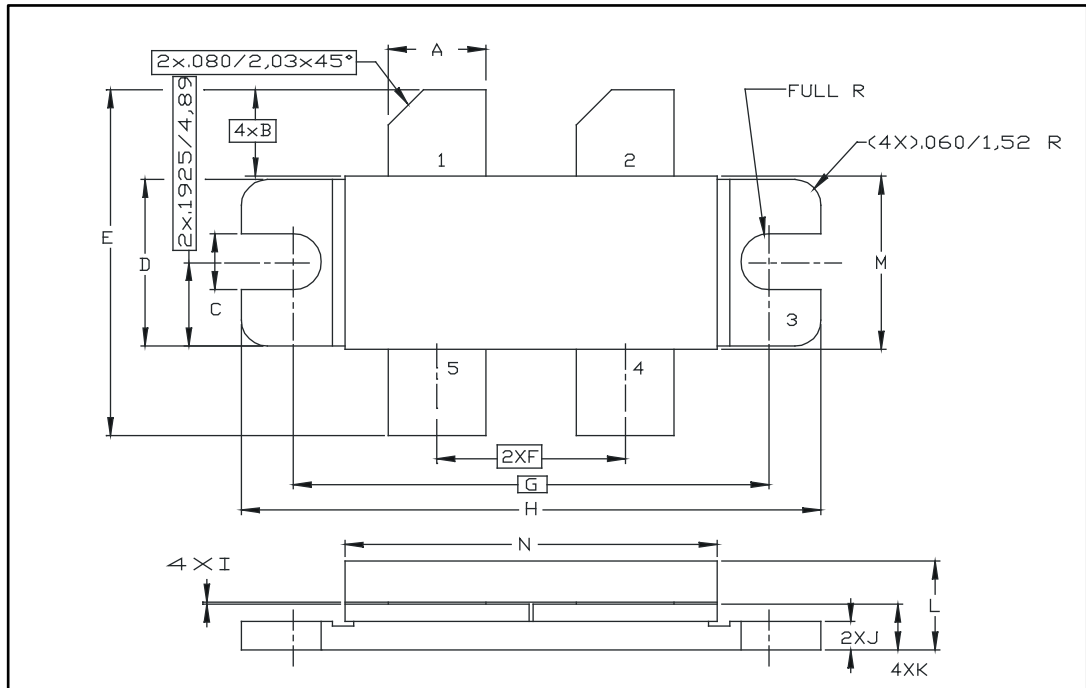

Table 12: M244 (0.400 x .860 4L BAL N/HERM W/FLG) package mechanical data

Dim.	mm		
	Min.	Typ.	Max.
A	5.59		5.84
B		5.08	
C	3.02		3.28
D	9.65		9.91
E	19.81		20.82
F	10.92		11.18
G		27.94	
H	33.91		34.16
I	0.10		0.15
J	1.52		1.78
K	2.59		2.84
L	4.83		5.84
M	10.03		10.34
N	21.59		22.10

13 Revision history

Table 13: Document revision history

Date	Revision	Changes
15-Jul-2004	5	
24-Jan-2006	6	Updated <i>Table 4: Static (per section)</i> .
23-Nov-2009	7	Inserted Δ_{VGS} in <i>Table 4: Static (per section)</i> .
31-Mar-2010	8	Added <i>Figure 7, Figure 8 and Figure 9</i> .
11-Jan-2012	9	Inserted <i>Chapter 12: Marking, packing and shipping specifications</i> . Minor text changes.
24-Nov-2016	10	Updated <i>Section 1.1: "Maximum ratings"</i> .

IMPORTANT NOTICE – PLEASE READ CAREFULLY

STMicroelectronics NV and its subsidiaries ("ST") reserve the right to make changes, corrections, enhancements, modifications, and improvements to ST products and/or to this document at any time without notice. Purchasers should obtain the latest relevant information on ST products before placing orders. ST products are sold pursuant to ST's terms and conditions of sale in place at the time of order acknowledgement.

Purchasers are solely responsible for the choice, selection, and use of ST products and ST assumes no liability for application assistance or the design of Purchasers' products.

No license, express or implied, to any intellectual property right is granted by ST herein.

Resale of ST products with provisions different from the information set forth herein shall void any warranty granted by ST for such product.

ST and the ST logo are trademarks of ST. All other product or service names are the property of their respective owners.

Information in this document supersedes and replaces information previously supplied in any prior versions of this document.

© 2016 STMicroelectronics – All rights reserved