



Chipsmall Limited consists of a professional team with an average of over 10 year of expertise in the distribution of electronic components. Based in Hongkong, we have already established firm and mutual-benefit business relationships with customers from,Europe,America and south Asia,supplying obsolete and hard-to-find components to meet their specific needs.

With the principle of “Quality Parts,Customers Priority,Honest Operation,and Considerate Service”,our business mainly focus on the distribution of electronic components. Line cards we deal with include Microchip,ALPS,ROHM,Xilinx,Pulse,ON,Everlight and Freescale. Main products comprise IC,Modules,Potentiometer,IC Socket,Relay,Connector.Our parts cover such applications as commercial,industrial, and automotives areas.

We are looking forward to setting up business relationship with you and hope to provide you with the best service and solution. Let us make a better world for our industry!



Contact us

Tel: +86-755-8981 8866 Fax: +86-755-8427 6832

Email & Skype: info@chipsmall.com Web: www.chipsmall.com

Address: A1208, Overseas Decoration Building, #122 Zhenhua RD., Futian, Shenzhen, China



RF power transistor the LdmoST family

Technical Literature

CUSTOM ATTRIBUTES

Alternate Identifier(s)	6733
Key process	Product Development
ISO Definition	Specification
Confidentiality Level	Public
Document Type	Technical Literature
Document Category	Datasheet
Document Family	
Original ID	
Original Repository	
Status	IN APPROVAL
Responsible	
Keywords	Technical Literature, 6733, Product Development, Specification, Datasheet, SD57060-01,

DOCUMENT HISTORY

Version	Release Date	Change Qualifier
Rev 7.2		Properties Changes
05/21/2013 AUTOMATIC REVALIDATION DATE WORKFLOW STARTED		

Draft - Draft - Draft

DOCUMENT APPROVAL

LABEL	USER FUNCTION	DATE
Camilleri Evelina	Document Controller	27-May-2013

Draft - Draft - Draft



SD57060-01

RF power transistor
the LdmoST family

Features

- Excellent thermal stability
- Common source configuration
- $P_{OUT} = 60W$ with 13dB gain @ 945MHz
- BeO free package
- In compliance with the 2002/95/EC european directive

Description

The SD57060-01 is a common source N-channel enhancement-mode lateral Field-Effect RF power transistor designed for broadband commercial and industrial applications at frequencies up to 1.0GHz. The SD57060-01 is designed for high gain and broadband performance operating in common source mode at 28V. It is ideal for base station applications requiring high linearity.

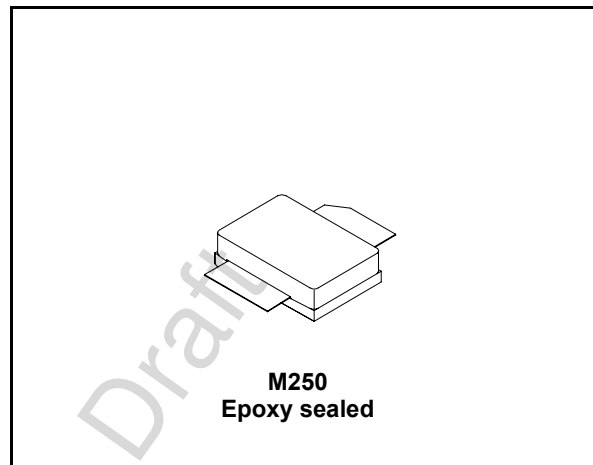

Figure 1. Pin connection

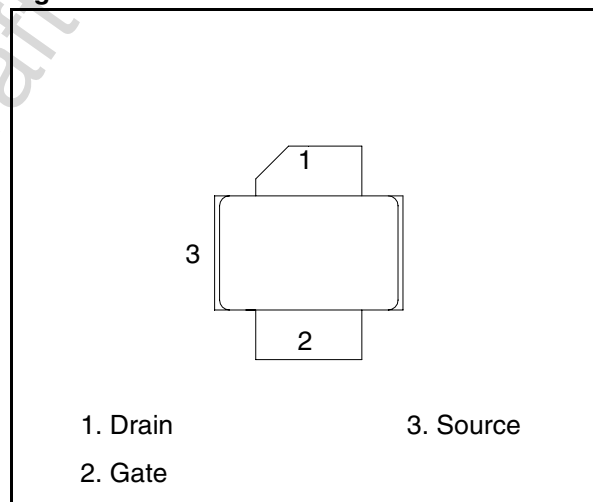

Table 1. Device summary

Order code	Package	Branding
SD57060-01	M250	SD57060-01

Contents

1	Electrical data	3
1.1	Maximum ratings	3
1.2	Thermal data	3
2	Electrical characteristics	4
2.1	Static	4
2.2	Dynamic	4
3	Impedance	5
4	Typical performance	6
5	Common source s-parameter	9
5.1	SD57060-01 ($V_{DS} = 13.5V$ $I_{DS} = 2A$)	9
5.2	SD57060 ($V_{DS} = 28V$ $I_{DS} = 2A$)	10
6	Test circuit	11
7	Text circuit layout	13
8	Package mechanical data	14
9	Revision history	16

SD57060-01

Electrical data

1 Electrical data

1.1 Maximum ratings

Table 1. Absolute maximum ratings ($T_{CASE} = 25^{\circ}C$)

Symbol	Parameter	Value	Unit
$V_{(BR)DSS}$	Drain-source voltage	65	V
V_{GS}	Gate-source voltage	± 20	V
I_D	Drain current	7	A
P_{DISS}	Power dissipation (@ $T_c = 70^{\circ}C$)	108	W
T_J	Max. operating junction temperature	200	$^{\circ}C$
T_{STG}	Storage temperature	-65 to + 150	$^{\circ}C$

1.2 Thermal data

Table 2. Thermal data

Symbol	Parameter	Value	Unit
R_{thJC}	Junction - case thermal resistance	1.1	$^{\circ}C/W$
$R_{thCS}^{(1)}$	Case-heatsink thermal resistance	0.5	$^{\circ}C/W$

1. Determined using a flat aluminum or copper heatsink with thermal compound applied (Dow Corning 340 or equivalent).

2 Electrical characteristics

$$T_{\text{CASE}} = +25\text{ }^{\circ}\text{C}$$

2.1 Static

Table 3. Static

Symbol	Test conditions		Min	Typ	Max	Unit
$V_{(\text{BR})\text{DSS}}$	$V_{\text{GS}} = 0\text{ V}$	$I_{\text{DS}} = 1\text{ mA}$	65			V
I_{DSS}	$V_{\text{GS}} = 0\text{ V}$	$V_{\text{DS}} = 28\text{ V}$			1	μA
I_{GSS}	$V_{\text{GS}} = 20\text{ V}$	$V_{\text{DS}} = 0\text{ V}$			1	μA
$V_{\text{GS(Q)}}$	$V_{\text{DS}} = 28\text{ V}$	$I_{\text{D}} = 100\text{ mA}$	2.0		5.0	V
$V_{\text{DS(ON)}}$	$V_{\text{GS}} = 10\text{ V}$	$I_{\text{D}} = 3\text{ A}$		0.7	0.8	V
G_{FS}	$V_{\text{DS}} = 10\text{ V}$	$I_{\text{D}} = 3\text{ A}$	2.5			mho
$C_{\text{ISS}}^{(1)}$	$V_{\text{GS}} = 0\text{ V}$	$V_{\text{DS}} = 28\text{ V}$		88		pF
C_{OSS}	$V_{\text{GS}} = 0\text{ V}$	$V_{\text{DS}} = 28\text{ V}$		44		pF
C_{RSS}	$V_{\text{GS}} = 0\text{ V}$	$V_{\text{DS}} = 28\text{ V}$		2.8		pF

1. Includes Internal Input Moscap.

2.2 Dynamic

Symbol	Test conditions		Min	Typ	Max	Unit
P_{OUT}	$V_{\text{DD}} = 28\text{ V}$	$I_{\text{DQ}} = 100\text{ mA}$	60			W
G_{PS}	$V_{\text{DD}} = 28\text{ V}$	$I_{\text{DQ}} = 100\text{ mA}$	13	15		dB
h_{D}	$V_{\text{DD}} = 28\text{ V}$	$I_{\text{DQ}} = 100\text{ mA}$	53	60		%
Load mismatch	$V_{\text{DD}} = 28\text{ V}$	$I_{\text{DQ}} = 100\text{ mA}$	5:1			VSW R

SD57060-01

Impedance

3 Impedance

Figure 2. Current conventions

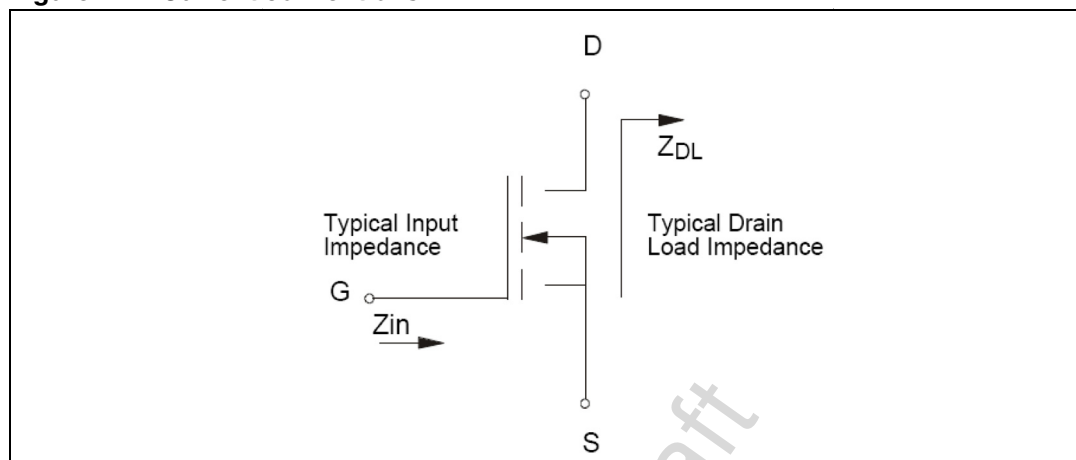

Table 4. Impedance data

Freq. (MHz)	$Z_{IN} (\Omega)$	$Z_{DL} (\Omega)$
925 MHz	$0.8 - j 0.095$	$1.5 + j 0.48$
945 MHz	$0.7 - j 0.05$	$1.6 + j 0.25$
960 MHz	$0.7 + j 0.1$	$1.7 + j 0.130$

4 Typical performance

Figure 3. Output power and power gain vs input power

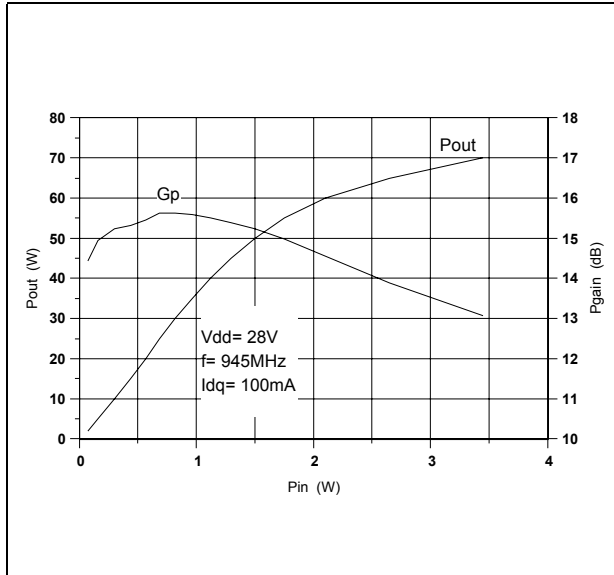

Figure 4. Output power and power gain vs input power

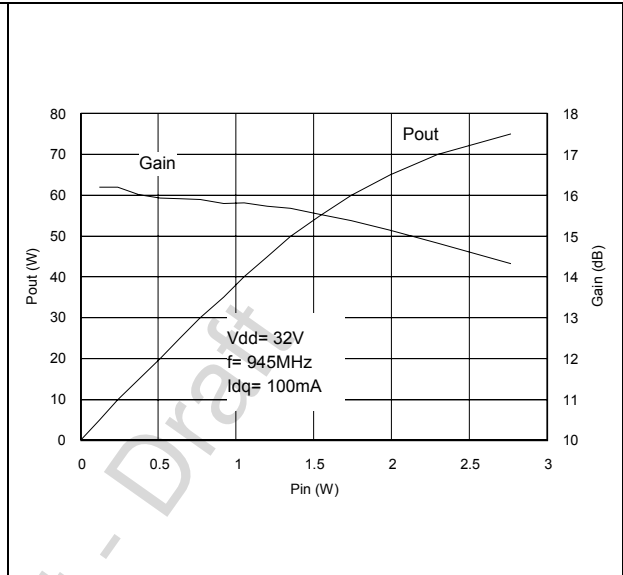

Figure 5. Efficiency vs output power

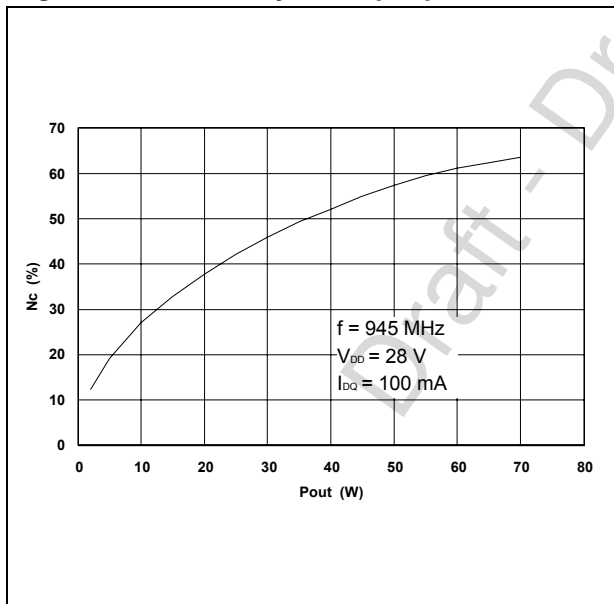
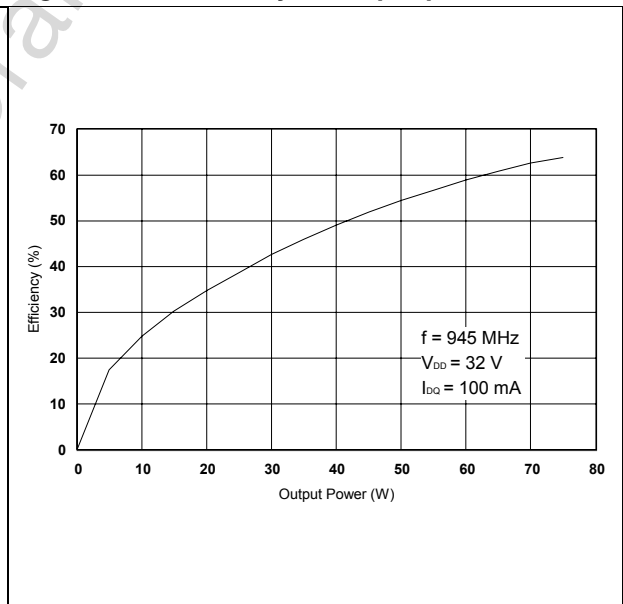

Figure 6. Efficiency vs output power



SD57060-01

Typical performance

Figure 7. Output power vs drain-source voltage

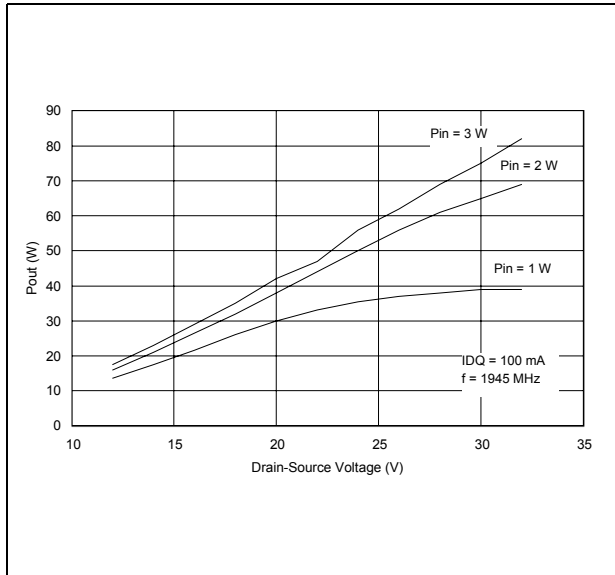

Figure 8. Intermodulation distortion vs output power

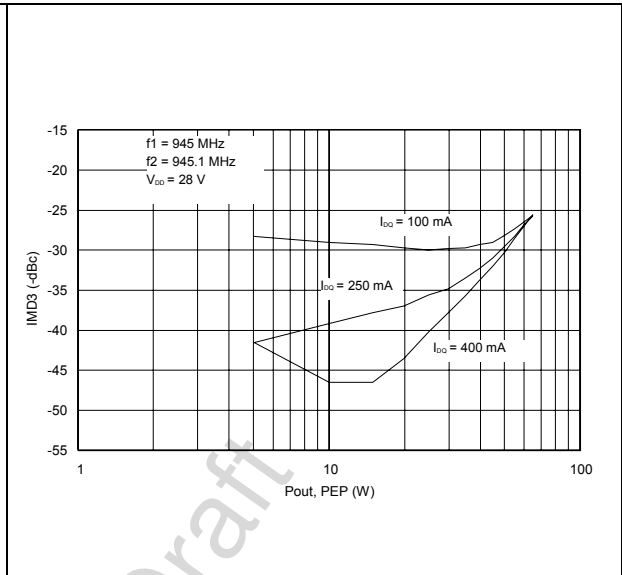

Figure 9. Power gain vs output power

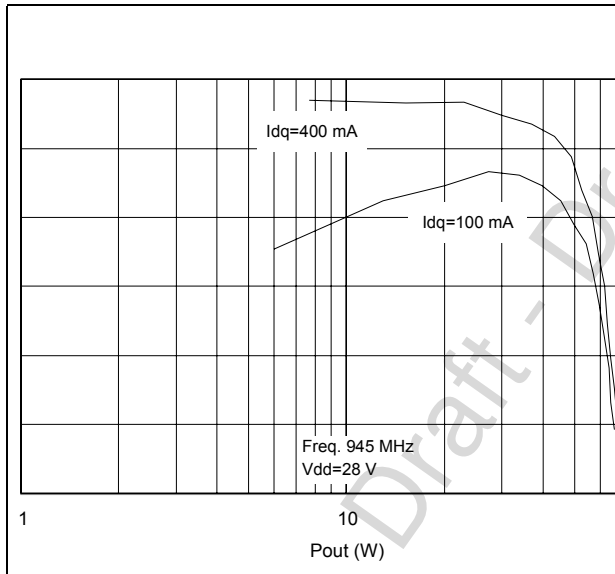
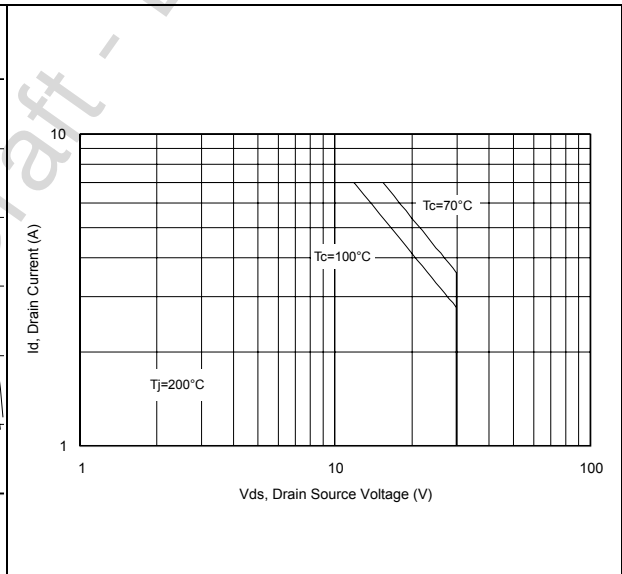

Figure 10. Safe operating area



Typical performance

SD57060-01

Figure 11. Capacitance vs drain-source voltage

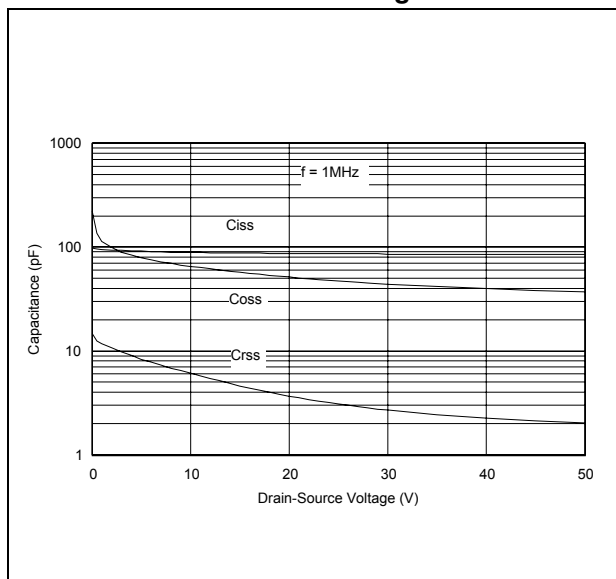

Draft - Draft - Draft



SD57060-01

Common source s-parameter

5 Common source s-parameter

5.1 SD57060-01 ($V_{DS} = 13.5V$ $I_{DS} = 2A$)

Table 5. S-parameter

FREQ (MHz)	s11 MAG	s11 ang	s21 MAG	s21 ang	s12 MAG	s12 ang	s22 MAG	s22 ang
50	0.896	-168.86	15.679	85.012	0.0116	-5.1128	0.796	-170.27
60	0.896	-169.3	14.859	84.592	0.0116	-5.4369	0.796	-170.49
70	0.869	-169.76	14.004	84.14	0.0116	-5.7912	0.797	-170.7
80	0.869	-170.23	13.122	83.644	0.0115	-6.0658	0.797	-170.9
90	0.897	-170.71	12.213	83.074	0.0115	-6.3789	0.798	-171.1
100	0.897	-171.19	11.285	82.404	0.0114	-6.8198	0.799	-171.29
150	0.9	-173.39	6.9575	76.841	0.0111	-9.6817	0.808	-171.96
200	0.905	-174.29	4.751	71.951	0.0103	-11.87	0.821	-171.79
250	0.912	-174.64	3.637	68.471	0.0097	-12.957	0.836	-171.36
300	0.92	-174.9	2.889	64.839	0.0089	-13.493	0.851	-171.03
350	0.927	-175.08	2.428	62.538	0.0083	-11.937	0.866	-170.76
400	0.934	-175.3	2.077	58.748	0.0077	-11.228	0.881	-170.6
450	0.941	-175.5	1.802	56.081	0.0071	-8.7753	0.894	-170.49
500	0.947	-175.73	1.592	51.84	0.0066	-7.5009	0.907	-170.47
550	0.952	-176.02	1.379	48.632	0.0059	-4.8834	0.917	-170.55
600	0.956	-176.29	1.221	45.777	0.0053	0.12909	0.927	-170.67
650	0.96	-176.6	1.049	42.778	0.0048	5.0249	0.936	-170.82
700	0.962	-176.9	0.924	42.212	0.0043	13.591	0.943	-170.94
750	0.965	-177.22	0.814	40.376	0.0039	22.729	0.95	-171.05
800	0.968	-177.51	0.723	41.348	0.0036	37.954	0.956	-171.14
850	0.97	-177.83	0.662	40.788	0.0037	51.305	0.961	-171.16
900	0.972	-178.19	0.6	41.719	0.0041	63.188	0.966	-171.24
950	0.974	-178.56	0.566	41.469	0.0047	73.463	0.971	-171.24
1000	0.975	-178.96	0.523	41.747	0.0055	80.707	0.974	-171.25
1050	0.976	-179.28	0.504	41.439	0.0064	88.27	0.977	-171.26
1100	0.978	-179.62	0.477	40.692	0.0074	92.504	0.979	-171.36
1150	0.979	-179.85	0.466	39.239	0.0084	96.743	0.981	-171.43
1200	0.981	-179.9	0.444	36.775	0.0097	98.282	0.982	-171.5
1250	0.982	-179.68	0.431	34.788	0.011	99.121	0.983	-171.58
1300	0.983	-179.52	0.408	31.862	0.0125	98.773	0.983	-171.71
1350	0.984	-179.35	0.395	30.219	0.0136	97.973	0.983	-171.86
1400	0.985	-179.24	0.382	26.465	0.0148	97.464	0.984	-171.94
1450	0.987	-179.13	0.365	23.869	0.0157	95.39	0.984	-171.98
1500	0.988	-179.09	0.351	21.267	0.0165	93.871	0.985	-171.98

Common source s-parameter

SD57060-01

5.2 SD57060 ($V_{DS} = 28V$ $I_{DS} = 2A$)

Table 6. S-parameter

Freq (MHz)	s11 MAG	s11 ang	s21 MAG	s21 ang	s12 MAG	s12 ang	s22 MAG	s22 ang
50	0.857	-159.69	22.757	85.934	0.0114	-3.8342	0.67	-161.72
60	0.86	-160.69	21.547	85.328	0.0113	-4.4852	0.672	-162.07
70	0.862	-161.73	20.287	84.672	0.0112	-5.1512	0.674	-162.41
80	0.865	-162.8	18.987	83.933	0.0111	-5.8379	0.677	-162.74
90	0.869	-163.89	17.65	83.083	0.011	-6.5533	0.679	-163.07
100	0.872	-164.98	16.286	82.083	0.011	-7.4226	0.683	-163.39
150	0.891	-169.66	9.9447	74.03	0.0103	-12.13	0.708	-164.66
200	0.905	-171.43	6.719	67.256	0.0094	-15.548	0.74	-164.87
250	0.915	-172.29	5.074	62.268	0.0086	-17.236	0.774	-164.99
300	0.926	-172.84	3.978	57.533	0.0077	-18.625	0.806	-163.35
350	0.935	-173.34	3.297	54.035	0.0069	-17.313	0.834	-165.82
400	0.943	-173.79	2.775	49.488	0.0061	-16.81	0.86	-166.35
450	0.951	-174.24	2.376	46.121	0.0054	-13.006	0.881	-166.85
500	0.957	-174.67	2.061	41.541	0.0048	-9.175	0.898	-167.35
550	0.962	-175.11	1.766	38.23	0.0041	-2.5323	0.913	-167.83
600	0.966	-175.53	1.546	35.173	0.0035	-7.641	0.925	-168.25
650	0.969	-175.95	1.32	32.548	0.0031	19.501	0.937	-168.57
700	0.972	-176.34	1.162	31.674	0.0031	34.423	0.946	-168.81
750	0.974	-176.75	1.021	29.983	0.0032	48.345	0.954	-168.93
800	0.976	-177.15	0.91	30.341	0.0035	62.927	0.96	-168.98
850	0.977	-177.57	0.826	29.318	0.004	74.982	0.967	-168.95
900	0.978	-177.98	0.749	29.508	0.0047	81.962	0.973	-168.88
950	0.979	-178.41	0.696	28.477	0.0054	87.332	0.978	-168.77
1000	0.979	-178.85	0.639	27.949	0.0063	90.913	0.982	-168.72
1050	0.98	-179.24	0.601	26.768	0.0072	95.707	0.984	-168.75
1100	0.981	-179.61	0.561	25.598	0.0082	98.95	0.985	-168.87
1150	0.981	-179.95	0.533	23.746	0.0094	101.25	0.986	-169.13
1200	0.982	-179.72	0.498	21.331	0.011	102.03	0.985	-169.64
1250	0.983	-179.44	0.472	19.005	0.012	102.21	0.981	-170.42
1300	0.984	-179.23	0.44	16.272	0.0131	101.78	0.976	-171.5
1350	0.985	-179.02	0.417	14.424	0.0143	100.61	0.969	-172.89
1400	0.986	-178.85	0.394	11.161	0.0156	99.505	0.96	-174.72
1450	0.986	-178.7	0.372	8.789	0.0163	97.699	0.949	-176.87
1500	0.986	-178.6	0.354	6.5533	0.0168	96.68	0.94	-178.58

6 Test circuit

Figure 12. Test circuit schematic

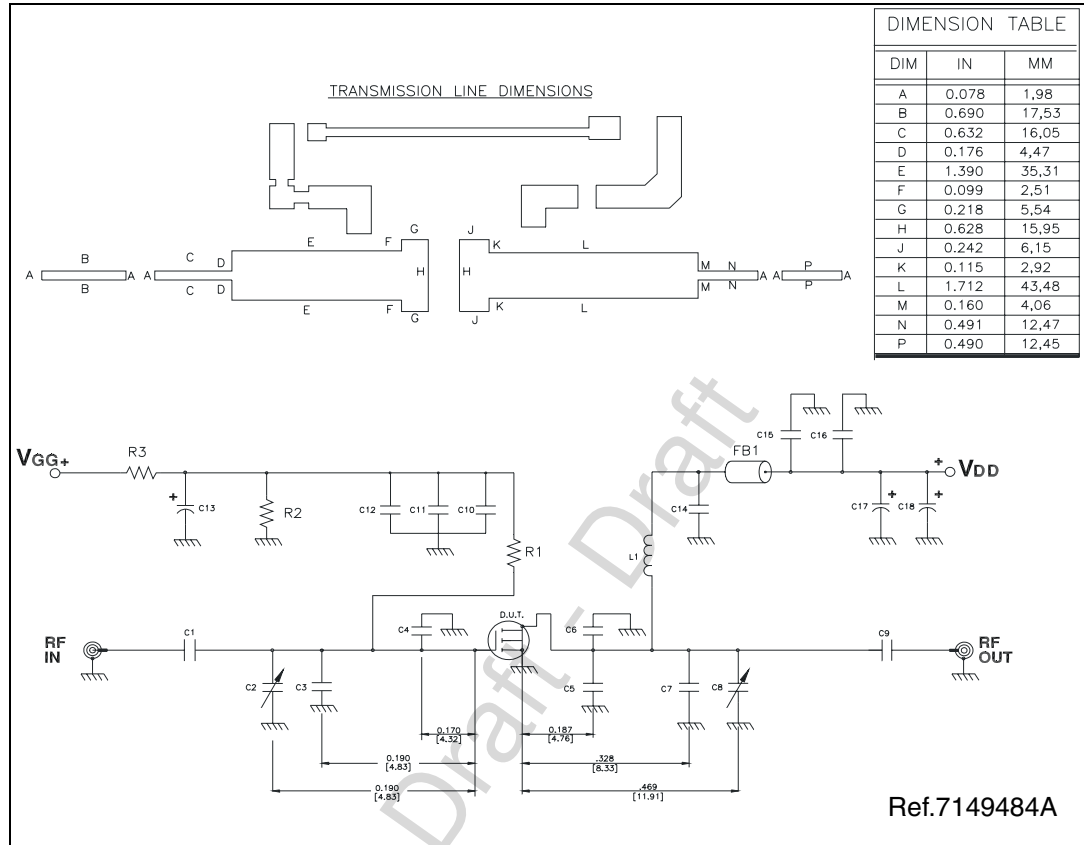

- 1 Dimensions at component symbols are reference for component placement.
- 2 Gap between ground & transmission line = 0.056 [1.42] +0.002 [0.05] -0.000 [0.00] typ.
- 3 Dimensions of input and output component from edge of transmission lines.

Test circuit

SD57060-01

Table 7. Test circuit component part list

Component	Description
L1	INDUCTOR, 5 TURNS AIR WOUND #18 AWG, ID = 0.125 [3.18] NYLON COATED MAGNET WIRE
FB1	SHIELD BEAD SURFACE MOUNT EMI
R1	1 K Ohm, SURFACE MOUNT CHIP RESISTOR
R2	18 K Ohm, SURFACE MOUNT CHIP RESISTOR
R3	10 K Ohm, SURFACE MOUNT CHIP RESISTOR
C1	36 pF ATC 100B SURFACE MOUNT CERAMIC CHIP CAPACITOR
C2,C8	0.8-8.0 pF GIGA TRIM VARIABLE CAPACITOR
C3	4.7 pF ATC 100B SURFACE MOUNT CERAMIC CHIP CAPACITOR
C4	11 pF ATC 100B SURFACE MOUNT CERAMIC CHIP CAPACITOR
C5	1.3 pF ATC 100B SURFACE MOUNT CERAMIC CHIP CAPACITOR
C6	7.5 pF ATC 100B SURFACE MOUNT CERAMIC CHIP CAPACITOR
C7	8.2 pF ATC 100B SURFACE MOUNT CERAMIC CHIP CAPACITOR
C9	100 pF ATC 100B SURFACE MOUNT CERAMIC CHIP CAPACITOR
C10,C14	47 pF ATC 100B SURFACE MOUNT CERAMIC CHIP CAPACITOR
C11,C15	10000 pF ATC 100B SURFACE MOUNT CERAMIC CHIP CAPACITOR
C12,C16	0.1 μ F / 500 V SURFACE MOUNT CERAMIC CHIP CAPACITOR
C13,C17	10 μ F / 50 V ALUMINIUM ELECTROLITIC RADIAL LEAD CAPACITOR
C18	220 μ F / 63 V V ALUMINIUM ELECTROLITIC RADIAL LEAD CAPACITOR
PCB	ULTRALAM 2000, WOVEN FIBERGLASS REINFORCED PTFE. 0.030" THK, $\epsilon_r= 2.55$, 2 OZ ED CU BOTH SIDES

7 Text circuit layout

Figure 13. Test fixture

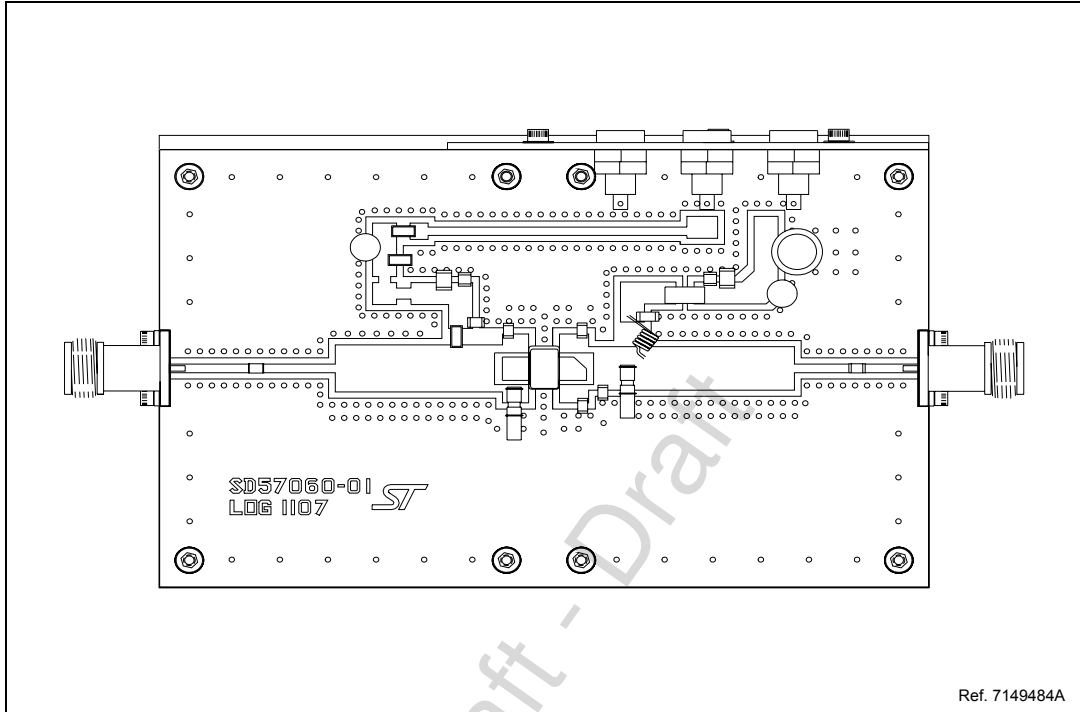
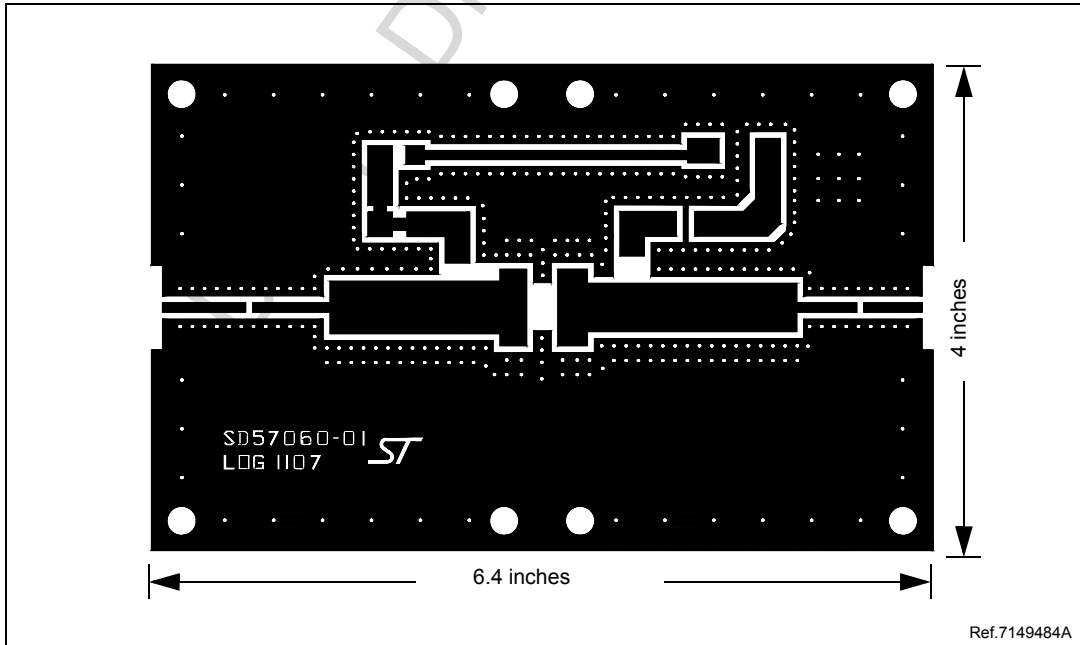

Figure 14. Test circuit photomaster



8 Package mechanical data

Table 8. M250 (.230 x .360 2L N/HERM W/FLG) mechanical data

Dim.	mm.			Inch		
	Min	Typ	Max	Min	Typ	Max
A	5.21		5.71	0.205		0.225
B	2.16		2.92	0.085		0.115
C	5.59		6.09	0.220		0.240
D	8.89		9.40	0.350		0.370
E	9.40		9.91	0.370		0.390
F	0.11		0.15	0.004		0.006
G	0.89		1.14	0.035		0.045
H	1.45		1.70	0.057		0.067
I	2.67		3.94	0.105		0.155

Figure 15. Package dimensions

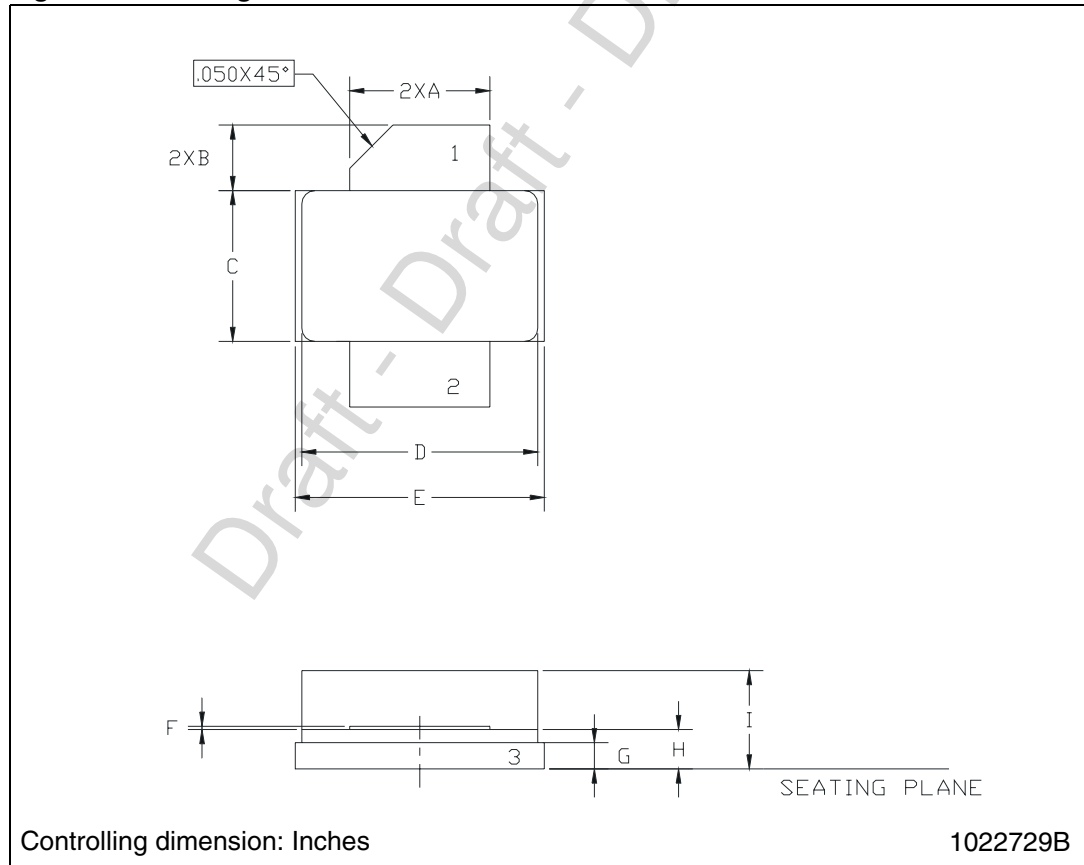

9 Revision history

Table 9. Document revision history

Date	Revision	Changes
24-Mar-2003	5	First Issue.
11-Jul-2007	6	Document reformatted, added lead free info
24-Aug-2007	7	Cover page title updated

Draft - Draft - Draft

SD57060-01

Please Read Carefully:

Information in this document is provided solely in connection with ST products. STMicroelectronics NV and its subsidiaries ("ST") reserve the right to make changes, corrections, modifications or improvements, to this document, and the products and services described herein at any time, without notice.

All ST products are sold pursuant to ST's terms and conditions of sale.

Purchasers are solely responsible for the choice, selection and use of the ST products and services described herein, and ST assumes no liability whatsoever relating to the choice, selection or use of the ST products and services described herein.

No license, express or implied, by estoppel or otherwise, to any intellectual property rights is granted under this document. If any part of this document refers to any third party products or services it shall not be deemed a license grant by ST for the use of such third party products or services, or any intellectual property contained therein or considered as a warranty covering the use in any manner whatsoever of such third party products or services or any intellectual property contained therein.

UNLESS OTHERWISE SET FORTH IN ST'S TERMS AND CONDITIONS OF SALE ST DISCLAIMS ANY EXPRESS OR IMPLIED WARRANTY WITH RESPECT TO THE USE AND/OR SALE OF ST PRODUCTS INCLUDING WITHOUT LIMITATION IMPLIED WARRANTIES OF MERCHANTABILITY, FITNESS FOR A PARTICULAR PURPOSE (AND THEIR EQUIVALENTS UNDER THE LAWS OF ANY JURISDICTION), OR INFRINGEMENT OF ANY PATENT, COPYRIGHT OR OTHER INTELLECTUAL PROPERTY RIGHT.

UNLESS EXPRESSLY APPROVED IN WRITING BY AN AUTHORIZED ST REPRESENTATIVE, ST PRODUCTS ARE NOT RECOMMENDED, AUTHORIZED OR WARRANTED FOR USE IN MILITARY, AIR CRAFT, SPACE, LIFE SAVING, OR LIFE SUSTAINING APPLICATIONS, NOR IN PRODUCTS OR SYSTEMS WHERE FAILURE OR MALFUNCTION MAY RESULT IN PERSONAL INJURY, DEATH, OR SEVERE PROPERTY OR ENVIRONMENTAL DAMAGE. ST PRODUCTS WHICH ARE NOT SPECIFIED AS "AUTOMOTIVE GRADE" MAY ONLY BE USED IN AUTOMOTIVE APPLICATIONS AT USER'S OWN RISK.

Resale of ST products with provisions different from the statements and/or technical features set forth in this document shall immediately void any warranty granted by ST for the ST product or service described herein and shall not create or extend in any manner whatsoever, any liability of ST.

ST and the ST logo are trademarks or registered trademarks of ST in various countries.

Information in this document supersedes and replaces all information previously supplied.

The ST logo is a registered trademark of STMicroelectronics. All other names are the property of their respective owners.

© 2007 STMicroelectronics - All rights reserved

STMicroelectronics group of companies

Australia - Belgium - Brazil - Canada - China - Czech Republic - Finland - France - Germany - Hong Kong - India - Israel - Italy - Japan - Malaysia - Malta - Morocco - Singapore - Spain - Sweden - Switzerland - United Kingdom - United States of America

www.st.com

