



Chipsmall Limited consists of a professional team with an average of over 10 year of expertise in the distribution of electronic components. Based in Hongkong, we have already established firm and mutual-benefit business relationships with customers from,Europe,America and south Asia,supplying obsolete and hard-to-find components to meet their specific needs.

With the principle of “Quality Parts,Customers Priority,Honest Operation,and Considerate Service”,our business mainly focus on the distribution of electronic components. Line cards we deal with include Microchip,ALPS,ROHM,Xilinx,Pulse,ON,Everlight and Freescale. Main products comprise IC,Modules,Potentiometer,IC Socket,Relay,Connector.Our parts cover such applications as commercial,industrial, and automotives areas.

We are looking forward to setting up business relationship with you and hope to provide you with the best service and solution. Let us make a better world for our industry!



Contact us

Tel: +86-755-8981 8866 Fax: +86-755-8427 6832

Email & Skype: info@chipsmall.com Web: www.chipsmall.com

Address: A1208, Overseas Decoration Building, #122 Zhenhua RD., Futian, Shenzhen, China



Description

The SensorShare™ SDAWIR01 and SDAWIR02 Demonstration Kits demonstrate using the IDT ZWIR4512 6LoWPAN Low-Power Wireless Module to communicate humidity, temperature, and flow sensor measurement data to a WiFi hub that allows a linked device to display and graph the measured data in real time. The kit uses the IDT HS3001 Humidity and Temperature Sensor and FS2012 Flow Sensor for the measurements.

The sensors are mounted in a 5cm clear plastic cube that contains a ZWIR4512 Wireless Module to communicate with the hub.

The 6LoWPAN-WiFi Hub and the Sensor Cube are powered by a separate AC/DC wall mount adapter.

The Hub utilizes a Raspberry Pi Zero W to provide the WiFi hub function interfaced to the ZWIR4512 Wireless Module. The Hub uses Raspbian LXDE Lightweight Desktop Environment. Raspbian is a Debian-based computer operating system for the Raspberry Pi. The Hub micro-SD card is fully loaded and ready for operation.

Kit Contents

- 6LoWPAN-WiFi Hub operating with a Raspberry Pi Zero W
- Sensor Cube
 - HS3001 Humidity Sensor
 - FS2012 Flow Sensor
 - ZWIR4512 6LoWPAN RF Module
- Hose; USB and HDMI adapters
- 2 AC/DC Wall-Mount Adapters depending on kit part code:
 - SDAWIR01 includes North American adapters
 - SDAWIR02 includes adapters for other locations

Features

- HS3001 Humidity and Temperature Sensor with I2C interface in the Sensor Cube
 - RH accuracy: $\pm 1.5\%$ RH typical (10% to 90% RH, 25°C)
 - Fast RH response time (typical: 6 seconds)
 - Temperature sensor accuracy: $\pm 0.2^\circ\text{C}$ (typical) (-10°C to +80°C)
- FS2012 Flow Sensor with I2C interface in the Sensor Cube
 - Gas or liquid mediums
 - Robust solid isolation technology
 - Resistant to surface contamination
 - No cavity to cause clogging
 - Resistant to vibration and pressure shock
- License-free 868/915 MHz frequency bands
- Unique EUI64 address
- 4 channels in EU mode; 10 channels in US mode
- Over-the-air update functionality in the Hub and Sensor Cube
- No software to install; apply power and WiFi link to the Hub to view measurements
- Multiple cubes with sensors installed can communicate with the Hub and have results displayed
- The Hub and Sensor Cube operate from 5.0V DC and micro-USB connector; wall-mount power supply adapters included
- The SDAWIR02 kit wall mount adapter has the common AC mains connection plugs used worldwide.
- For further details, see the datasheets for the IDT products used in this demonstration kit, which are located on-line:
 - ZWIR4512: www.idt.com/ZWIR4512
 - FS2012: www.idt.com/FS2012
 - HS3001: www.idt.com/HS3001

SDAWIR01 Demonstration Kit



SensrShare™
By Integrated Device Technology

Important Notes

Disclaimer

Integrated Device Technology, Inc. and its affiliated companies (herein referred to as "IDT") shall not be liable for any damages arising out of defects resulting from

- (i) delivered hardware or software
- (ii) non-observance of instructions contained in this manual and in any other documentation provided to user, or
- (iii) misuse, abuse, use under abnormal conditions, or alteration by anyone other than IDT.

TO THE EXTENT PERMITTED BY LAW, IDT HEREBY EXPRESSLY DISCLAIMS AND USER EXPRESSLY WAIVES ANY AND ALL WARRANTIES, WHETHER EXPRESS, IMPLIED, OR STATUTORY, INCLUDING, WITHOUT LIMITATION, IMPLIED WARRANTIES OF MERCHANTABILITY AND OF FITNESS FOR A PARTICULAR PURPOSE, STATUTORY WARRANTY OF NON-INFRINGEMENT, AND ANY OTHER WARRANTY THAT MAY ARISE BY REASON OF USAGE OF TRADE, CUSTOM, OR COURSE OF DEALING.

Restrictions in Use

IDT's SDAWIR01/SDAWIR02 Demonstration Kit consisting of the 6LoWPAN-WiFi Hub, Sensor Cube(s), AC/DC Wall Mount Adapters, Hose; USB and HDMI adapters and the *IDT Demo Software* are designed to provide a quick setup for taking Flow, RH% and temperature measurements with the FS2012 and HS3001 only. IDT's SDAWIR01/SDAWIR02 Demonstration Kits and *IDT Demo Software* must not be used for any mission-critical applications, end-customer products, or measurement reference source.

Contents

1.	Setup	4
1.1	Computer Requirements	4
1.2	Kit Connections and Power Switch	4
1.3	Kit Power-On and Operation	5
1.4	Kit Power Off	6
1.5	Setting the Wireless Frequency Band for the ZWIR4512	6
1.6	Altering the Cube Function and Performing a Reset	6
1.7	Operating with Only the HS3001 Sensor or Only the FS2012 Sensor	7
2.	Usage Guide	7
2.1	The Browser Display	7
2.2	The Browser Registration Display	7
2.3	The Measurement Control Menu	8
3.	Hub and Cube Firmware Update	9
4.	Ordering Information	9
5.	Revision History	10

List of Figures

Figure 1. 6LoWPAN-WiFi Hub and Sensor Cube Connections	4
Figure 2. Bottom View of Sensor Cube	4
Figure 3. Sensor Measurement Display	5
Figure 4. Band Selection Menu	6
Figure 5. Overview of the Browser Display	7
Figure 6. Browser Registration Display Example	7
Figure 7. Measurement Control Menu	8

1. Setup

1.1 Computer Requirements

Any device that can link to a WiFi hub and execute Java® script can display and graph the measured the sensor data from the SDAWIR01/02 Kit. This has been evaluated and confirmed for many smart phones, tablets, and PCs using one of the various internet browsers. There is no software to download or install on the computer or smart phone.

1.2 Kit Connections and Power Switch

Figure 1. 6LoWPAN-WiFi Hub and Sensor Cube Connections

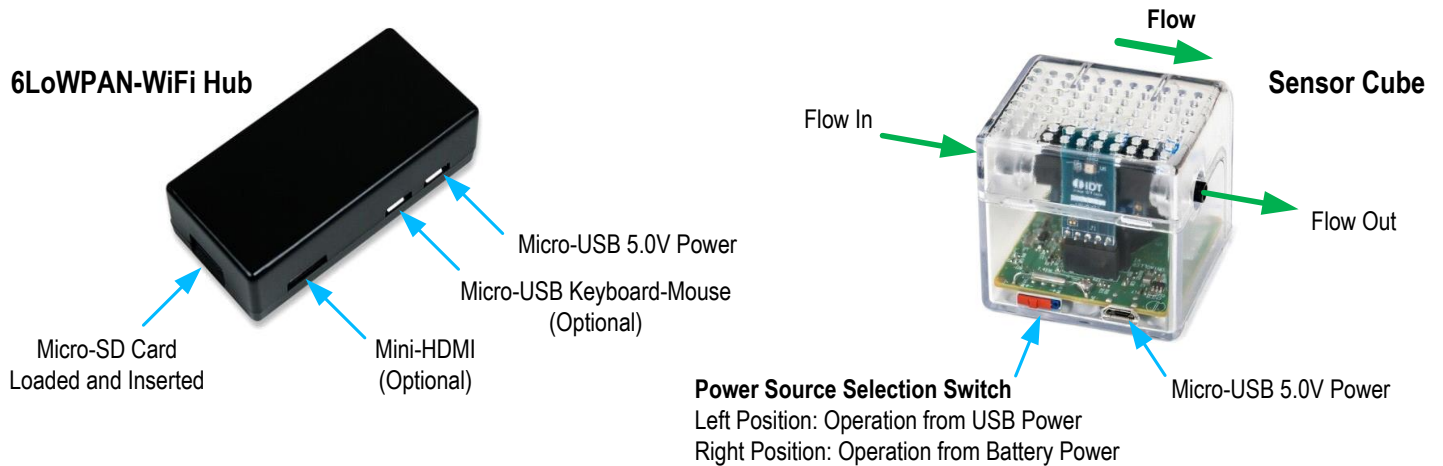
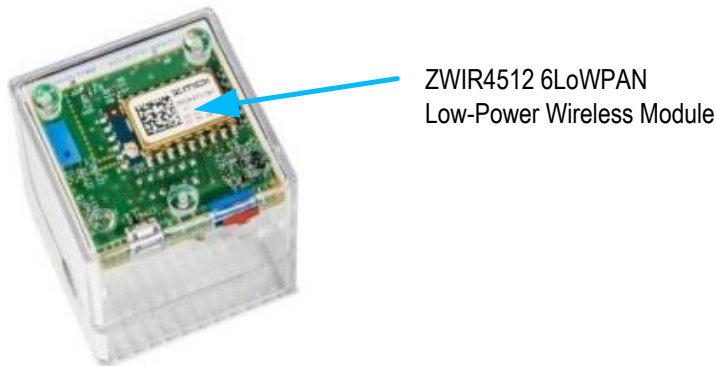

Figure 2. Bottom View of Sensor Cube



The Hub is always operated from the AC/DC Wall-Mount Adapter, which is included in this kit.

If the FS2012 Flow Sensor is included in the Sensor Cube, the Sensor Cube must operate from the AC/DC Wall-Mount Adapter. If the FS2012 is removed and only the HS3001 Humidity Temperature Sensor is used, the Sensor Cube can function using only the internal batteries or using the adapter. The internal battery holder is for two CR2032 coin cell batteries, which are not included in the kit.

The optional connections permit the user to operate the Raspberry PI Zero with its Linux-like operating system. These connections are not required for the Hub application. If used, the optional connections do not interfere with the Hub's functionality.

1.3 Kit Power-On and Operation

Follow these procedures for setting up the Hub and Sensor Cube:

- Set up the user's computer device (PC, smart phone with WiFi, or tablet) as needed for use with the kit.
- Power-up the Hub. The boot process will begin, which takes about 1.6 minutes
- Next, link the user's computer device to the Hub, which is named "ISG_Demo." There is no password or other login needed.
- With the Sensor Cube's power source selection switch in the battery-powered position (see Figure 1), connect the USB power and then switch to the USB powered position to power-up the Sensor Cube. The blue LEDs in the Sensor Cube should begin to flash. The LED on the FS2012 will light to indicate it is powered and operating.
- The two LEDs on the main circuit board indicate that a measurement is being read from the I2C devices (FS2012 and HS3001) and communication is occurring with the Hub on the 6LoWPAN wireless link.
- If more Sensor Cubes are available, they may also be powered at this time and they will also appear in the browser.
- Open the internet browser on the WiFi-linked computer device. Navigate to <http://demo.isg/>

After a few seconds needed for the automatic download of the required Java script, the screen should display the Sensor Cube's sensor information and the actual sensor measurements (see Figure 3). The internet browser might store prior information, so it might be necessary to refresh the browser to purge prior information. If the Hub has not been initialized to a wireless frequency band, the browser screen will appear as shown in section 1.5. In this case, follow the instructions in section 1.5 to properly set the wireless frequency band.

Figure 3. Sensor Measurement Display

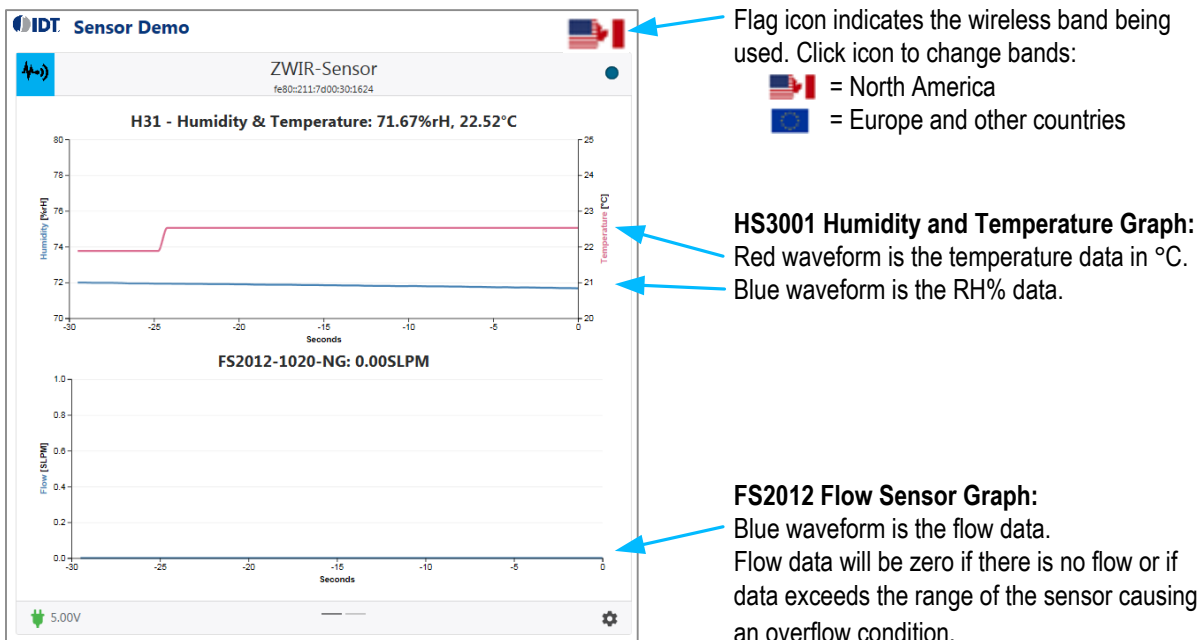

The measurement display has the following features:

- The horizontal time axis can be changed from 30 seconds to 600 seconds with the user's mouse wheel.
- The vertical axes are auto-scaled.
- As new measurements occur, the previous data points scroll to the left and then are off the graph.
- The current digital value is shown above each graph.
- If the Sensor Cube is not operating or not linked to the Hub, only the top line with the IDT logo and Sensor Demo appears.

1.4 Kit Power Off

There is no special shutdown or power off sequence needed. Just remove power from the Hub and Sensor Cube.

1.5 Setting the Wireless Frequency Band for the ZWIR4512

The upper-right corner of the sensor display shows the wireless band being used. See section 1.3. This icon can be clicked on to change the wireless band. The menu will take several seconds to load, and the browser will then show the band selection information and menu options (see Figure 4). The delay is because the Python interpreter must enable in the Raspberry Pi and the browser information must be received from the Hub.

Figure 4. Band Selection Menu

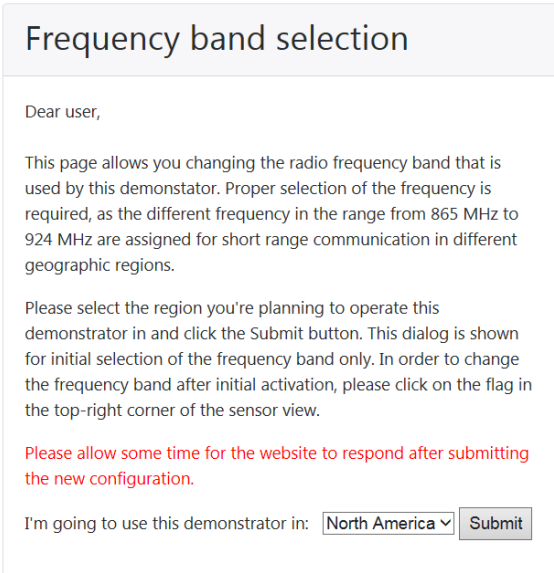

Frequency band selection

Dear user,

This page allows you changing the radio frequency band that is used by this demonstrator. Proper selection of the frequency is required, as the different frequency in the range from 865 MHz to 924 MHz are assigned for short range communication in different geographic regions.

Please select the region you're planning to operate this demonstrator in and click the Submit button. This dialog is shown for initial selection of the frequency band only. In order to change the frequency band after initial activation, please click on the flag in the top-right corner of the sensor view.

Please allow some time for the website to respond after submitting the new configuration.

I'm going to use this demonstrator in:

Select the region in the menu: “North America” for the higher frequency wireless band or “Europe” for the lower frequency band. Click on “Submit” to begin the change. The change will take about 60 seconds. Depending on the browser, the browser may need to be refreshed.

The operating Cube will find the communication link is broken and will then search both wireless bands to determine if the Cube can link to the Hub. The Cube follows the Hub’s selected band. The Cube does this wireless band search every time the Cube is powered up.

The Hub retains the previously set wireless band settings when powered up.

1.6 Altering the Cube Function and Performing a Reset

There is a reed switch located in front of the battery holder on the opposite side of the Sensor Cube relative to the switch and USB power connector. This reed switch can be activated with a magnet.

- Activation for less than 3 seconds resets the Sensor Cube.
- Activation for more than 3 seconds sets the Sensor Cube to the Always-on Mode, even if the battery is used. The LEDs show the activation status. For the first 3 seconds, both LEDs are always on; then one of the LEDs starts flashing rapidly, indicating that Always-on Mode is active.
- To exit the Always-on Mode, reset the Sensor Cube or cycle the power.

1.7 Operating with Only the HS3001 Sensor or Only the FS2012 Sensor

When the Sensor Cube is powered, the I2C addresses are scanned for the sensors that are connected. The kit is supplied with two sensors, but either one can be removed. In this case, the Sensor Cube will only report the actual sensor installed.

The FS2012 Flow Sensor power requirements are higher, so it is not intended for battery operation. The HS3001 Humidity Sensor is fully functional using only battery power. The Sensor Cube requires two CR2032 3V lithium coin cell batteries.

2. Usage Guide

2.1 The Browser Display

Figure 5. Overview of the Browser Display

Click here to contract or expand the sensor group.

IPv6 address of the Sensor Cube

Flashes each time a new set of data is logged.

Input DC voltage operating the module: the USB voltage or the battery voltage. The icon will indicate if the Sensor Cube interprets the voltage as a USB source or a battery source. The battery will be > 5.2V.

Click here to open the menu to control the measurements.

Click here to see the 6LoWPAN registration information.

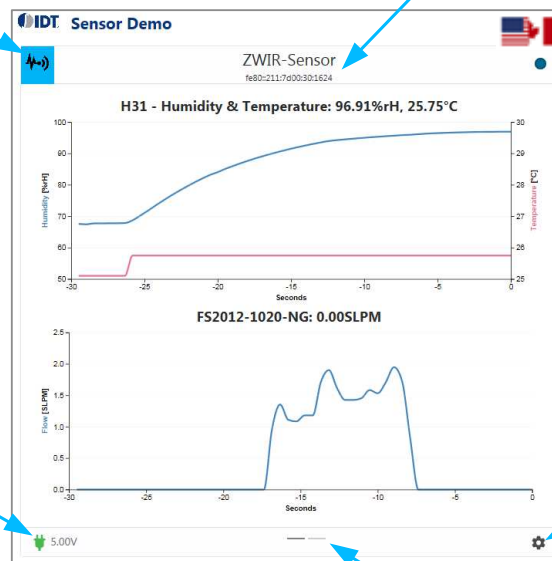

2.2 The Browser Registration Display

The browser logs the date and time when the Sensor Cube is linked to the Hub. The example shows the Cube was turned off and on, resulting in three different registrations. This history is reset when the browser is terminated.

Figure 6. Browser Registration Display Example

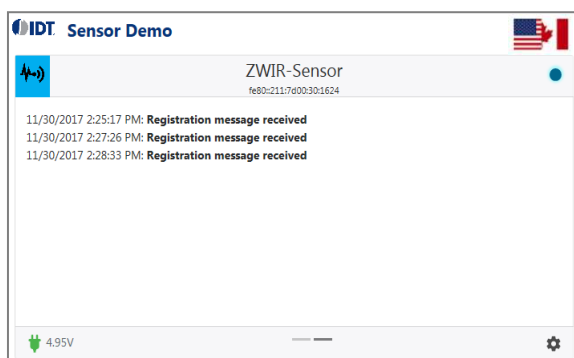

2.3 The Measurement Control Menu

The control menu can be opened in the browser. This provides some read-only information and permits controlling the measurements and display information. These measurement commands are wireless inputs to the Sensor Cube.

There are two sets of control information: one for USB power and one for battery power in sequence in the control menu (See Figure 7). The control information allows adjusting measurement parameters to reduce power consumption; for example, only sending pertinent information.

Figure 7. Measurement Control Menu

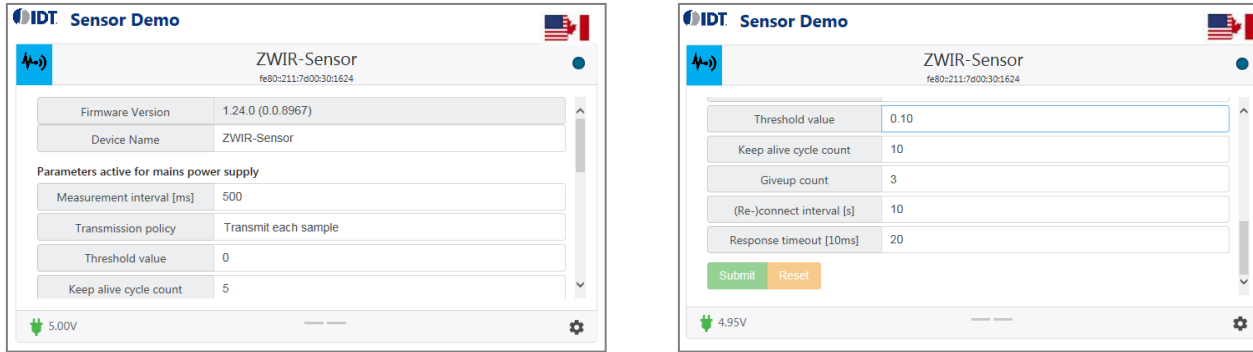

Use the scroll bar on the right of the menu to view all the features. The buttons at the bottom of the menu can be used to send new settings or reset settings to the previous conditions. If the settings are changed, the new settings are stored in the Sensor Cube but are not stored in the browser. Table 1 gives the descriptions for the menu items. Items that are R/W can be changed by the user.

For the Sensor Cubes with two sensors, the following settings have no practical meaning and are ignored:

- Transmission Policy: Transmit on relative change
- Transmission Policy: Transmit on absolute change
- Transmission Policy: Transmit on above threshold
- Transmission Policy: Transmit on below threshold
- Threshold Value

For Sensor Cubes with single sensors and two or more parameters being measured, this applies to the first reading only.

Table 1. Measurement Control Menu Settings

Menu Item	Options	Description	R/W
Firmware Version	–	Version of the Sensor Cube firmware.	R
Device Name	–	Sensor Cube name.	R
Measurements Interval (ms)	–	The time in ms between the triggers for new readings.	R/W
Transmission Policy	Transmit each sample	All measurements are transmitted.	R/W
	Transmit on relative change	If $(\text{abs}((P - M) / P) > T)$, then send. ^[a]	R/W
	Transmit on absolute change	If $(\text{abs}(P - M) > T)$ then send. ^[a]	R/W
	Transmit on above threshold	Measurements continue at the measurement interval but are only sent when the results are above the threshold value.	R/W
	Transmit on below threshold	Measurements continue at the measurement interval but are only sent when the results are below the threshold value.	R/W

Menu Item	Options	Description	R/W
Threshold Value	–	Value to be used as the threshold for the “Transmission Policy” setting.	R/W
Keep-Alive Cycle Count	–	When transmission policy is NOT “Transmit each sample,” this value specifies the maximum number of measurement cycles allowed before a measurement is transmitted by the Sensor Cube. This is independent of other policy rules.	R/W
Give-up Count	–	The number of consecutive communication cycle failures that can occur before the link to the Hub is considered broken.	R/W
(Re-)Connect Interval (s)	–	When the linkage to the Hub is lost, this is the time in seconds that Sensor Cube will remain idle between attempts to link to the Hub.	R/W
Response Timeout (10ms)	–	The Sensor Cube sends information to the Hub and waits this amount of time in 10ms increments to receive an acknowledgment back from the Hub before deeming this a failed communication cycle.	R/W

[a] P is the last value that has been transmitted successfully to the Hub; M is the current measurement result; and T is the value configured in “Threshold Value.”

3. Hub and Cube Firmware Update

IDT might provide updates to the Hub and Cube in the future. The update will be available on the IDT web site (see last page) and will be an .exe file that is executed to perform the update.

The normal procedure will be to use WiFi to link to the Hub and have the Hub linked to the Sensor Cubes. The Sensor Cubes should be on USB power for this procedure. Execute the .exe. Then all the updates will be performed automatically. No wired connections are needed.

4. Ordering Information

Orderable Part Number	Description
SDAWIR01	SDAWIR01 Demonstration Kit, including the 6LoWPAN-WiFi Hub, Sensor Cube with HS3001 Sensor Module, FS2012 Flow Sensor, and ZWIR4512 Wireless Module, two AC/DC Wall Adapters with North American Plug
SDAWIR02	SDAWIR02 Demonstration Kit, including the 6LoWPAN-WiFi Hub, Sensor Cube with HS3001 Sensor Module, FS2012 Flow Sensor, and ZWIR4512 Wireless Module, two AC/DC Wall Adapters with common world plug options

5. Revision History

Revision Date	Description of Change
January 24, 2018	Addition of "SensorShare" logo on page 1 and addition of "SensorShare™" in the first sentence on page 1.
December 19, 2017	Minor edits.
December 13, 2017	Initial release.



Corporate Headquarters

6024 Silver Creek Valley Road
 San Jose, CA 95138
www.IDT.com

Sales

1-800-345-7015 or 408-284-8200
 Fax: 408-284-2775
www.IDT.com/go/sales

Tech Support

www.IDT.com/go/support

DISCLAIMER Integrated Device Technology, Inc. (IDT) and its affiliated companies (herein referred to as "IDT") reserve the right to modify the products and/or specifications described herein at any time, without notice, at IDT's sole discretion. Performance specifications and operating parameters of the described products are determined in an independent state and are not guaranteed to perform the same way when installed in customer products. The information contained herein is provided without representation or warranty of any kind, whether express or implied, including, but not limited to, the suitability of IDT's products for any particular purpose, an implied warranty of merchantability, or non-infringement of the intellectual property rights of others. This document is presented only as a guide and does not convey any license under intellectual property rights of IDT or any third parties.

IDT's products are not intended for use in applications involving extreme environmental conditions or in life support systems or similar devices where the failure or malfunction of an IDT product can be reasonably expected to significantly affect the health or safety of users. Anyone using an IDT product in such a manner does so at their own risk, absent an express, written agreement by IDT.

Integrated Device Technology, IDT and the IDT logo are trademarks or registered trademarks of IDT and its subsidiaries in the United States and other countries. Other trademarks used herein are the property of IDT or their respective third party owners. For datasheet type definitions and a glossary of common terms, visit www.idt.com/go/glossary. All contents of this document are copyright of Integrated Device Technology, Inc. All rights reserved.