



Chipsmall Limited consists of a professional team with an average of over 10 year of expertise in the distribution of electronic components. Based in Hongkong, we have already established firm and mutual-benefit business relationships with customers from,Europe,America and south Asia,supplying obsolete and hard-to-find components to meet their specific needs.

With the principle of “Quality Parts,Customers Priority,Honest Operation,and Considerate Service”,our business mainly focus on the distribution of electronic components. Line cards we deal with include Microchip,ALPS,ROHM,Xilinx,Pulse,ON,Everlight and Freescale. Main products comprise IC,Modules,Potentiometer,IC Socket,Relay,Connector.Our parts cover such applications as commercial,industrial, and automotives areas.

We are looking forward to setting up business relationship with you and hope to provide you with the best service and solution. Let us make a better world for our industry!



## Contact us

Tel: +86-755-8981 8866 Fax: +86-755-8427 6832

Email & Skype: info@chipsmall.com Web: www.chipsmall.com

Address: A1208, Overseas Decoration Building, #122 Zhenhua RD., Futian, Shenzhen, China





# SDC-EC25N

## HARDWARE INTEGRATION GUIDE VERSION 2.1

global solutions: local support™

Americas: +1-800-492-2320 Option 2

Europe: +44-1628-858-940

Hong Kong: +852-2923-0600

[www.lairdtech.com/wireless](http://www.lairdtech.com/wireless)

## REVISION HISTORY

Version	Revision Date	Change Description	Approved By
0.1	05/10/10	Preliminary version of the EC25N HIG.	Ron Seide
1.01	06/03/10	Added/revised antenna patterns	Ron Seide
2.0	11/08/12	Updated formatting (Laird).	Ron Seide
2.1	01/31/13	Updated Channel and Frequency data.	Ron Seide

## CONTENTS

Scope .....	4
Block Diagram .....	5
Specifications.....	5
Pin Definitions .....	10
Mechanical Specifications .....	11
Regulatory .....	12
Antenna Characteristics .....	12
Documentation Requirements .....	13

## SCOPE

This document describes key hardware aspects of the Summit SDC-EC25N wireless LAN radio card. This document is intended to assist device manufacturers and related parties with integration of this card into their host devices. Data in this document are drawn from a number of sources and includes information found in the Broadcom BCM4322 data sheet issued in August of 2008.

## OPERATIONAL DESCRIPTION

This device is an SDC-EC25N, an IEEE 802.11n-compliant Peripheral Components Interconnect Express (PCIe) Card which operates in the 2.4 GHz and 5 GHz portions of the radio frequency spectrum. The device is compliant with IEEE 802.11a, 802.11b, 802.11g, and 802.11n standards using Direct Sequence Spread Spectrum and Orthogonal Frequency Division Multiplexing. The device supports all 802.11a, 802.11b, and 802.11g data rates and select 802.11n data rates and automatically adjusts data rates and operational modes based on various environmental factors.



When operating on channels in the UNII-2 and UNII-2 Extended bands that are in the 5GHz portion of the frequency spectrum and are subject to Dynamic Frequency Selection requirements, the SDC-EC25N fully conforms to applicable regulatory requirements. In the event that specified types of radar are detected by the network infrastructure, the SDC-EC25N fully conforms with commands from the infrastructure for radar avoidance.

The SDC-EC25N is compliant with 32-bit PCIe Express Card mechanical specifications and interfaces to host devices via a 26-pin connector. The device is based on the Broadcom BCM4322 chip which is an 802.n compliant integrated device providing a Media Access Controller (MAC), a Physical Layer Controller (PHY or baseband processor), and fully integrated dual-band antenna that provides 2x2 antenna and MIMO support. The frequency stability for both 2.4 GHz (802.11b and 802.11g) and 5 GHz (802.11a) operation is +/- 20 ppm.

The SDC-EC25N has its own RF shielding and does not require shielding provided by the host device into which it is installed in order to maintain compliance with applicable regulatory standards. As such, the device may be tested in a standalone configuration via an extender card.

The device buffers all data inputs so that it will comply with all applicable regulations even in the presence of over-modulated input from the host device. Similarly, the SDC-EC25N incorporates power regulation to comply with all applicable regulations even when receiving excess power from the host device.

The SDC-EC25N incorporates an antenna that supports dual band diversity when operating in 802.11a, 802.11b and 802.11g modes and 2 x 2 MIMO support when operating in 802.11n mode.

The device is labeled with all applicable regulatory information in a manner that's compliant with all regulatory standards. Regulatory operational requirements are included with this document and are to be incorporated into the operating manual of any device into which the SDC-EC25N is installed. The EC25N is designed for installation into mobile devices such as notebook computers which typically operate at distances greater than 20 cm from the human body. See "[Documentation Requirements](#)" for more information.

## BLOCK DIAGRAM

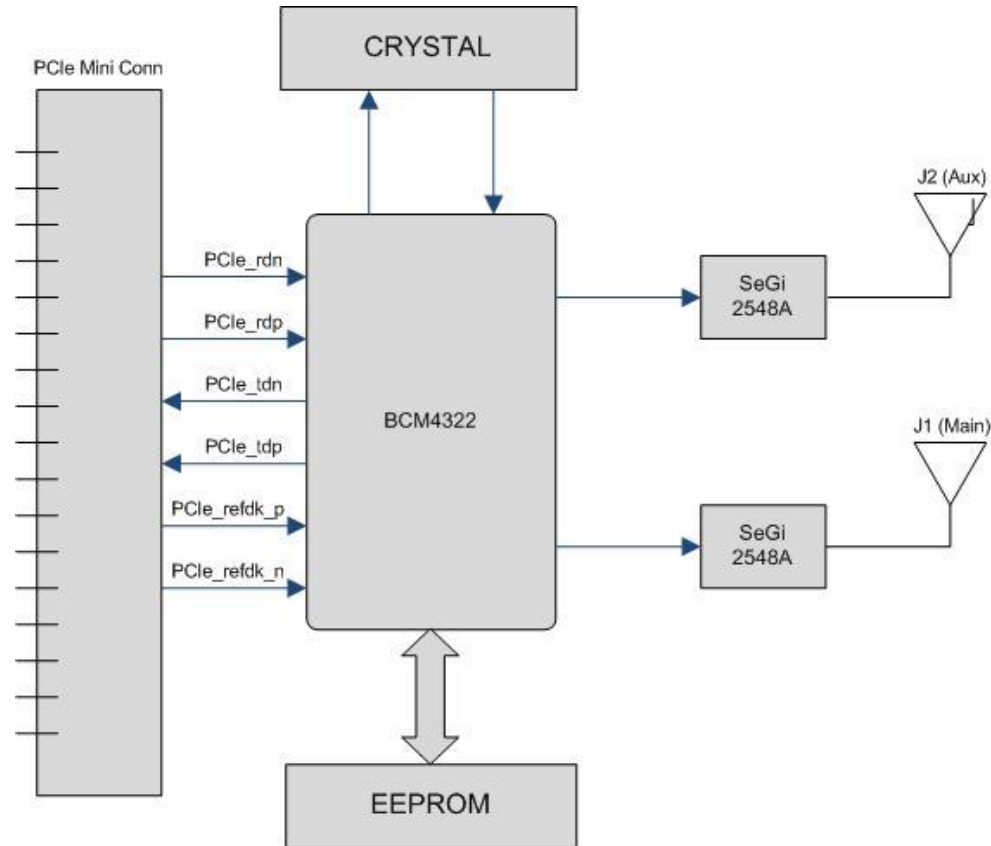

## SPECIFICATIONS

Feature	Description
System Interface	32-bit Peripheral Component Interconnect Express (PCIe) Card with 26 pin connector
Antenna	Dual Band for diversity and 2 x 2 MIMO support
Chip Set	Broadcom BCM4322
Input Power Requirements	3.3 VDC +/- 10%
Current Consumption (At maximum transmit power setting)	Transmit: 600 mA (1980 mW) Receive: 450 mA (1485 mW) Standby: TBD mA (TBD mW)
Operating Temperature	-30° to 75°C (-22° to 167°F)
Operating Humidity	10 to 90% (non-condensing)
Storage Temperature	-40° to 80°C (-40° to 176°F)
Storage Humidity	10 to 90% (non-condensing)

Feature	Description
Maximum Electrostatic Discharge	4 kV
Length	99.35 mm (3.91 in.)
Width	33.57 mm (1.32 in.)
Thickness	4.75 mm 0.18 in.)
Weight	15 g (0.53 oz.)
Mounting	26-pin connector and standard Express Card rails
Wireless Media	Direct Sequence-Spread Spectrum (DSSS) Orthogonal Frequency Divisional Multiplexing (OFDM)
Media Access Protocol	Carrier sense multiple access with collision avoidance (CSMA/CA)
Network Architecture Types	Infrastructure and ad hoc
Network Standards	IEEE 802.11a, 802.11b, 802.11d, 802.11e, 802.11g, 802.11h, 802.11i, 802.11n
Data Rates Supported	802.11a (OFDM): 6, 9, 12, 18, 24, 36, 48, 54 802.11b (DSSS): 1, 2, 5.5, 11 802.11g (OFDM): 6, 9, 12, 18, 24, 36, 48, 54 802.11n (OFDM, 20-MHz channels): 14, 29, 43, 58, 87, 116, 130, 144 802.11n (OFDM 40-MHz channels): 30, 60, 90, 120, 180, 240, 270, 300
Modulation	BPSK @ 1, 6, 9, 14, 30 Mbps QPSK @ 2, 12, 18, 29, 43, 60, 90 Mbps CCK @ 5.5, 11 Mbps 16-QAM @ 24, 36, 58, 87, 120, 180 Mbps 64-QAM @ 48, 54, 116, 130, 144, 240, 270, 300 Mbps
Modulation and Coding Scheme (MCS) Index Values Supported	0–15
Regulatory Domain Support	FCC (Americas, Parts of Asia and Middle East) ETSI (Europe, Middle East, Africa and Parts of Asia) MIC (formerly TELEC) (Japan) KCC (Korea)
2.4 GHz Frequency Bands	<b>ETSI</b> 2.4 GHz to 2.483 GHz <b>FCC</b> 2.4 GHz to 2.473 GHz <b>MIC (formerly TELEC)</b> 2.4 GHz to 2.495 GHz <b>KCC</b>



Feature	Description
	2.4 GHz to 2.483 GHz
5 GHz Frequency Bands	<b>ETSI</b> 5.15 GHz to 5.35 GHz 5.47 GHz to 5.725 GHz <b>FCC</b> 5.15 GHz to 5.35 GHz 5.47 GHz to 5.725 GHz 5.725 GHz to 5.82 GHz <b>MIC (formerly TELEC)</b> 5.15 GHz to 5.35 GHz <b>KCC</b> 5.15 GHz to 5.35 GHz 5.725 GHz to 5.82 GHz
2.4 GHz, 20 MHz-wide Operating Channels	ETSI: 13 (3 non-overlapping) FCC: 11 (3 non-overlapping) MIC: 14 (4 non-overlapping) KCC: 13 (3 non-overlapping)
5 GHz, 20 MHz-wide Operating Channels	ETSI: 19 non-overlapping FCC: 23 non-overlapping MIC: 8 non-overlapping KCC: 12 non-overlapping
5 GHz, 40 MHz-wide Operating Channels	ETSI: 9 non-overlapping FCC: 11 non-overlapping MIC: 4 non-overlapping
Transmit Power Settings	<b>802.11a:</b> 14 dBm (25 mW) <b>802.11b:</b> 17 dBm (50 mW) <b>802.11g:</b> 17 dBm (50 mW) <b>802.11n (20 MHz wide 2.4 GHz channel operation):</b> 17 dBm (50 mW) <b>802.11n (40 MHz wide 2.4 GHz channel operation):</b> 14 dBm (25 mW) <b>802.11n (20 MHz wide 5 GHz channel operation):</b> 15 dBm (30 mW) <b>802.11n (40 MHz wide 5 GHz channel operation):</b> 14 dBm (25 mW)

*Note: Maximum transmit power varies according to individual country regulations. All values nominal, +/-2 dBm*



Feature	Description
Typical Receiver Sensitivity  Note: We cannot currently test Typical Receiver Sensitivity for 802.11n due to lack of availability of an applicable AP (one that functions in Greenfield mode). We will have these numbers as soon as possible.	<b>802.11a</b>
	6 Mbps -85 dBm
	12 Mbps -83 dBm
	18 Mbps -80 dBm
	24 Mbps -76 dBm
	36 Mbps -73 dBm
	48 Mbps -70 dBm
	54 Mbps -65 dBm (PER <= 10%)
	<b>802.11b</b>
	1 Mbps -96 dBm
	2 Mbps -95 dBm
	5.5 Mbps -94 dBm
	11 Mbps -90 dBm (PER <= 10%)
	<b>802.11g</b>
	6 Mbps -94 dBm
	12 Mbps -88 dBm
	18 Mbps -86 dBm
	24 Mbps -83 dBm
	36 Mbps -78 dBm
	48 Mbps -76 dBm
	54 Mbps -75 dBm (PER <= 10%)
	<b>802.11n (20 MHz channels)</b>
	13 Mbps TBD dBm
	26 Mbps TBD dBm
	39 Mbps TBD dBm
	52 Mbps TBD dBm
	78 Mbps TBD dBm
104 Mbps TBD dBm	
117 Mbps TBD dBm	
130 Mbps TBD dBm (PER <= 10%)	
<b>802.11n (40 MHz channels)</b>	
27 Mbps TBD dBm	
54 Mbps TBD dBm	
81 Mbps TBD dBm	
108 Mbps TBD dBm	
162 Mbps TBD dBm	
216 Mbps TBD dBm	
243 Mbps TBD dBm	
270 Mbps TBD dBm (PER <= 10%)	

Feature	Description
Delay Spread	600 ns @ 1 Mbps 500 ns @ 2 Mbps 400 ns @ 5.5 Mbps 400 ns @ 6 Mbps 400 ns @ 9 Mbps 200 ns @ 11 Mbps 350 ns @ 12 Mbps 350 ns @ 18 Mbps 250 ns @ 24 Mbps 250 ns @ 36 Mbps 150 ns @ 48 Mbps 150 ns @ 54 Mbps
Security	<p><b>Standards</b></p> <ul style="list-style-type: none"> <li>Wireless Equivalent Privacy (WEP)</li> <li>Wi-Fi Protected Access (WPA)</li> <li>IEEE 802.11i (WPA2)</li> </ul> <p><b>Encryption</b></p> <ul style="list-style-type: none"> <li>Wireless Equivalent Privacy (WEP, RC4 Algorithm)</li> <li>Temporal Key Integrity Protocol (TKIP, RC4 Algorithm)</li> <li>Advanced Encryption Standard (AES, Rijndael Algorithm)</li> </ul> <p><b>Encryption Key Provisioning</b></p> <ul style="list-style-type: none"> <li>Static (40-bit and 128-bit lengths)</li> <li>Pre-Shared (PSK)</li> <li>Dynamic</li> </ul> <p><b>802.1X Extensible Authentication Protocol Types</b></p> <ul style="list-style-type: none"> <li>EAP-FAST</li> <li>EAP-TLS</li> <li>EAP-TTLS</li> <li>PEAP-TLS</li> <li>PEAP-GTC</li> <li>PEAP-MSCHAPv2</li> <li>LEAP</li> </ul>
Operating Systems Supported	Windows XP Professional and Embedded
Compliance	<p><b>ETSI Regulatory Domain</b></p> <p><a href="#">EN 300 328</a>  <a href="#">EN 301 489-1</a>  <a href="#">EN 301 489-17</a>  <a href="#">EN 301 893</a>  <a href="#">EN 60950-1</a>  <a href="#">EU 2011/65/EU (RoHS)</a></p> <p><b>FCC Regulatory Domain</b></p> <p><a href="#">Part 15.247 Subpart C</a>  <a href="#">Part 15.407 Subpart E</a></p> <p><b>Industry Canada</b></p>

Feature	Description
	<a href="#">RSS-210</a> <a href="#">RSS-Gen Issue 2</a> <b>MIC Regulatory Domain</b> <a href="#">Article 2 Item 19, Category WW (2.4GHz Channels 1-13)</a> <a href="#">Article 2 Item 19-2, Category GZ (2.4GHz Channel 14)</a> <a href="#">Article 2 Item 19-3 Category XW (5150-5250 W52 &amp; 5250-5350 W53)</a>
Certifications	<a href="#">Wi-Fi Alliance</a> 802.11a, 802.11b, 802.11g, 802.11n WPA Enterprise WPA2 Enterprise <a href="#">Cisco Compatible Extensions</a>  
Warranty	Limited Lifetime

*All specifications are subject to change without notice*

## PIN DEFINITIONS

**Note:** The following are industry-standard express card pinouts for reference only.

Pin Number	Pin Name	I/O	Power Supply	Description	Note
1	GND			Ground	
2	No Connect			Not Used. Leave Open (Float)	
3	No Connect			Not Used. Leave Open (Float)	
4	No Connect			Not Used. Leave Open (Float)	
5	No Connect			Not Used. Leave Open (Float)	
6	No Connect			Not Used. Leave Open (Float)	
7	No Connect			Not Used. Leave Open (Float)	
8	No Connect			Not Used. Leave Open (Float)	
9	VCC1_5			Primary 1.5 V Module Power	
10	VCC1_5			Primary 1.5 V Module Power	
11	WL_GPIO_1			Wake on Wireless LAN	
12	VAUX_3_3			Auxiliary 3.3 V Module Power	
13	PERST_L			Module Reset	
14	VCC3_3			Primary 3.3 V Module Power	
15	VCC3_3			Primary 3.3 V Module Power	
16	CLKREQ_L			Reference clock request signal	
17	No Connect			Not Used. Leave Open (Float)	
18	REFCLK_N			Differential reference clock	

## SDC-EC25N

### Hardware Integration Guide

Pin Number	Pin Name	I/O	Power Supply	Description	Note
19	REFCLK_P			Differential reference clock	
20	GND			Ground	
21	PERn0			Differential transmit	
22	PERp0			Differential transmit	
23	GND			Ground	
24	PETn0			Differential receive	
25	PETp0			Differential receive	
26	GND			Ground	

## MECHANICAL SPECIFICATIONS

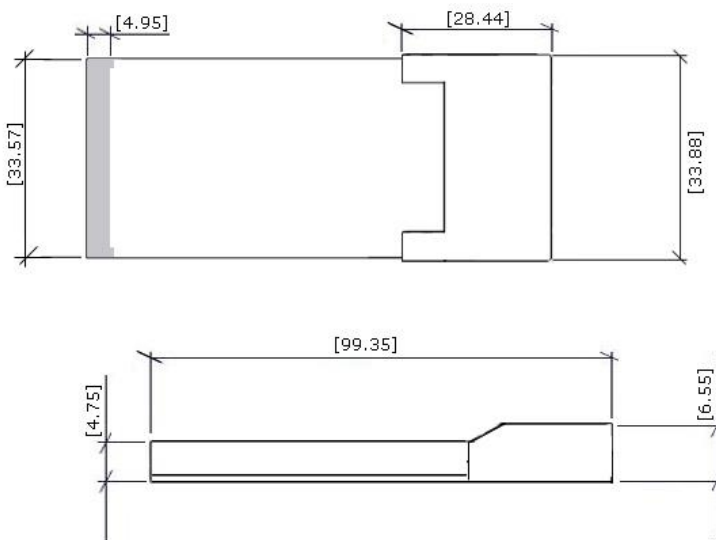

The SDC-EC25N is fully compliant with the PCI Express Card Type 1 mechanical standard. It can therefore be inserted in any Express Card hardware interface and typically does not require any additional mounting hardware.

## REGULATORY

**Note:** Operation in the 5150-5250 MHz band is limited to indoor use only in some regulatory domains.

### Antenna Characteristics

The SDC-EC25N incorporates an integrated dual band antenna consisting of two separate antenna elements to support transmit and receive diversity and 2 x 2 MIMO. The patterns for two separate antenna elements are below:

Type: Dipole

Maximum 2.4 GHz Gain: 0 dBi

Maximum 5 GHz Gain: 0 dBi

### Antenna 1 Patterns

XYZ @ 2400 MHz -2500 MHz

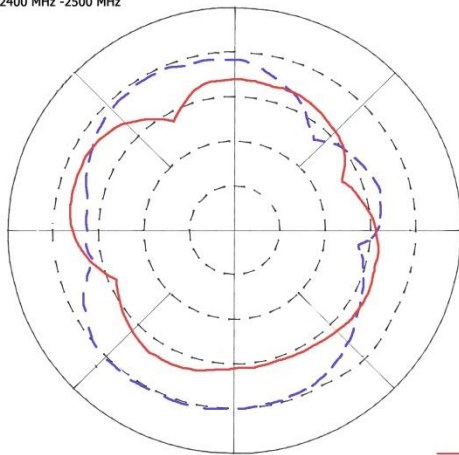

XYZ @ 5.18GHz

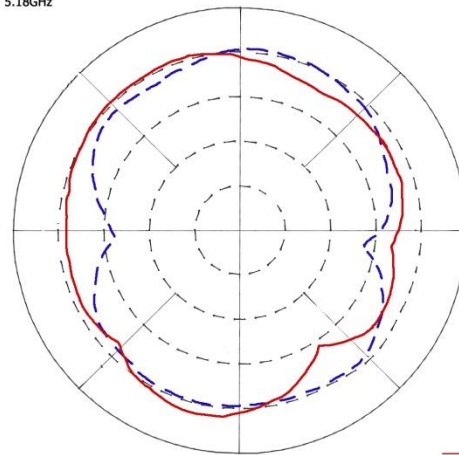

XYZ @ 5.81GHz

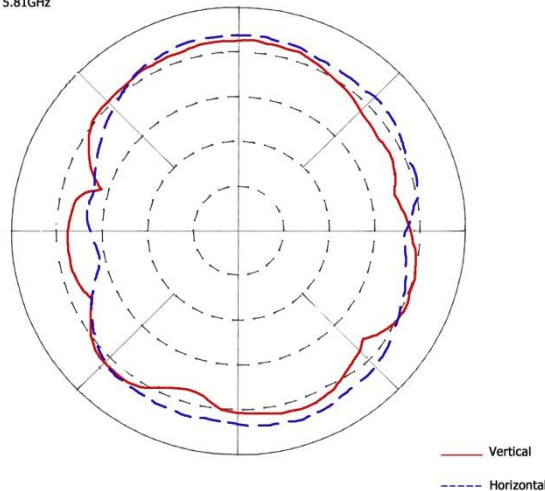

## Antenna 2 Patterns

XYZ @ 2400 MHz -2500 MHz

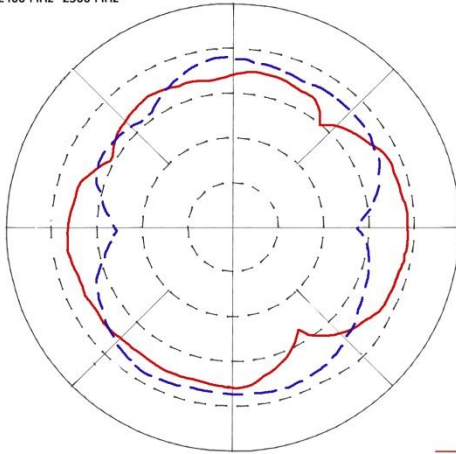

XYZ @ 5.18GHz

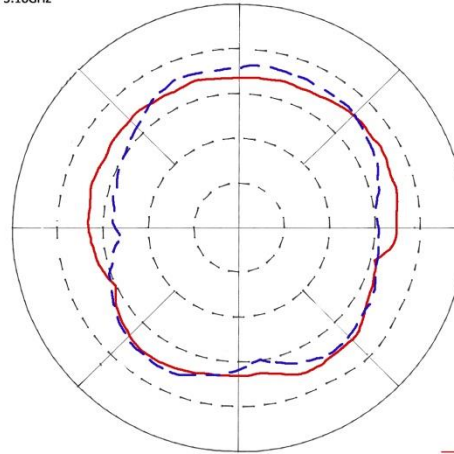

— Vertical  
- - - Horizontal

— Vertical  
- - - Horizontal

XYZ @ 5.81GHz

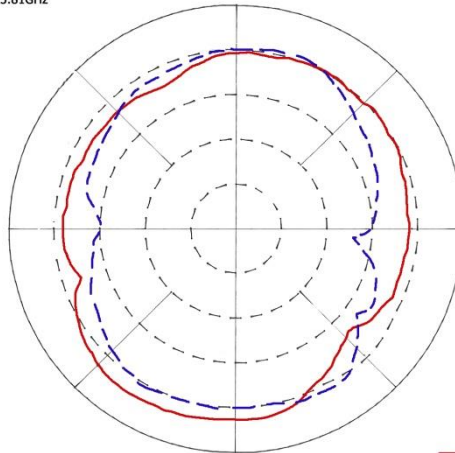

— Vertical  
- - - Horizontal

## Documentation Requirements

In order to maintain regulatory compliance, when integrating the SDC-EC25N into a host device and leveraging Summit's grants and certifications, it is necessary to meet the documentation requirements set forth by the applicable regulatory agencies. The following sections (FCC, Industry Canada, and European Union) outline the information that may be included in the user's guide and external labels for the host devices into which the SDC-EC25N is integrated.

SDC-EC25N approvals are based on the SDC-PE15N.

### FCC

#### *User's Guide Requirements*

As outlined in the Operational Description, the SDC-EC25N complies with [FCC Part 15 Rules](#) for a Modular Approval. To leverage Summit's grant, the two conditions below must be met for the host device into which the SDC-EC25N is integrated:

1. The antenna is installed with 20 cm maintained between the antenna and users.

2. The transmitter module is not co-located with any other transmitter or antenna that is capable of simultaneous operation.

As long as the two conditions above are met, further *transmitter* testing is typically not required. However, the OEM integrator is still responsible for testing its end-product for any additional compliance requirements required with this module installed, such as (but not limited to) digital device emissions and PC peripheral requirements.

#### **IMPORTANT!**

---

In the event that the two conditions above ***cannot be met*** (for example certain device configurations or co-location with another transmitter), then the FCC authorization is no longer considered valid and the FCC ID ***cannot*** be used on the final product. In these circumstances, the OEM integrator will be responsible for re-evaluating the end product (including the transmitter) and obtaining a separate FCC authorization.

---

When using Summit's FCC grant for the SDC-EC25N, the integrator must include specific information in the user's guide for the device into which the SDC-EC25N is integrated. The integrator must not provide information to the end user regarding how to install or remove this RF module in the user's manual of the device into which the SDC-EC25N is integrated. The following FCC statements must be added in their entirety and without modification into a prominent place in the user's guide for the device into which the SDC-EC25N is integrated:

---

**"IMPORTANT NOTE:** To comply with FCC RF exposure compliance requirements, the antenna used for this transmitter must be installed to provide a separation distance of at least 20 cm from all persons and must not be co-located or operating in conjunction with any other antenna or transmitter."

---

#### **Federal Communication Commission Interference Statement**

This equipment has been tested and found to comply with the limits for a Class B digital device, pursuant to Part 15 of the FCC Rules. These limits are designed to provide reasonable protection against harmful interference in a residential installation. This equipment generates, uses, and can radiate radio frequency energy and, if not installed and used in accordance with the instructions, may cause harmful interference to radio communications. However, there is no guarantee that interference will not occur in a particular installation. If this equipment does cause harmful interference to radio or television reception, which can be determined by turning the equipment off and on, the user is encouraged to try to correct the interference by one of the following measures:

1. Reorient or relocate the receiving antenna.
2. Increase the separation between the equipment and receiver.
3. Connect the equipment into an outlet on a circuit different from that to which the receiver is connected.
4. Consult the dealer or an experienced radio/TV technician for help.

---

**FCC Caution:** Any changes or modifications not expressly approved by the party responsible for compliance could void the user's authority to operate this equipment.

---

This device complies with Part 15 of the FCC Rules. Operation is subject to the following two conditions: (1) This device may not cause harmful interference, and (2) this device must accept any interference received, including interference that may cause undesired operation.

---

**IMPORTANT NOTE:** FCC Radiation Exposure Statement:

This equipment complies with FCC radiation exposure limits set forth for an uncontrolled environment. This equipment should be installed and operated with minimum distance 20cm between the radiator & your body.

---

## Industry Canada

### *User's Guide Requirements*

As outlined in the Operational Description, the SDC-EC25N complies with Industry Canada (IC) rules for a Limited Modular Approval. To leverage Summit's grant, the two conditions below must be met for the host device into which the SDC-EC25N is integrated:

1. The antenna is installed with 20 cm maintained between the antenna and users.
2. The transmitter module is not co-located with any other transmitter or antenna that is capable of simultaneous operation.

As long as the two conditions above are met, further *transmitter* testing is typically not required. However, the OEM integrator is still responsible for testing its end-product for any additional compliance requirements required with this module installed, such as (but not limited to) digital device emissions and PC peripheral requirements.

### **IMPORTANT!**

---

In the event that the two conditions above ***cannot be met*** (for example certain device configurations or co-location with another transmitter), then the IC authorization is no longer considered valid and the IC ID ***cannot*** be used on the final product. In these circumstances, the OEM integrator will be responsible for re-evaluating the end product (including the transmitter) and obtaining a separate IC authorization.

---

When using Summit's IC grant for the SDC-EC25N, the integrator must include specific information in the user's guide for the device into which the SDC-EC25N is integrated. The integrator must not provide information to the end user regarding how to install or remove this RF module in the user's manual of the device into which the SDC-EC25N is integrated. In addition to the required FCC statements outlined above, the following IC statements must be added in their entirety and without modification into a prominent place in the user's guide for the device into which the SDC-EC25N is integrated:

To prevent radio interference to the licensed service, this device is intended to be operated indoors and away from windows to provide maximum shielding. Equipment (or its transmit antenna) that is installed outdoors is subject to licensing.

## European Union

### *User's Guide Requirements*

The integrator must include specific information in the user's guide for the device into which the SDC-EC25N is integrated. In addition to the required FCC and IC statements outlined above, the following R&TTE statements must be added in their entirety and without modification into a prominent place in the user's guide for the device into which the SDC-EC25N is integrated:

This device complies with the essential requirements of the R&TTE Directive 1999/5/EC. The following test methods have been applied in order to prove presumption of conformity with the essential requirements of the R&TTE Directive 1999/5/EC:

- EN60950-1:2001 A11:2004  
Safety of Information Technology Equipment
- EN 300 328 V1.7.1: (2006-10)









Electromagnetic compatibility and Radio spectrum Matters (ERM); Wideband Transmission systems; Data transmission equipment operating in the 2,4 GHz ISM band and using spread spectrum modulation techniques; Harmonized EN covering essential requirements under article 3.2 of the R&TTE Directive











- **EN 301 489-1 V1.6.1: (2005-09)**  
Electromagnetic compatibility and Radio Spectrum Matters (ERM); ElectroMagnetic Compatibility (EMC) standard for radio equipment and services; Part 1: Common technical requirements
- **EN 301 489-17 V1.2.1 (2002-08)**  
Electromagnetic compatibility and Radio spectrum Matters (ERM); ElectroMagnetic Compatibility (EMC) standard for radio equipment and services; Part 17: Specific conditions for 2,4 GHz wideband transmission systems and 5 GHz high performance RLAN equipment
- **EN 301 893 V1.5.1 (2008-12)**  
Electromagnetic compatibility and Radio spectrum Matters (ERM); Broadband Radio Access Networks (BRAN); Specific conditions for 5 GHz high performance RLAN equipment
- **EU 2002/95/EC (RoHS)**  
Declaration of Compliance – EU Directive 2003/95/EC; Reduction of Hazardous Substances (RoHS)

This device is a 2.4 GHz wideband transmission system (transceiver), intended for use in all EU member states and EFTA countries, except in France and Italy where restrictive use applies.

In Italy the end-user should apply for a license at the national spectrum authorities in order to obtain authorization to use the device for setting up outdoor radio links and/or for supplying public access to telecommunications and/or network services.

This device may not be used for setting up outdoor radio links in France and in some areas the RF output power may be limited to 10 mW EIRP in the frequency range of 2454 – 2483.5 MHz. For detailed information the end-user should contact the national spectrum authority in France.

 <b>Česky</b> [Czech]	<i>[Jméno výrobce]</i> tímto prohlašuje, že tento <i>[typ zařízení]</i> je ve shodě se základními požadavky a dalšími příslušnými ustanoveními směrnice 1999/5/ES.
 <b>Dansk</b> [Danish]	Undertegnede <i>[fabrikantens navn]</i> erklærer herved, at følgende udstyr <i>[udstyrets typebetegnelse]</i> overholder de væsentlige krav og øvrige relevante krav i direktiv 1999/5/EF.
 <b>Deutsch</b> [German]	Hiermit erkläre <i>[Name des Herstellers]</i> , dass sich das Gerät <i>[Gerätetyp]</i> in Übereinstimmung mit den grundlegenden Anforderungen und den übrigen einschlägigen Bestimmungen der Richtlinie 1999/5/EG befindet.
 <b>Eesti</b> [Estonian]	Käesolevaga kinnitab <i>[tootja nimi = name of manufacturer]</i> seadme <i>[seadme tüüp = type of equipment]</i> vastavust direktiivi 1999/5/EÜ põhinõuetele ja nimetatud direktiivist tulenevatele teistele asjakohastele sätetele.
 <b>English</b>	Hereby, <i>[name of manufacturer]</i> , declares that this <i>[type of equipment]</i> is in compliance with the essential requirements and other relevant provisions of Directive 1999/5/EC.
 <b>Español</b> [Spanish]	Por medio de la presente <i>[nombre del fabricante]</i> declara que el <i>[clase de equipo]</i> cumple con los requisitos esenciales y cualesquiera otras disposiciones aplicables o exigibles de la Directiva 1999/5/CE.

 Ελληνική [Greek]	ΜΕ ΤΗΝ ΠΑΡΟΥΣΑ [ <i>name of manufacturer</i> ] ΔΗΛΩΝΕΙ ΟΤΙ [ <i>type of equipment</i> ] ΣΥΜΜΟΡΦΩΝΕΤΑΙ ΠΡΟΣ ΤΙΣ ΟΥΣΙΩΔΕΙΣ ΑΠΑΙΤΗΣΕΙΣ ΚΑΙ ΤΙΣ ΛΟΙΠΕΣ ΣΧΕΤΙΚΕΣ ΔΙΑΤΑΞΕΙΣ ΤΗΣ ΟΔΗΓΙΑΣ 1999/5/ΕΚ.
 Français [French]	Par la présente [ <i>nom du fabricant</i> ] déclare que l'appareil [ <i>type d'appareil</i> ] est conforme aux exigences essentielles et aux autres dispositions pertinentes de la directive 1999/5/CE.
 Italiano [Italian]	Con la presente [ <i>nome del costruttore</i> ] dichiara che questo [ <i>tipo di apparecchio</i> ] è conforme ai requisiti essenziali ed alle altre disposizioni pertinenti stabilite dalla direttiva 1999/5/CE.
Latviski [Latvian]	Ar šo [ <i>name of manufacturer / izgatavotāja nosaukums</i> ] deklarē, ka [ <i>type of equipment / iekārtas tips</i> ] atbilst Direktīvas 1999/5/EK būtiskajām prasībām un citiem ar to saistītajiem noteikumiem.
Lietuvių [Lithuanian]	Šiuo [ <i>manufacturer name</i> ] deklaruoją, kad šis [ <i>equipment type</i> ] atitinka esminius reikalavimus ir kitas 1999/5/EB Direktyvos nuostatas.
 Nederlands [Dutch]	Hierbij verklaart [ <i>naam van de fabrikant</i> ] dat het toestel [ <i>type van toestel</i> ] in overeenstemming is met de essentiële eisen en de andere relevante bepalingen van richtlijn 1999/5/EG.
 Malti [Maltese]	Hawnhekk, [ <i>isem tal-manifattur</i> ], jiddikjara li dan [ <i>il-mudel tal-prodott</i> ] jikkonforma mal-ħtiġijiet essenzjali u ma provvedimenti oħrajn rilevanti li hemm fid-Dirrettiva 1999/5/EC.
 Magyar [Hungarian]	Alulírott, [ <i>gyártó neve</i> ] nyilatkozom, hogy a [ <i>... típus</i> ] megfelel a vonatkozó alapvető követelményeknek és az 1999/5/EC irányelv egyéb előírásainak.
 Polski [Polish]	Niniejszym [ <i>nazwa producenta</i> ] oświadczam, że [ <i>nazwa wyrobu</i> ] jest zgodny z zasadniczymi wymogami oraz pozostałymi stosownymi postanowieniami Dyrektywy 1999/5/EC.
 Português [Portuguese]	[ <i>Nome do fabricante</i> ] declara que este [ <i>tipo de equipamento</i> ] está conforme com os requisitos essenciais e outras disposições da Directiva 1999/5/CE.
 Slovensko [Slovenian]	[ <i>Ime proizvajalca</i> ] izjavlja, da je ta [ <i>tip opreme</i> ] v skladu z bistvenimi zahtevami in ostalimi relevantnimi določili direktive 1999/5/ES.
Slovensky [Slovak]	[ <i>Meno výrobcu</i> ] týmto vyhlasuje, že [ <i>typ zariadenia</i> ] spĺňa základné požiadavky a všetky príslušné ustanovenia Smernice 1999/5/ES.
 Suomi [Finnish]	[ <i>Valmistaja = manufacturer</i> ] vakuuttaa täten että [ <i>type of equipment = laitteen tyyppimerkintä</i> ] tyypinen laite on direktiivin 1999/5/EY oleellisten vaatimusten ja sitä koskevien direktiivin muiden ehtojen mukainen.
 Svenska [Swedish]	Härmed intygar [ <i>företag</i> ] att denna [ <i>utrustningstyp</i> ] står i överensstämmelse med de väsentliga egenskapskrav och övriga relevanta bestämmelser som framgår av direktiv 1999/5/EG.