



Chipsmall Limited consists of a professional team with an average of over 10 year of expertise in the distribution of electronic components. Based in Hongkong, we have already established firm and mutual-benefit business relationships with customers from,Europe,America and south Asia,supplying obsolete and hard-to-find components to meet their specific needs.

With the principle of "Quality Parts,Customers Priority,Honest Operation,and Considerate Service",our business mainly focus on the distribution of electronic components. Line cards we deal with include Microchip,ALPS,ROHM,Xilinx,Pulse,ON,Everlight and Freescale. Main products comprise IC,Modules,Potentiometer,IC Socket,Relay,Connector.Our parts cover such applications as commercial,industrial, and automotives areas.

We are looking forward to setting up business relationship with you and hope to provide you with the best service and solution. Let us make a better world for our industry!



Contact us

Tel: +86-755-8981 8866 Fax: +86-755-8427 6832

Email & Skype: info@chipsmall.com Web: www.chipsmall.com

Address: A1208, Overseas Decoration Building, #122 Zhenhua RD., Futian, Shenzhen, China



SDP8406

Silicon Phototransistor

FEATURES

- Side-looking plastic package
- 50° (nominal) acceptance angle
- Wide sensitivity ranges
- Mechanically and spectrally matched to SEP8506 and SEP8706 infrared emitting diodes

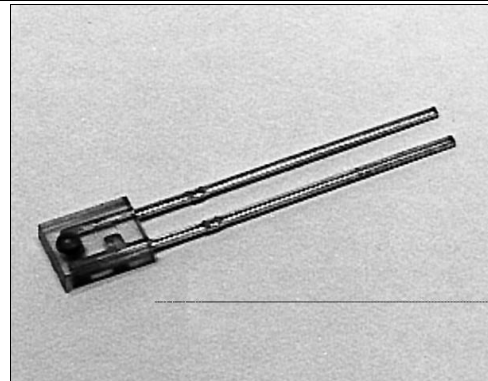

INFRA-21.TIF

DESCRIPTION

The SDP8406 is an NPN silicon phototransistor molded in a side-looking clear plastic package. The chip is positioned to accept radiation through a plastic lens from the side of the package.

OUTLINE DIMENSIONS in inches (mm)

Tolerance 3 plc decimals ±0.005(0.12)
2 plc decimals ±0.020(0.51)

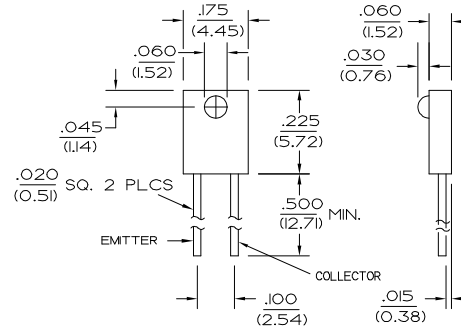

DIM_017.d64

SDP8406

Silicon Phototransistor

ELECTRICAL CHARACTERISTICS (25°C unless otherwise noted)

PARAMETER	SYMBOL	MIN	TYP	MAX	UNITS	TEST CONDITIONS
Light Current	I_L				mA	$V_{CE}=5\text{ V}$ $H=1\text{ mW/cm}^2$ (1)
SDP8406-001		0.15		1.90		
SDP8406-002		1.80		3.60		
SDP8406-003		3.40		6.50		
SDP8406-004		6.40		12.0		
Collector Dark Current	I_{CEO}			100	nA	$V_{CE}=15\text{ V}$, $H=0$
Collector-Emitter Breakdown Voltage	$V_{(BR)CEO}$	30			V	$I_C=100\text{ }\mu\text{A}$
Emitter-Collector Breakdown Voltage	$V_{(BR)ECO}$	5.0			V	$I_E=100\text{ }\mu\text{A}$
Collector-Emitter Saturation Voltage	$V_{CE(SAT)}$			0.4	V	$I_C=I_L/8$ $H=1\text{ mW/cm}^2$
Angular Response (2)	\varnothing		50		degr.	$I_F=\text{Constant}$
Rise And Fall Time	t_r, t_f		15		μs	$V_{CC}=5\text{ V}$, $I_L=1\text{ mA}$ $R_L=1000\text{ }\Omega$

Notes

1. The radiation source is an IRED with a peak wavelength of 935 nm.
2. Angular response is defined as the total included angle between the half sensitivity points.

ABSOLUTE MAXIMUM RATINGS

(25°C Free-Air Temperature unless otherwise noted)

Collector-Emitter Voltage	30 V
Emitter-Collector Voltage	5 V
Power Dissipation	100 mW (1)
Operating Temperature Range	-40°C to 85°C
Storage Temperature Range	-40°C to 85°C
Soldering Temperature (5 sec)	240°C

Notes

1. Derate linearly from 25°C free-air temperature at the rate of 0.78 mW/°C.

SCHEMATIC

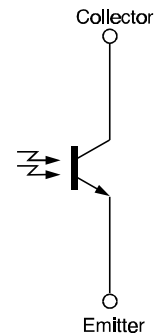

Honeywell reserves the right to make changes in order to improve design and supply the best products possible.

Honeywell

SDP8406

Silicon Phototransistor

SWITCHING TIME TEST CIRCUIT

cir_015.cdr

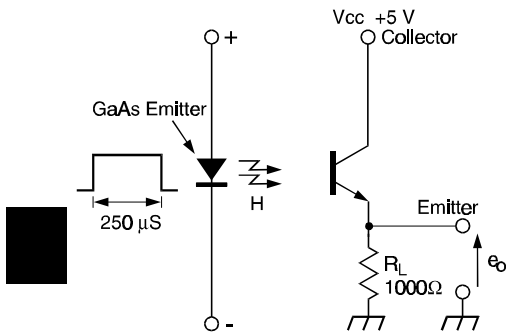

Fig. 1 Responsivity vs Angular Displacement

gra_054.ds4

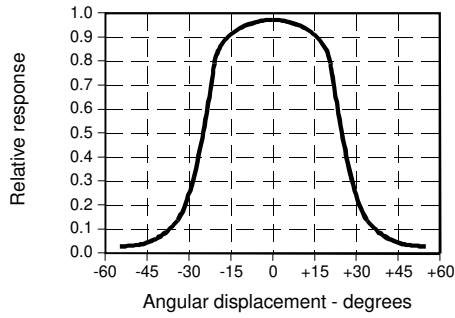
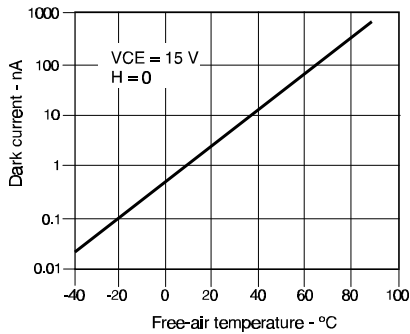

Fig. 3 Dark Current vs Temperature

gra_301.cdr



SWITCHING WAVEFORM

cir_004.cdr

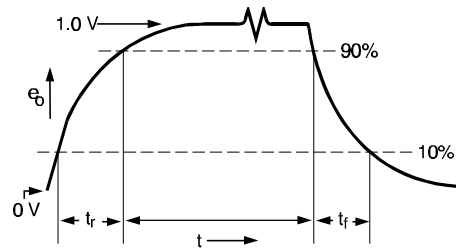

Fig. 2 Collector Current vs Ambient Temperature

gra_039.ds4

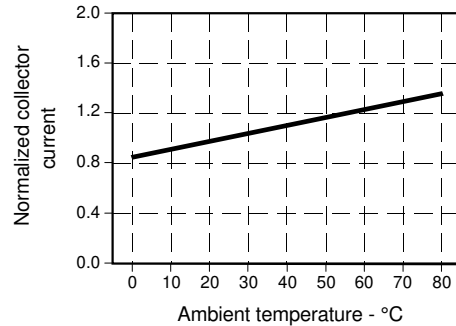
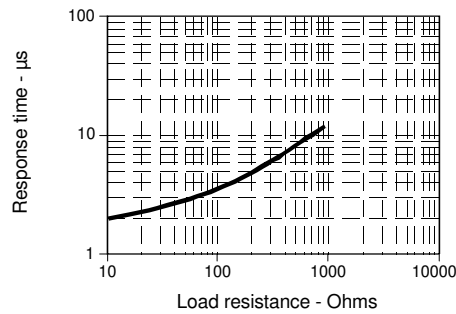

Fig. 4 Non-Saturated Switching Time vs Load Resistance

gra_041.ds4



SDP8406

Silicon Phototransistor

Fig. 5 Spectral Responsivity

gra_036.ds4

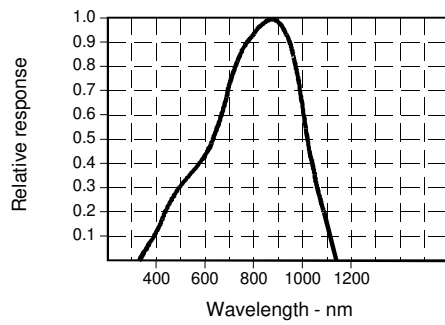
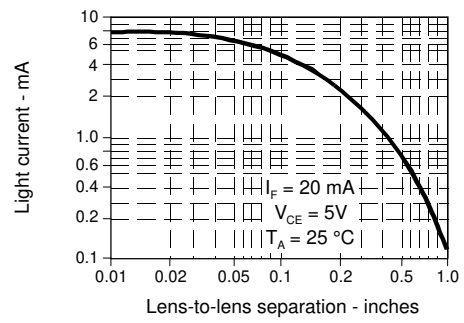

Fig. 6 Coupling Characteristics with SEP8506

gra_031.ds4



All Performance Curves Show Typical Values