



Chipsmall Limited consists of a professional team with an average of over 10 year of expertise in the distribution of electronic components. Based in Hongkong, we have already established firm and mutual-benefit business relationships with customers from,Europe,America and south Asia,supplying obsolete and hard-to-find components to meet their specific needs.

With the principle of "Quality Parts,Customers Priority,Honest Operation,and Considerate Service",our business mainly focus on the distribution of electronic components. Line cards we deal with include Microchip,ALPS,ROHM,Xilinx,Pulse,ON,Everlight and Freescale. Main products comprise IC,Modules,Potentiometer,IC Socket,Relay,Connector.Our parts cover such applications as commercial,industrial, and automotives areas.

We are looking forward to setting up business relationship with you and hope to provide you with the best service and solution. Let us make a better world for our industry!



## Contact us

Tel: +86-755-8981 8866 Fax: +86-755-8427 6832

Email & Skype: info@chipsmall.com Web: www.chipsmall.com

Address: A1208, Overseas Decoration Building, #122 Zhenhua RD., Futian, Shenzhen, China



# SDP8436

## Silicon Phototransistor

### FEATURES

- Side-looking plastic package
- 18° (nominal) acceptance angle
- Enhanced coupling distance
- Internal visible light rejection filter
- Low profile for design flexibility
- Wide sensitivity ranges
- Mechanically matched to SEP8736 infrared emitting diode



INFRA-82.TIF

### DESCRIPTION

The SDP8436 is an NPN silicon phototransistor molded in a black plastic package which combines the mounting advantages of a side-looking package with the narrow acceptance angle and high optical gain of a T-1 package. The SDP8436 is designed for those applications which require longer coupling distances than standard side-looking devices can provide, such as touch screens. The device is also well suited to applications in which adjacent channel crosstalk could be a problem. The package is highly transmissive to the IR source energy while it provides effective shielding against visible ambient light.

### OUTLINE DIMENSIONS in inches (mm)

Tolerance 3 plc decimals ±0.005(0.12)  
2 plc decimals ±0.020(0.51)

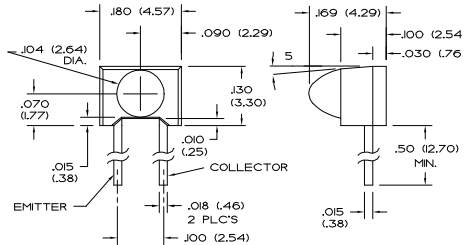

DIM\_019.dwg

# SDP8436

## Silicon Phototransistor

### ELECTRICAL CHARACTERISTICS (25°C unless otherwise noted)

PARAMETER	SYMBOL	MIN	TYP	MAX	UNITS	TEST CONDITIONS
Light Current	$I_L$				mA	$V_{CE}=5\text{ V}$ $H=1\text{ mW/cm}^2$ (1)
SDP8436-001		0.50				
SDP8436-002		4.00	10.0			
SDP8436-003		7.00	17.5			
SDP8436-004		12.5				
Collector Dark Current	$I_{CEO}$			100	nA	$V_{CE}=15\text{ V}$ , $H=0$
Collector-Emitter Breakdown Voltage	$V_{(BR)CEO}$	30			V	$I_C=100\text{ }\mu\text{A}$
Emitter-Collector Breakdown Voltage	$V_{(BR)ECO}$	5.0			V	$I_E=100\text{ }\mu\text{A}$
Collector-Emitter Saturation Voltage	$V_{CE(SAT)}$			0.4	V	$I_C=0.1\text{ mA}$ $H=1\text{ mW/cm}^2$
Angular Response (2)	$\varnothing$		18		degr.	$I_F=\text{Constant}$
Rise And Fall Time	$t_r, t_f$		15		$\mu\text{s}$	$V_{CC}=5\text{ V}$ , $I_L=1\text{ mA}$ $R_L=1000\text{ }\Omega$

#### Notes

- The radiation source is an IRED with a peak wavelength of 880 nm.
- Angular response is defined as the total included angle between the half sensitivity points.

### ABSOLUTE MAXIMUM RATINGS

(25°C Free-Air Temperature unless otherwise noted)

Collector-Emitter Voltage	30 V
Emitter-Collector Voltage	5 V
Power Dissipation	100 mW (1)
Operating Temperature Range	-40°C to 85°C
Storage Temperature Range	-40°C to 85°C
Soldering Temperature (5 sec)	240°C

#### Notes

- Derate linearly from 25°C free-air temperature at the rate of 0.78 mW/°C.

### SCHEMATIC

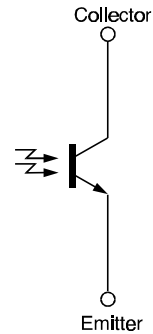

Honeywell reserves the right to make changes in order to improve design and supply the best products possible.

# Honeywell

# SDP8436

## Silicon Phototransistor

SWITCHING TIME TEST CIRCUIT

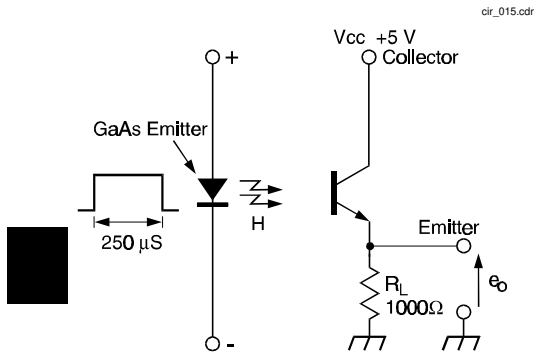

Fig. 1 Responsivity vs Angular Displacement

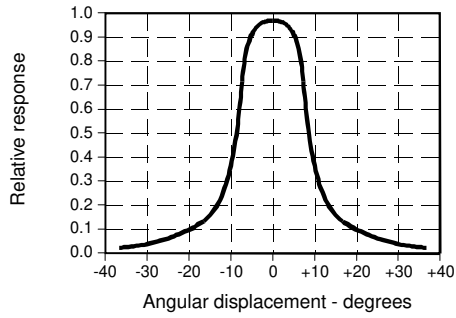
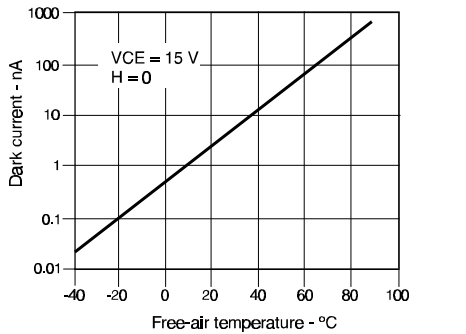

Fig. 3 Dark Current vs Temperature



SWITCHING WAVEFORM

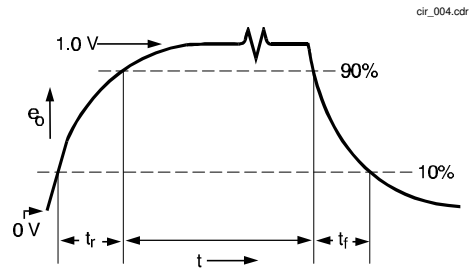

Fig. 2 Collector Current vs Ambient Temperature

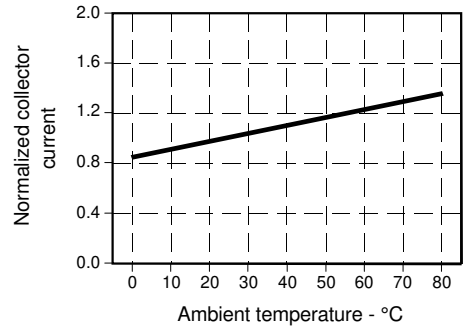
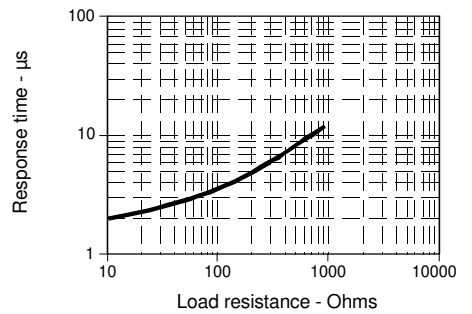

Fig. 4 Non-Saturated Switching Time vs Load Resistance



# SDP8436

Silicon Phototransistor

Fig. 5 Spectral Responsivity

gra\_050.ds4

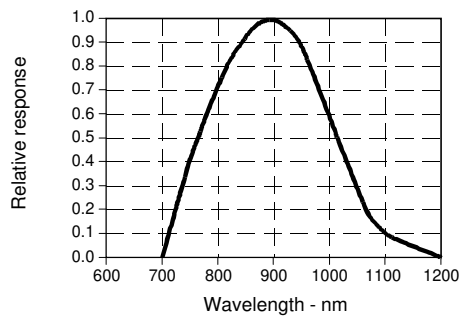
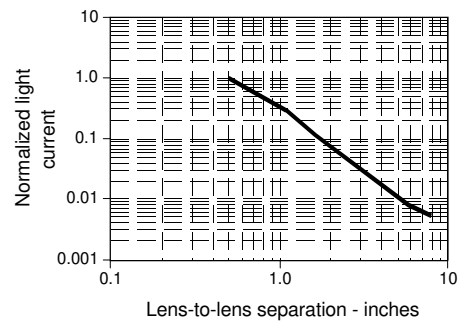

Fig. 6 Coupling Characteristics with SEP8736

gra\_034.ds4



All Performance Curves Show Typical Values