



Chipsmall Limited consists of a professional team with an average of over 10 year of expertise in the distribution of electronic components. Based in Hongkong, we have already established firm and mutual-benefit business relationships with customers from,Europe,America and south Asia,supplying obsolete and hard-to-find components to meet their specific needs.

With the principle of "Quality Parts,Customers Priority,Honest Operation,and Considerate Service",our business mainly focus on the distribution of electronic components. Line cards we deal with include Microchip,ALPS,ROHM,Xilinx,Pulse,ON,Everlight and Freescale. Main products comprise IC,Modules,Potentiometer,IC Socket,Relay,Connector.Our parts cover such applications as commercial,industrial, and automotives areas.

We are looking forward to setting up business relationship with you and hope to provide you with the best service and solution. Let us make a better world for our industry!



Contact us

Tel: +86-755-8981 8866 Fax: +86-755-8427 6832

Email & Skype: info@chipsmall.com Web: www.chipsmall.com

Address: A1208, Overseas Decoration Building, #122 Zhenhua RD., Futian, Shenzhen, China



Enable High Flux and Cost Efficient System

Z Power Chip on board – ZC series

SDW*5F1C (SDW05F1C, SDW85F1C, SDW95F1C)

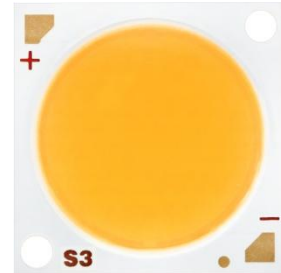

Product Brief

Description

- The ZC series are LED arrays which provide High Flux and High Efficacy.
- It is especially designed for easy assembly of lighting fixtures by eliminating reflow soldering process.
- It's thermal management is better than other power LED solutions with wide Metal area.
- ZC series are ideal light sources for General Lighting applications including Replacement Lamps, Industrial & Commercial Lightings and other high Lumen required applications.

Features and Benefits

- Size 28mm * 28mm
- Power dissipation 35.8 ~ 74W
- Wide CCT range with CRI70~90
- Forward V_F typ 35.8V
- Maximum Current 1.84A
- MacAdam 3-step binning
- Uniformed Shadow
- Excellent Thermal management
- RoHS compliant

Key Applications

- Commercial – Downlight
- Industrial – High/Low Bay lighting
- Residential
- Replacement lamps – Bulb, PAR
- Outdoor area – Street lighting, Tunnel lighting, Parking area lighting

Table 1. Product Selection Table

| Part Number | CCT [K] | | | |
|-------------|---------------|-------|------|-------|
| | Color | Min. | Typ. | Max. |
| SDW05F1C | Cool White | 4,700 | - | 6,000 |
| | Neutral White | 3,700 | - | 4,700 |
| SDW85F1C | Cool White | 4,700 | - | 6,000 |
| | Neutral White | 3,700 | - | 4,700 |
| | Warm White | 2,600 | - | 3,700 |
| SDW95F1C | Neutral White | 3,700 | - | 4,200 |
| | Warm White | 2,600 | - | 3,700 |

Table of Contents

| Index | | |
|--------------|--|----|
| • | Product Brief | 1 |
| • | Product Performance & Characterization Guide | 3 |
| • | Characteristics Graph | 6 |
| • | Product Nomenclature (Labeling Information) | 14 |
| • | Color Bin Structure | 15 |
| • | Mechanical Dimensions | 20 |
| • | Packaging Specification | 21 |
| • | Handling of Silicone Resin for LEDs | 23 |
| • | Precaution For Use | 24 |
| • | Company Information | 27 |

Product Performance & Characterization Guide

Table 2. Electro Optical Characteristics, $T_j=25^{\circ}\text{C}$

| Part Number | CCT (K) ^[1] | Typical Luminous Flux ^[2] , Φ_v ^[3] (lm) | | Typical Forward Voltage, V_F ^[4] (V) | | CRI ^[5] , R_a | Viewing Angle (degrees) $2\theta_{1/2}$ |
|-------------|------------------------|--|--------|--|--------|-------------------------------|---|
| | Typ. | 1A | 1.84A* | 1A | 1.84A* | Min. | Typ. |
| SDW05F1C | 5600 | 5200 | 8216 | 35.8 | 37.5 | 70 | 120 |
| | 5000 | 5300 | 8374 | 35.8 | 37.5 | 70 | 120 |
| | 4500 | 5200 | 8216 | 35.8 | 37.5 | 70 | 120 |
| | 4000 | 5180 | 8184 | 35.8 | 37.5 | 70 | 120 |
| SDW85F1C | 5600 | 4878 | 7512 | 35.8 | 37.5 | 80 | 120 |
| | 5000 | 4961 | 7639 | 35.8 | 37.5 | 80 | 120 |
| | 4000 | 4783 | 7356 | 35.8 | 37.5 | 80 | 120 |
| | 3500 | 4680 | 7198 | 35.8 | 37.5 | 80 | 120 |
| | 3000 | 4575 | 7036 | 35.8 | 37.5 | 80 | 120 |
| | 2700 | 4400 | 6767 | 35.8 | 37.5 | 80 | 120 |
| SDW95F1C | 4000 | 4100 | 5207 | 35.8 | 37.5 | 90 | 120 |
| | 3500 | 3876 | 4923 | 35.8 | 37.5 | 90 | 120 |
| | 3000 | 3800 | 4826 | 35.8 | 37.5 | 90 | 120 |
| | 2700 | 3700 | 4699 | 35.8 | 37.5 | 90 | 120 |

Notes :

- (1) Correlated Color Temperature is derived from the CIE 1931 Chromaticity diagram. Color coordinate : ± 0.01 , CCT $\pm 5\%$ tolerance.
- (2) Seoul Semiconductor maintains a tolerance of $\pm 7\%$ on flux and power measurements.
- (3) Φ_v is the total luminous flux output as measured with an integrating sphere.
- (4) Tolerance is $\pm 3\%$ on forward voltage measurements.
- (5) Tolerance is ± 2 on CRI measurements.

* No values are provided by real measurement. Only for reference purpose.

Product Performance & Characterization Guide

Table 3. Electro Optical Characteristics, $T_j=85^{\circ}\text{C}$

| Part Number | CCT (K) ^[1] | Typical Luminous Flux ^[2] , Φ_v ^[3] (lm) | Typical Forward Voltage, V_f ^[4] (V) |
|-------------|------------------------|--|--|
| | Typ. | 1A * | 1A * |
| SDW05F1C | 5600 | 4680 | 34.3 |
| | 5000 | 4770 | 34.3 |
| | 4500 | 4680 | 34.3 |
| | 4000 | 4662 | 34.3 |
| SDW85F1C | 5600 | 4341 | 34.3 |
| | 5000 | 4415 | 34.3 |
| | 4000 | 4257 | 34.3 |
| | 3500 | 4165 | 34.3 |
| | 3000 | 4072 | 34.3 |
| | 2700 | 3916 | 34.3 |
| SDW95F1C | 4000 | 3567 | 34.3 |
| | 3500 | 3372 | 34.3 |
| | 3000 | 3306 | 34.3 |
| | 2700 | 3219 | 34.3 |

Notes :

- (1) Correlated Color Temperature is derived from the CIE 1931 Chromaticity diagram. Color coordinate : ± 0.01 , CCT $\pm 5\%$ tolerance.
- (2) Seoul Semiconductor maintains a tolerance of $\pm 7\%$ on flux and power measurements.
- (3) Φ_v is the total luminous flux output as measured with an integrating sphere.
- (4) Tolerance is $\pm 3\%$ on forward voltage measurements.
- (5) Tolerance is ± 2 on CRI measurements.

* No values are provided by real measurement. Only for reference purpose.

Product Performance & Characterization Guide

Table 4. Absolute Maximum Characteristics, $T_j=25^{\circ}\text{C}$

| Parameter | Symbol | Value | | | Unit |
|--|-----------------|------------------------|------|------|--------------------|
| | | Min. | Typ. | Max. | |
| Forward Current | I_F | - | 1 | 1.84 | A |
| Power Dissipation | P_d | - | 35.8 | 74 | W |
| Junction Temperature | T_j | - | - | 140 | $^{\circ}\text{C}$ |
| Operating Temperature | T_{opr} | -40 | - | 85 | $^{\circ}\text{C}$ |
| Surface Temperature | T_s | - | - | 100 | $^{\circ}\text{C}$ |
| Storage Temperature | T_{stg} | -40 | - | 100 | $^{\circ}\text{C}$ |
| Thermal resistance (J to S) ^[1] | $R\theta_{J-S}$ | - | 0.48 | - | K/W |
| ESD Sensitivity(HBM) | - | Class 3A JESD22-A114-E | | | |

Notes :

(1) Thermal Resistance : $R\theta_{J-S}$ (Junction to T_s point)

Characteristics Graph

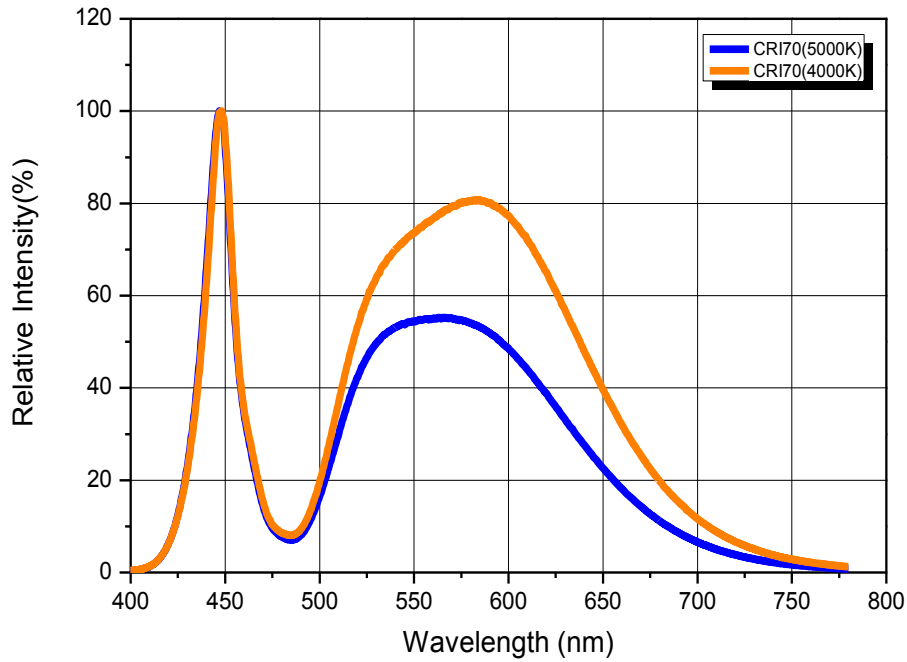
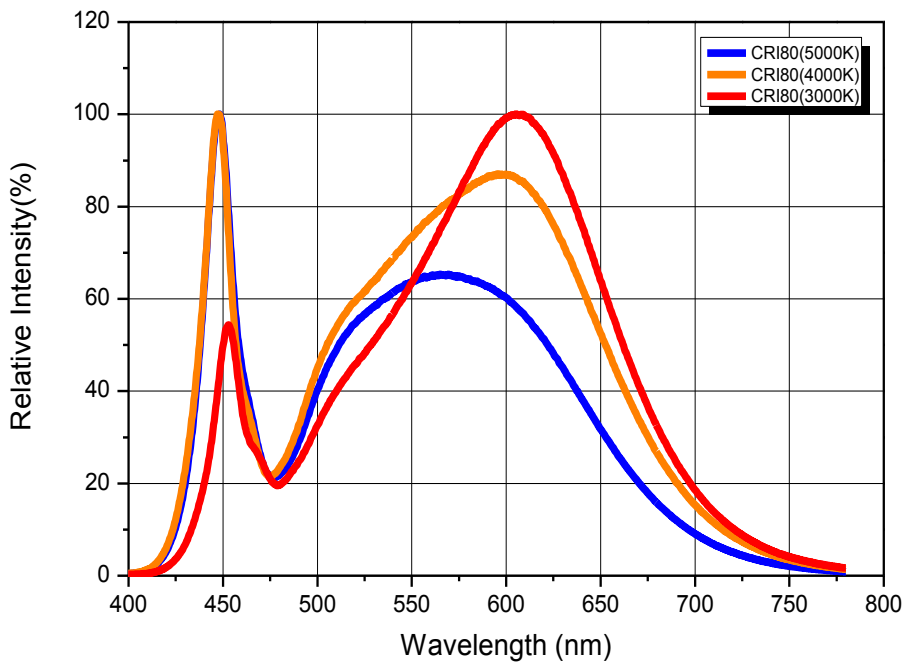
Fig 1. Color Spectrum, $T_j=25^\circ\text{C}$, $I_F=1\text{A}$ (CRI70)

Fig 2. Color Spectrum, $T_j=25^\circ\text{C}$, $I_F=1\text{A}$ (CRI80)

Characteristics Graph

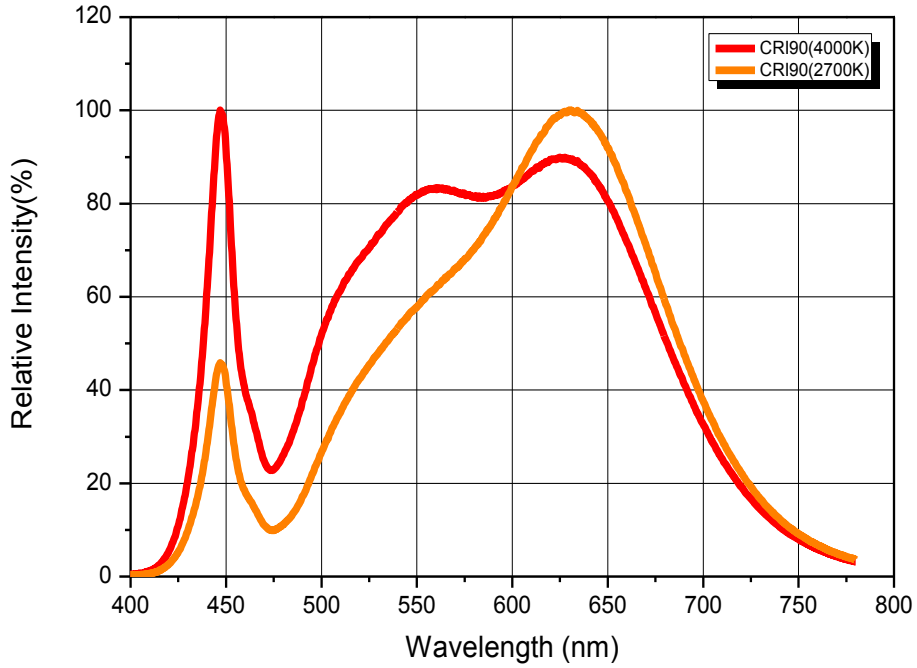
Fig 3. Color Spectrum, $T_j=25^{\circ}\text{C}$, $I_F=1\text{A}$ (CRI90)



Characteristics Graph

Fig 4. Radiant pattern, $T_j=25^{\circ}\text{C}$, $I_F=1\text{A}$

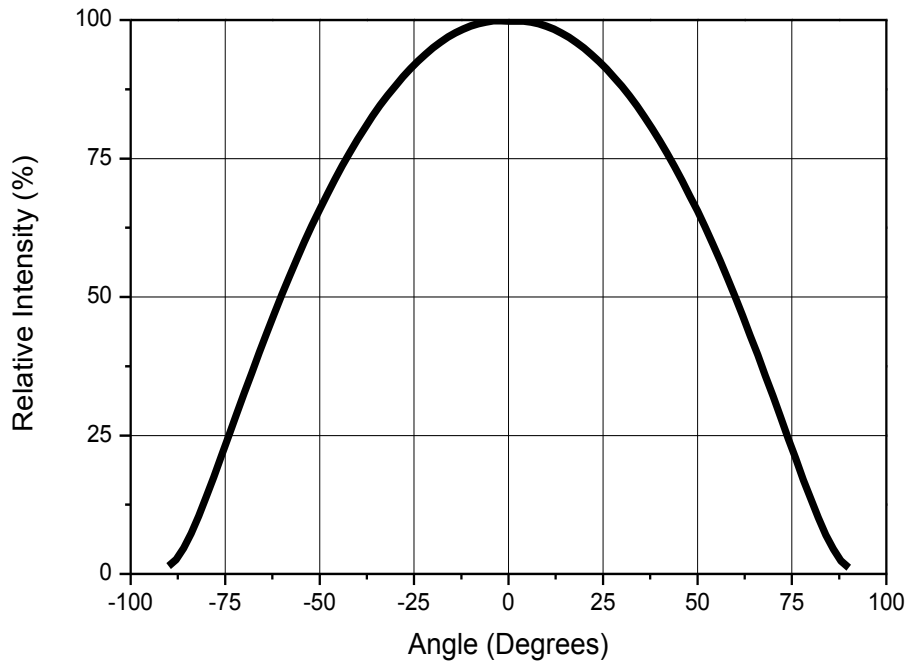

Characteristics Graph

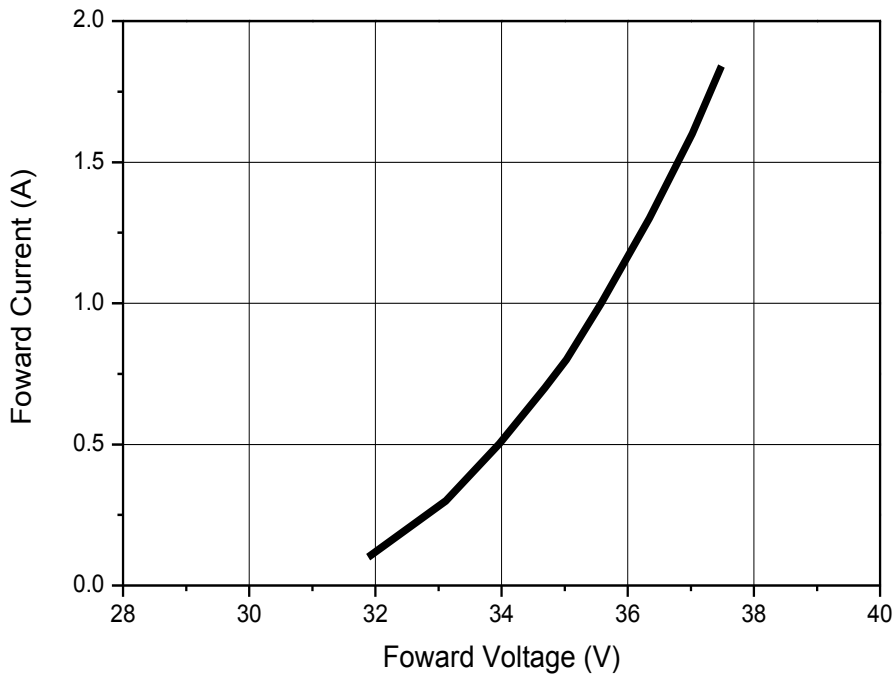
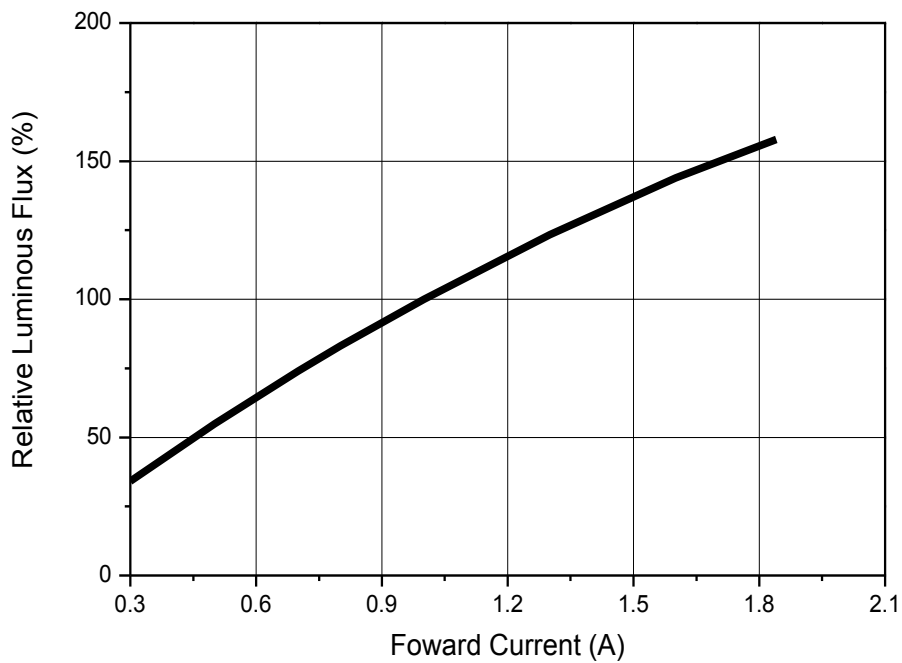
Fig 5. Forward Voltage vs. Forward Current, $T_j=25^\circ\text{C}$

Fig 6. Forward Current vs. Relative Luminous Flux, $T_j=25^\circ\text{C}$

Characteristics Graph

Fig 7. Junction Temperature vs. Relative Light Output, $I_F=1A$

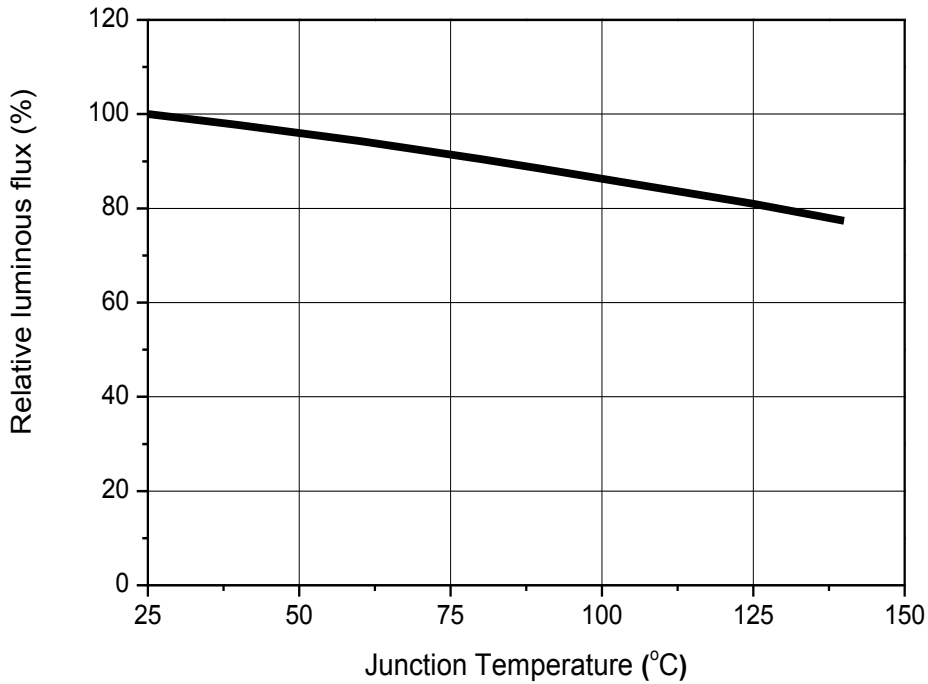
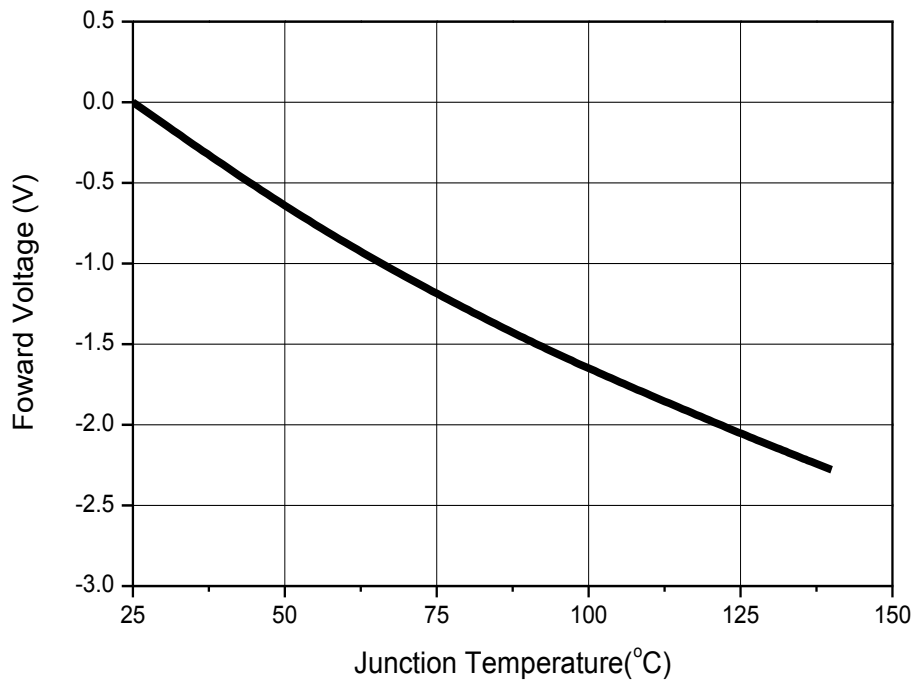

Fig 8. Junction Temperature vs. Forward Voltage, $I_F=1A$



Characteristics Graph

Fig 9. Junction Temperature vs. CIE X, Y Shift, $I_F=1A$ (CRI70)

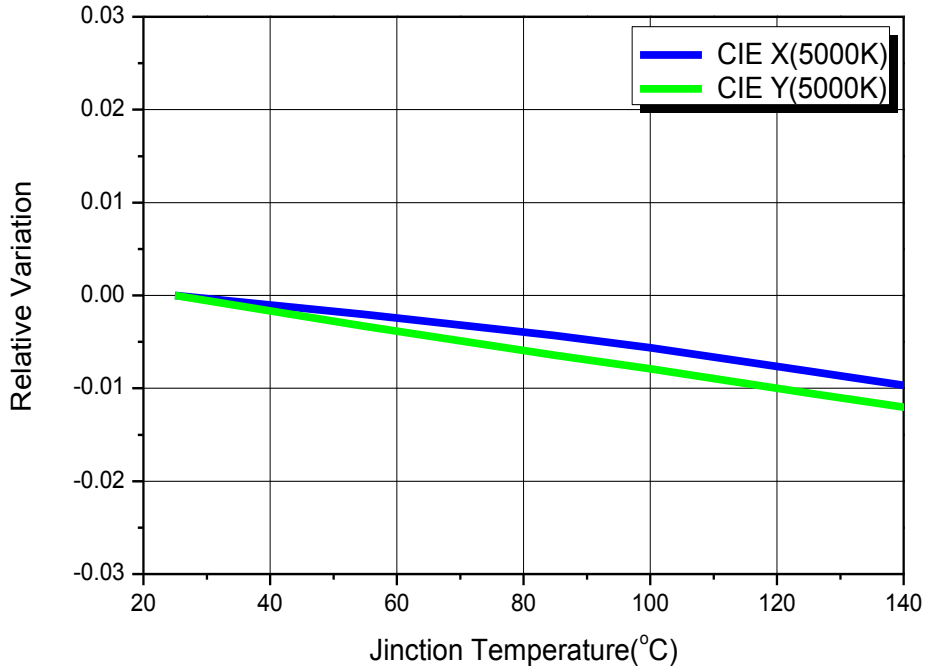
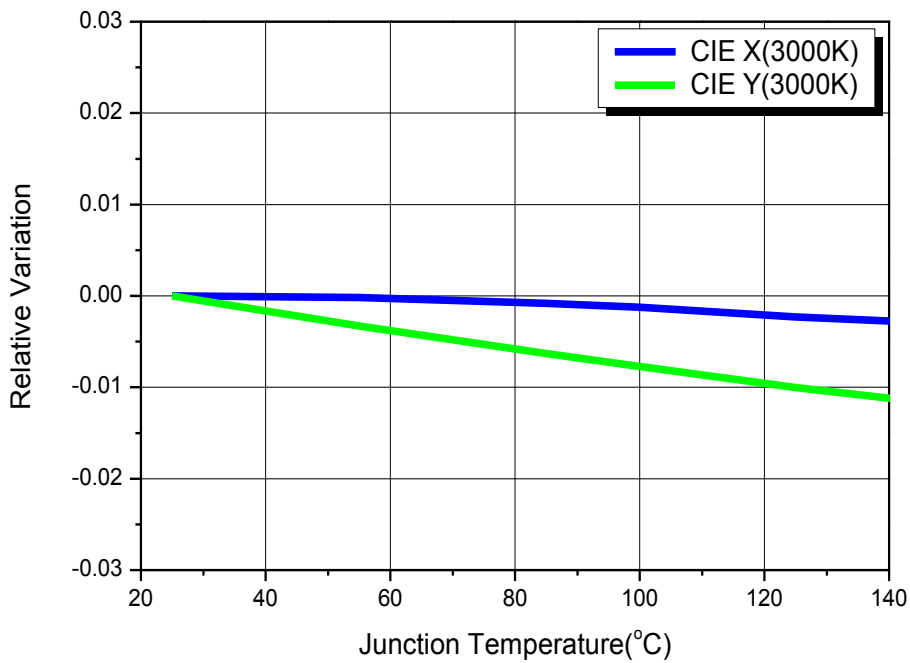
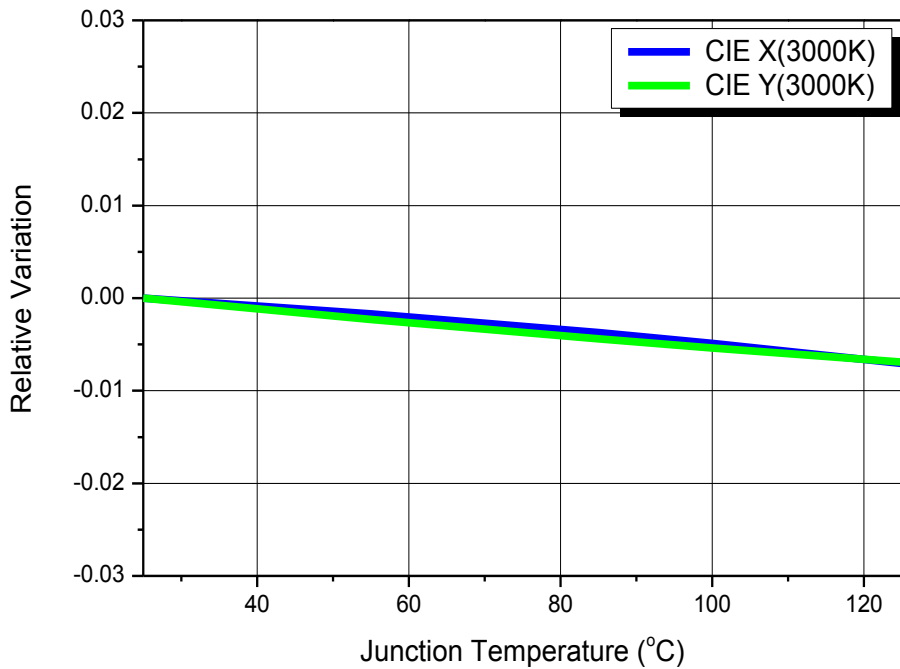
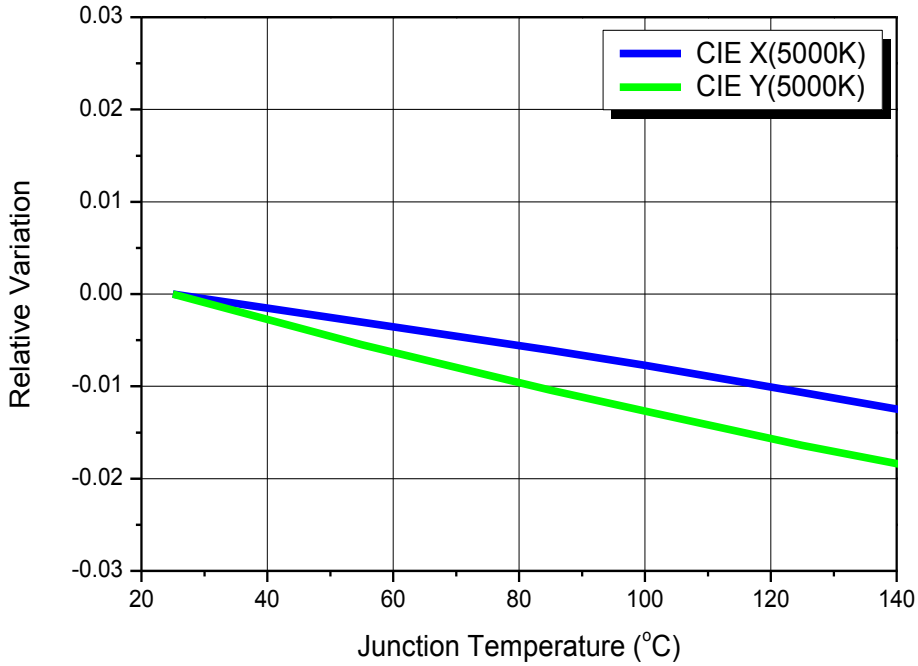

Fig 10. Junction Temperature vs. CIE X, Y Shift, $I_F=1A$ (CRI90)



Characteristics Graph

Fig 11. Junction Temperature vs. CIE X, Y Shift, $I_F=1A$ (CRI80)

Characteristics Graph

Fig 12. Surface Temperature vs. Maximum Forward Current, $T_j(\text{max.})=140^\circ\text{C}$

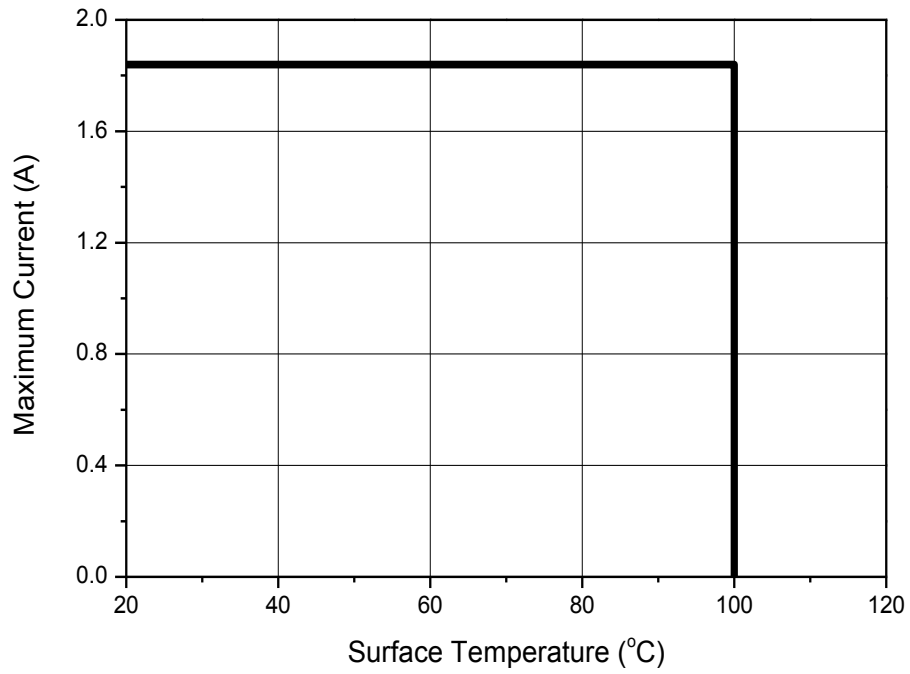

Product Nomenclature

Table 5. Part Numbering System : X₁X₂X₃ X₄X₅ X₆X₇ X₈

| Part Number Code | Description | Part Number | Value |
|-------------------------------|---------------------|-------------|--------------|
| X ₁ | Company | S | |
| X ₂ | Package series | D | |
| X ₃ X ₄ | Color Specification | W0 | CRI 70 |
| | | W8 | CRI 80 |
| | | W9 | CRI 90 |
| X ₅ | Series number | 5 | |
| X ₆ | Lens type | F | Flat |
| X ₇ | PCB type | 1 | PCB |
| X ₈ | Revision number | C | New COB type |

Table 6. Lot Numbering System : Y₁Y₂Y₃Y₄Y₅Y₆ – Y₇Y₈Y₉Y₁₀ – Y₁₁Y₁₂Y₁₃

| Lot Number Code | Description |
|--|-------------|
| Y ₁ Y ₂ | Year |
| Y ₃ Y ₄ | Month |
| Y ₅ Y ₆ | Day |
| Y ₇ Y ₈ Y ₉ Y ₁₀ | Mass order |
| Y ₁₁ Y ₁₂ Y ₁₃ | Tray No. |

Color Bin Structure

CIE Chromaticity Diagram

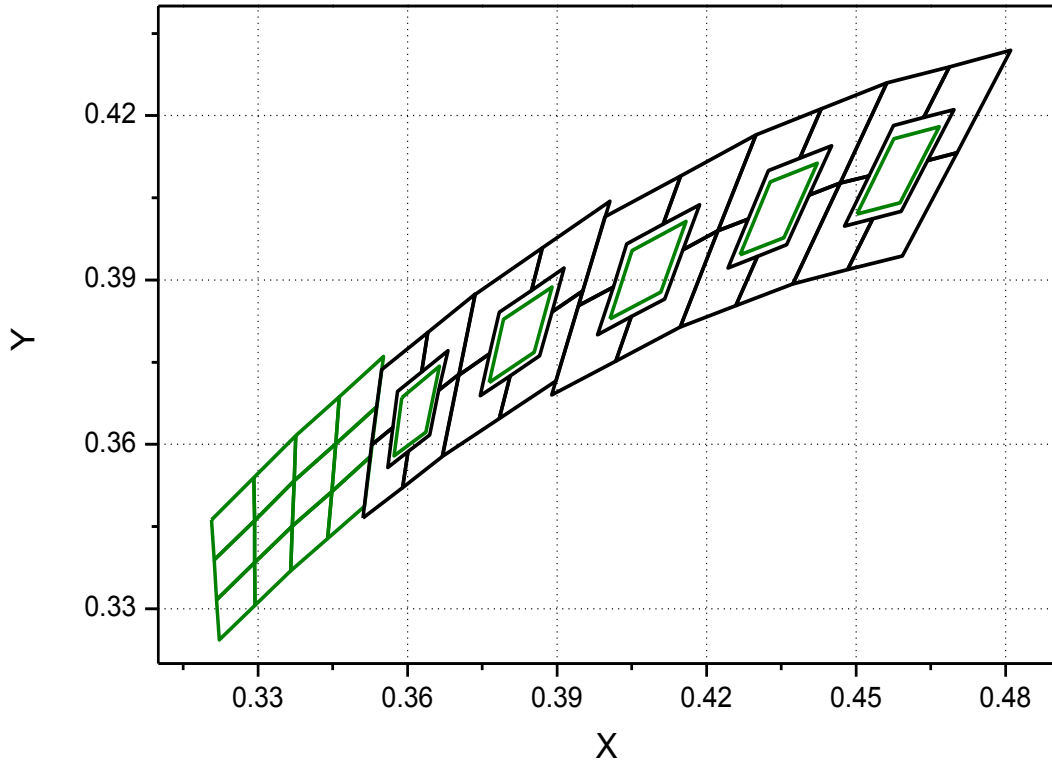

Color Bin Structure

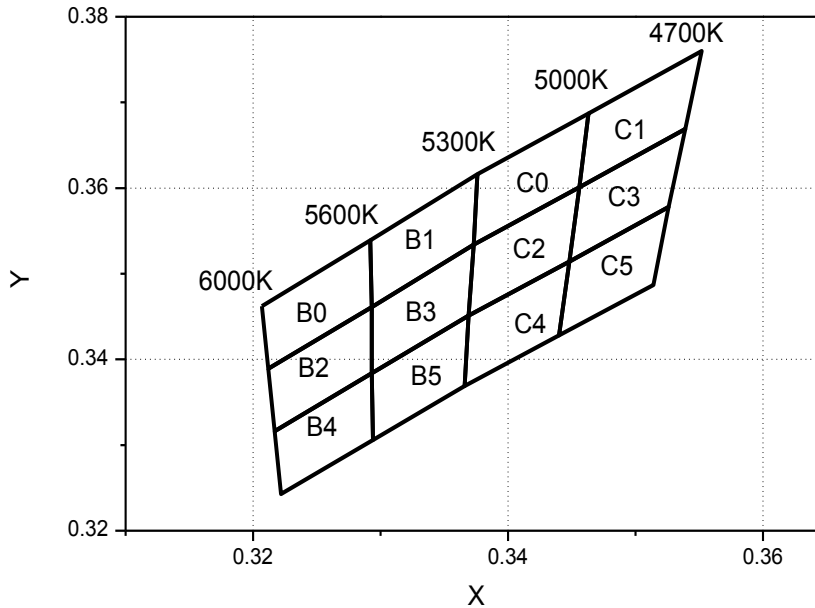
CIE Chromaticity Diagram, $T_j=25^\circ\text{C}$, $I_F=1\text{A}$

| B0 | | B1 | | B2 | |
|--------|--------|--------|--------|--------|--------|
| CIE x | CIE y | CIE x | CIE y | CIE x | CIE y |
| 0.3207 | 0.3462 | 0.3292 | 0.3539 | 0.3212 | 0.3389 |
| 0.3212 | 0.3389 | 0.3293 | 0.3461 | 0.3217 | 0.3316 |
| 0.3293 | 0.3461 | 0.3373 | 0.3534 | 0.3293 | 0.3384 |
| 0.3292 | 0.3539 | 0.3376 | 0.3616 | 0.3293 | 0.3461 |
| B3 | | B4 | | B5 | |
| CIE x | CIE y | CIE x | CIE y | CIE x | CIE y |
| 0.3293 | 0.3461 | 0.3217 | 0.3316 | 0.3293 | 0.3384 |
| 0.3293 | 0.3384 | 0.3222 | 0.3243 | 0.3294 | 0.3306 |
| 0.3369 | 0.3451 | 0.3294 | 0.3306 | 0.3366 | 0.3369 |
| 0.3373 | 0.3534 | 0.3293 | 0.3384 | 0.3369 | 0.3451 |
| C0 | | C1 | | C2 | |
| CIE x | CIE y | CIE x | CIE y | CIE x | CIE y |
| 0.3376 | 0.3616 | 0.3463 | 0.3687 | 0.3373 | 0.3534 |
| 0.3373 | 0.3534 | 0.3456 | 0.3601 | 0.3369 | 0.3451 |
| 0.3456 | 0.3601 | 0.3539 | 0.3669 | 0.3448 | 0.3514 |
| 0.3463 | 0.3687 | 0.3552 | 0.3760 | 0.3456 | 0.3601 |
| C3 | | C4 | | C5 | |
| CIE x | CIE y | CIE x | CIE y | CIE x | CIE y |
| 0.3456 | 0.3601 | 0.3369 | 0.3451 | 0.3448 | 0.3514 |
| 0.3448 | 0.3514 | 0.3366 | 0.3369 | 0.3440 | 0.3428 |
| 0.3526 | 0.3578 | 0.3440 | 0.3428 | 0.3514 | 0.3487 |
| 0.3539 | 0.3669 | 0.3448 | 0.3514 | 0.3526 | 0.3578 |

Color Bin Structure

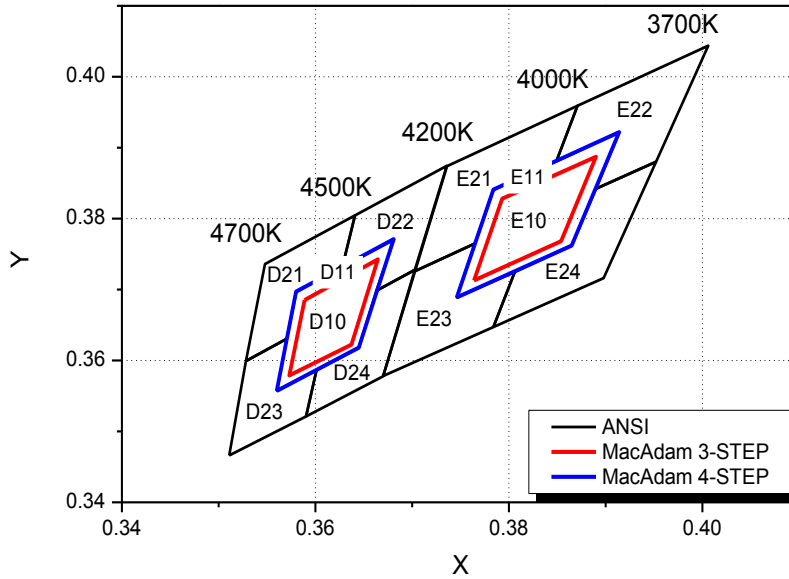
CIE Chromaticity Diagram, $T_j=25^\circ\text{C}$, $I_f=1\text{A}$

| 3-STEP | | | | 4-STEP | | | |
|--------|--------|--------|--------|--------|--------|--------|--------|
| D10 | | E10 | | D11 | | E11 | |
| CIE x | CIE y | CIE x | CIE y | CIE x | CIE y | CIE x | CIE y |
| 0.3589 | 0.3685 | 0.3764 | 0.3713 | 0.3560 | 0.3557 | 0.3746 | 0.3689 |
| 0.3665 | 0.3742 | 0.3793 | 0.3828 | 0.3580 | 0.3697 | 0.3784 | 0.3841 |
| 0.3637 | 0.3622 | 0.3890 | 0.3887 | 0.3681 | 0.3771 | 0.3914 | 0.3922 |
| 0.3573 | 0.3579 | 0.3854 | 0.3768 | 0.3645 | 0.3618 | 0.3865 | 0.3762 |

| ANSI | | | | | | | |
|--------|--------|--------|--------|--------|--------|--------|--------|
| D21 | | D22 | | D23 | | D24 | |
| CIE x | CIE y | CIE x | CIE y | CIE x | CIE y | CIE x | CIE y |
| 0.3528 | 0.3599 | 0.3628 | 0.3732 | 0.3601 | 0.3587 | 0.3511 | 0.3466 |
| 0.3548 | 0.3736 | 0.3641 | 0.3805 | 0.3645 | 0.3618 | 0.3528 | 0.3599 |
| 0.3641 | 0.3805 | 0.3736 | 0.3874 | 0.3663 | 0.3699 | 0.3570 | 0.3631 |
| 0.3628 | 0.3732 | 0.3703 | 0.3728 | 0.3703 | 0.3728 | 0.3560 | 0.3558 |
| 0.3580 | 0.3697 | 0.3663 | 0.3699 | 0.3670 | 0.3578 | 0.3601 | 0.3587 |
| 0.3570 | 0.3631 | 0.3681 | 0.3771 | 0.3590 | 0.3521 | 0.3590 | 0.3521 |
| E21 | | E22 | | E23 | | E24 | |
| CIE x | CIE y | CIE x | CIE y | CIE x | CIE y | CIE x | CIE y |
| 0.3703 | 0.3726 | 0.3890 | 0.3842 | 0.3670 | 0.3578 | 0.3784 | 0.3647 |
| 0.3736 | 0.3874 | 0.3914 | 0.3922 | 0.3703 | 0.3726 | 0.3806 | 0.3725 |
| 0.3871 | 0.3959 | 0.3849 | 0.3881 | 0.3765 | 0.3765 | 0.3865 | 0.3762 |
| 0.3849 | 0.3881 | 0.3871 | 0.3959 | 0.3746 | 0.3689 | 0.3890 | 0.3842 |
| 0.3784 | 0.3841 | 0.4006 | 0.4044 | 0.3806 | 0.3725 | 0.3952 | 0.3880 |
| 0.3765 | 0.3765 | 0.3952 | 0.3880 | 0.3784 | 0.3647 | 0.3898 | 0.3716 |

Color Bin Structure

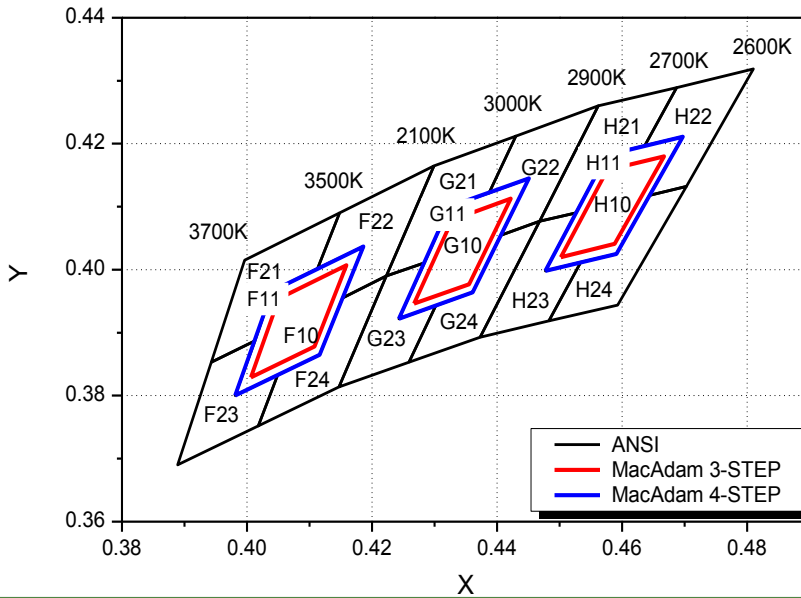
CIE Chromaticity Diagram, $T_j=25^\circ\text{C}$, $I_f=1\text{A}$

| 3-STEP | | | | | | 4-STEP | | | | | |
|--------|--------|--------|--------|--------|--------|--------|--------|--------|--------|--------|--------|
| F10 | | G10 | | H10 | | F11 | | G11 | | H11 | |
| CIE x | CIE y | CIE x | CIE y | CIE x | CIE y | CIE x | CIE y | CIE x | CIE y | CIE x | CIE y |
| 0.4006 | 0.3829 | 0.4267 | 0.3946 | 0.4502 | 0.4020 | 0.3981 | 0.3800 | 0.4243 | 0.3922 | 0.4477 | 0.3998 |
| 0.4051 | 0.3954 | 0.4328 | 0.4079 | 0.4576 | 0.4158 | 0.4040 | 0.3966 | 0.4324 | 0.4100 | 0.4575 | 0.4182 |
| 0.4159 | 0.4007 | 0.4422 | 0.4113 | 0.4667 | 0.4180 | 0.4186 | 0.4037 | 0.4451 | 0.4145 | 0.4697 | 0.4211 |
| 0.4108 | 0.3878 | 0.4355 | 0.3977 | 0.4588 | 0.4041 | 0.4116 | 0.3865 | 0.4361 | 0.3964 | 0.4591 | 0.4025 |
| ANSI | | | | | | | | | | | |
| F21 | | F22 | | F23 | | F24 | | | | | |
| CIE x | CIE y | CIE x | CIE y | CIE x | CIE y | CIE x | CIE y | | | | |
| 0.4148 | 0.4090 | 0.4013 | 0.3887 | 0.4223 | 0.3990 | 0.4299 | 0.4165 | | | | |
| 0.3996 | 0.4015 | 0.3943 | 0.3853 | 0.4153 | 0.3955 | 0.4148 | 0.4090 | | | | |
| 0.3943 | 0.3853 | 0.3889 | 0.3690 | 0.4116 | 0.3865 | 0.4113 | 0.4002 | | | | |
| 0.4013 | 0.3887 | 0.4018 | 0.3752 | 0.4049 | 0.3833 | 0.4186 | 0.4037 | | | | |
| 0.4040 | 0.3966 | 0.4049 | 0.3833 | 0.4018 | 0.3752 | 0.4153 | 0.3955 | | | | |
| 0.4113 | 0.4002 | 0.3981 | 0.3800 | 0.4147 | 0.3814 | 0.4223 | 0.3990 | | | | |
| G21 | | G22 | | G23 | | G24 | | | | | |
| CIE x | CIE y | CIE x | CIE y | CIE x | CIE y | CIE x | CIE y | | | | |
| 0.4223 | 0.3990 | 0.4406 | 0.4055 | 0.4147 | 0.3814 | 0.4259 | 0.3853 | | | | |
| 0.4299 | 0.4165 | 0.4451 | 0.4145 | 0.4223 | 0.3990 | 0.4302 | 0.3943 | | | | |
| 0.4430 | 0.4212 | 0.4387 | 0.4122 | 0.4284 | 0.4011 | 0.4361 | 0.3964 | | | | |
| 0.4387 | 0.4122 | 0.4430 | 0.4212 | 0.4243 | 0.3922 | 0.4406 | 0.4055 | | | | |
| 0.4324 | 0.4100 | 0.4562 | 0.4260 | 0.4302 | 0.3943 | 0.4468 | 0.4077 | | | | |
| 0.4284 | 0.4011 | 0.4468 | 0.4077 | 0.4259 | 0.3853 | 0.4373 | 0.3893 | | | | |
| H21 | | H22 | | H23 | | H24 | | | | | |
| CIE x | CIE y | CIE x | CIE y | CIE x | CIE y | CIE x | CIE y | | | | |
| 0.4468 | 0.4077 | 0.4644 | 0.4118 | 0.4373 | 0.3893 | 0.4483 | 0.3919 | | | | |
| 0.4562 | 0.4260 | 0.4697 | 0.4211 | 0.4468 | 0.4077 | 0.4534 | 0.4012 | | | | |
| 0.4687 | 0.4289 | 0.4636 | 0.4197 | 0.4526 | 0.4090 | 0.4591 | 0.4025 | | | | |
| 0.4636 | 0.4197 | 0.4687 | 0.4289 | 0.4477 | 0.3998 | 0.4644 | 0.4118 | | | | |
| 0.4575 | 0.4182 | 0.4810 | 0.4319 | 0.4534 | 0.4012 | 0.4703 | 0.4132 | | | | |
| 0.4526 | 0.4090 | 0.4703 | 0.4132 | 0.4483 | 0.3919 | 0.4593 | 0.3944 | | | | |

Color Bin Structure

Table 7. Bin Code description

| Part Number | Luminous Flux (lm) @ I _F = 1A | | | Color Chromaticity Coordinate @ I _F = 1A | Typical Forward Voltage (V _F) @ I _F = 1A | | |
|-------------|---|------|------|--|--|------|------|
| | Bin Code | Min. | Max. | | Bin Code | Min. | Max. |
| SDW05F1C | K1 | 3900 | 4500 | Refer to page.15~17 | D | 32.0 | 34.0 |
| | K2 | 4500 | 5100 | | E | 34.0 | 38.0 |
| | L1 | 5100 | 5800 | | F | 38.0 | 40.0 |
| SDW85F1C | J2 | 3400 | 3900 | Refer to page.15~18 | D | 32.0 | 34.0 |
| | K1 | 3900 | 4500 | | E | 34.0 | 38.0 |
| | K2 | 4500 | 5100 | | F | 38.0 | 40.0 |
| SDW95F1C | J1 | 2900 | 3400 | Refer to page.15~18 | D | 32.0 | 34.0 |
| | J2 | 3400 | 3900 | | E | 34.0 | 38.0 |
| | K1 | 3900 | 4500 | | F | 38.0 | 40.0 |

Table 8. Ordering Information(Bin Code)

Available ranks

| Part Number | CCT | CIE | LF rank | | | VF rank | | |
|-------------|------------|-----|---------|----|----|---------|---|---|
| SDW05F1C | 5300~6000K | B | K1 | K2 | L1 | D | E | F |
| | 4700~5300K | C | K1 | K2 | L1 | D | E | F |
| | 4200~4700K | D | K1 | K2 | L1 | D | E | F |
| | 3700~4200K | E | K1 | K2 | L1 | D | E | F |
| SDW85F1C | 5300~6000K | B | J2 | K1 | K2 | D | E | F |
| | 4700~5300K | C | J2 | K1 | K2 | D | E | F |
| | 3700~4200K | E | J2 | K1 | K2 | D | E | F |
| | 3200~3700K | F | J2 | K1 | K2 | D | E | F |
| | 2900~3700K | G | J2 | K1 | K2 | D | E | F |
| | 2600~2900K | H | J2 | K1 | K2 | D | E | F |
| SDW95F1C | 3700~4200K | E | J1 | J2 | K1 | D | E | F |
| | 3200~3700K | F | J1 | J2 | K1 | D | E | F |
| | 2900~3700K | G | J1 | J2 | K1 | D | E | F |
| | 2600~2900K | H | J1 | J2 | K1 | D | E | F |

Mechanical Dimensions

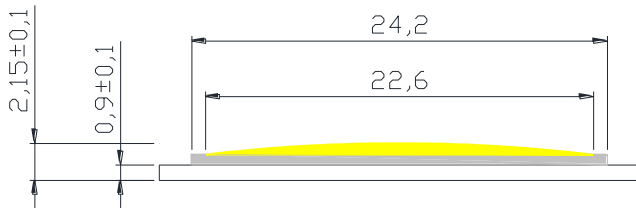
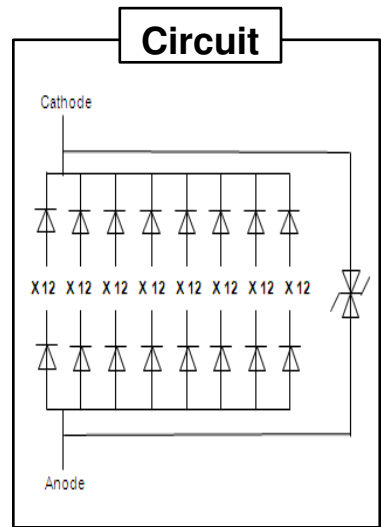
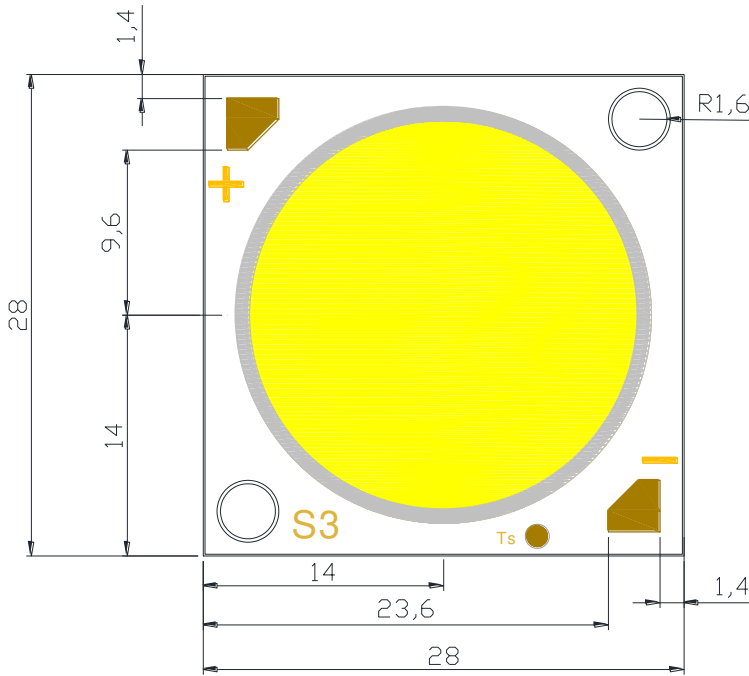

Notes :

- (1) All dimensions are in millimeters.
- (2) Scale : none
- (3) Undefined tolerance is $\pm 0.2\text{mm}$

Packaging Specification

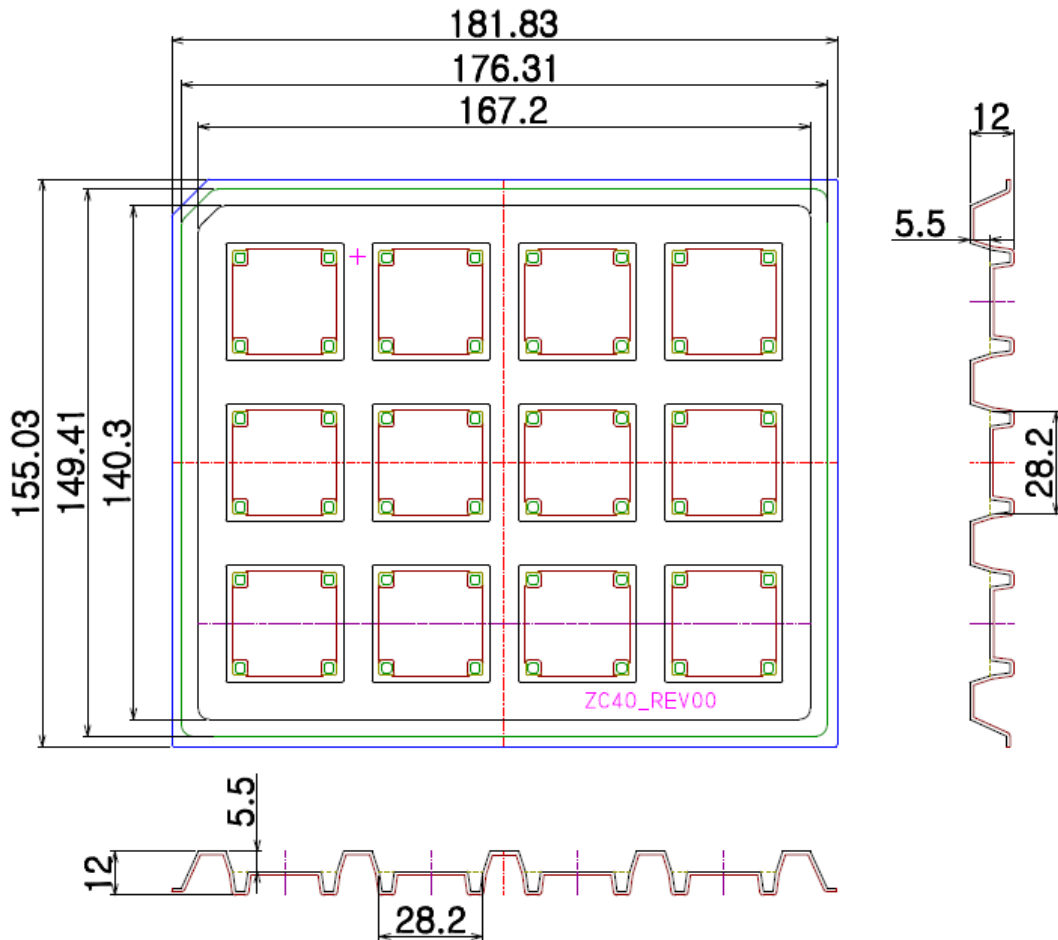

Notes :

- (1) Quantity : 12pcs/Tray
- (2) All dimensions are in millimeters (tolerance : ± 0.3)
- (3) Scale none

Packaging Specification

Aluminum Bag

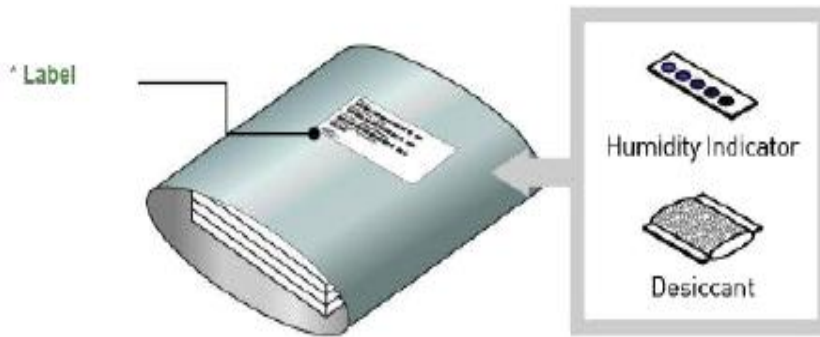

Outer Box

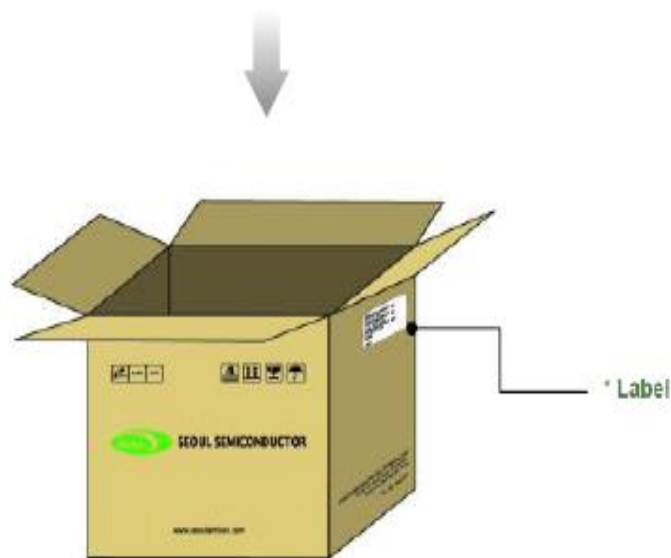

Notes :

- (1) Heat Sealed after packing (Use Zipper Bag)
- (2) Quantity : 3Tray(36pcs) /Bag

Handling of Silicone Resin for LEDs

- (1) During processing, mechanical stress on the surface should be minimized as much as possible. Sharp objects of all types should not be used to pierce the sealing compound.



- (2) In general, LEDs should only be handled from the side. By the way, this also applies to LEDs without a silicone sealant, since the surface can also become scratched.

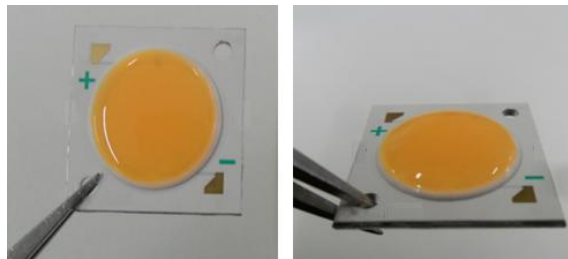

- (3) Silicone differs from materials conventionally used for the manufacturing of LEDs. These conditions must be considered during the handling of such devices. Compared to standard encapsulants, silicone is generally softer, and the surface is more likely to attract dust. As mentioned previously, the increased sensitivity to dust requires special care during processing. In cases where a minimal level of dirt and dust particles cannot be guaranteed, a suitable cleaning solution must be applied to the surface after the soldering of wire.
- (4) Seoul Semiconductor suggests using isopropyl alcohol for cleaning. In case other solvents are used, it must be assured that these solvents do not dissolve the package or resin. Ultrasonic cleaning is not recommended. Ultrasonic cleaning may cause damage to the LED.
- (5) Please do not mold this product into another resin (epoxy, urethane, etc) and do not handle this product with acid or sulfur material in sealed space.
- (6) Avoid leaving fingerprints on silicone resin parts.

Precaution for Use

(1) Storage

To avoid the moisture penetration, we recommend storing Power LEDs in a dry box with a desiccant.

The recommended storage temperature range is 5 °C to 30 °C and a maximum humidity of 50%.

(2) Use Precaution after Opening the Packaging. Pay attention to the following:

a. Recommend conditions after opening the package

- Sealing

- Temperature : 5 ~ 40 °C Humidity : less than RH30%

b. If the package has been opened more than 4 week or the color of the desiccant changes.

(3) For manual soldering

Seoul Semiconductor recommends the soldering condition

(ZC series product is not adaptable to reflow process)

a. Use lead-free soldering

b. Soldering should be implemented using a soldering equipment at temperature lower than 350 °C.

c. Before proceeding the next step, product temperature must be stabilized at room temperature.

(4) Components should not be mounted on warped (non coplanar) portion of PCB.

(5) Radioactive exposure is not considered for the products listed here in.

(6) It is dangerous to drink the liquid or inhale the gas generated by such products when chemically disposed of.

(7) This device should not be used in any type of fluid such as water, oil, organic solvent and etc. When washing is required, IPA (Isopropyl Alcohol) should be used.

(8) When the LEDs are in operation the maximum current should be decided after measuring the package temperature.

(9) LEDs must be stored properly to maintain the device. If the LEDs are stored for 3 months or more after being shipped from Seoul Semiconductor, a sealed container with vacuum atmosphere should be used for storage.

(10) The appearance and specifications of the product may be modified for improvement without notice.

Precaution for Use

- (11) Long time exposure of sun light or occasional UV exposure will cause silicone discoloration.
- (12) Attaching LEDs, do not use adhesive that outgas organic vapor.
- (13) The driving circuit must be designed to allow forward voltage only when it is ON or OFF. If the reverse voltage is applied to LED, migration can be generated resulting in LED damage.
- (14) Please do not touch any of the circuit board, components or terminals with bare hands or metal while circuit is electrically active.
- (15) VOCs (Volatile organic compounds) emitted from materials used in the construction of fixtures can penetrate silicone encapsulants of LEDs and discolor when exposed to heat and photonic energy. The result can be a significant loss of light output from the fixture. Knowledge of the properties of the materials selected to be used in the construction of fixtures can help prevent these issues.
- (16) LEDs are sensitive to Electro-Static Discharge (ESD) and Electrical Over Stress (EOS). Below is a list of suggestions that Seoul Semiconductor purposes to minimize these effects.

I . ESD (Electro Static Discharge)

Electrostatic discharge (ESD) is defined as the release of static electricity when two objects come into contact. While most ESD events are considered harmless, it can be an expensive problem in many industrial environments during production and storage. The damage from ESD to LEDs may cause the product to demonstrate unusual characteristics such as:

- Increase in reverse leakage current lowered turn-on voltage
- Abnormal emissions from the LED at low current

The following recommendations are suggested to help minimize the potential for an ESD event. One or more recommended work area suggestions:

- Ionizing fan setup
- ESD table/shelf mat made of conductive materials
- ESD safe storage containers

One or more personnel suggestion options:

- Antistatic wrist-strap
- Antistatic material shoes
- Antistatic clothes

Environmental controls:

- Humidity control (ESD gets worse in a dry environment)