



Chipsmall Limited consists of a professional team with an average of over 10 year of expertise in the distribution of electronic components. Based in Hongkong, we have already established firm and mutual-benefit business relationships with customers from,Europe,America and south Asia,supplying obsolete and hard-to-find components to meet their specific needs.

With the principle of “Quality Parts,Customers Priority,Honest Operation,and Considerate Service”,our business mainly focus on the distribution of electronic components. Line cards we deal with include Microchip,ALPS,ROHM,Xilinx,Pulse,ON,Everlight and Freescale. Main products comprise IC,Modules,Potentiometer,IC Socket,Relay,Connector.Our parts cover such applications as commercial,industrial, and automotives areas.

We are looking forward to setting up business relationship with you and hope to provide you with the best service and solution. Let us make a better world for our industry!



Contact us

Tel: +86-755-8981 8866 Fax: +86-755-8427 6832

Email & Skype: info@chipsmall.com Web: www.chipsmall.com

Address: A1208, Overseas Decoration Building, #122 Zhenhua RD., Futian, Shenzhen, China



DATA SHEET

SE2433T: 2.4 GHz Power Amplifier

Applications

- ISM band applications
- Smart meters
- In-home appliances
- Smart thermostats
- Remote controls

Features

- Suitable for Zigbee®, Bluetooth® Low Energy, and Bluetooth 1.0
- High output power at +24 dBm
- Integrated interstage matching
- Integrated 50 Ω input matching
- Fast switch ON/OFF time <1 μs
- 2.0 V to 3.6 V supply operation
- Standby current <1 μA
- QFN package (12-pin, 2.5 x 2 x 0.55 mm, (MSL1, 260 °C per JEDEC J-STD-020)

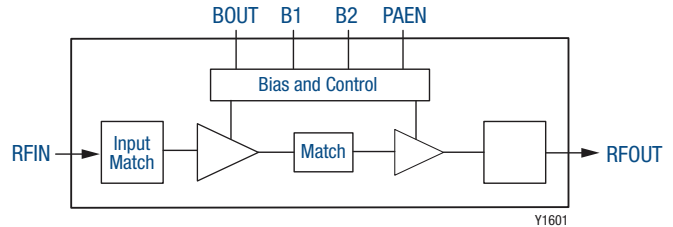

Figure 1. SE2433T Block Diagram

Description

The SE2433T is a high-performance power amplifier, suitable for Zigbee, Bluetooth Low Energy, and Bluetooth 1.0 applications. The SE2433T is designed for ease of use and maximum flexibility, with an integrated input match and a digital enable control for Complementary Metal Oxide Semiconductor (CMOS) compatible device on/off control.

A functional block diagram of the SE2433T is provided in Figure 1. Figure 2 shows the pinout for the SE2433T. Table 1 lists the pin assignments and signal descriptions.



Skyworks Green™ products are compliant with all applicable legislation and are halogen-free. For additional information, refer to *Skyworks Definition of Green™*, document number SQ04-0074.

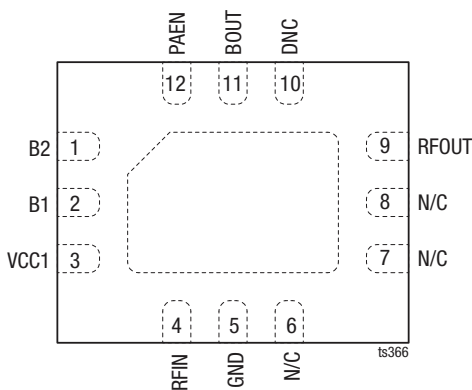

N/C pins can be connected to ground, but the DNC pin should be left floating

Figure 2. SE2433T Pinout (Top View)

Table 1. SE2433T Signal Descriptions (Note 1)

Pin	Name	Description	Pin	Name	Description
1	B2	Connect through bias resistor to Pin 11, second stage bias.	7	N/C	Not connected.
2	B1	Connect through bias resistor to Pin 11, first stage bias.	8	N/C	Not connected.
3	VCC1	Power supply. Connect to positive supply.	9	RFOUT	RF output port.
4	RFIN	Input port, Connect to 50 Ω single-ended RF source, DC short to GND.	10	DNC	Do not connect.
5	GND	Ground. Connect to PCB ground.	11	BOUT	Bias supply, Connect to through bias resistors to pins 1 and 2.
6	N/C	Not connected.	12	PAEN	PA enable, Connect to GPIO signal to control power-up status (see Table 7) .
			Paddle	GND	Exposed die paddle; electrical and thermal ground; Connect to PCB ground.

Note 1: The N/C pins can be connected to ground, but the DNC pin should be left floating.

Electrical and Mechanical Specifications

Table 2 provides the absolute maximum ratings, and Table 3 shows the recommended operating conditions. Electrical characteristics are shown in Tables 4 and 5.

Logic characteristics and logic controls are provided in Tables 6 and 7, respectively.

Typical performance characteristics are shown in Figures 3 through 14.

Table 2. SE2433T Absolute Maximum Ratings (Note 1)

Parameter	Symbol	Minimum	Maximum	Units
Supply voltage	VCC	-0.3	3.6	V
Control pin voltages		-0.3	3.6	V
Operating temperature	T _{OP}	-0.3	85	°C
Storage temperature	T _{STG}	-40	125	°C
TX input power	P _{IN_MAX}	-40	+6	dBm
Electrostatic discharge: Human Body Model (HBM), Class 1B	ESD		500	V

Note 1: Exposure to maximum rating conditions for extended periods may reduce device reliability. There is no damage to device with only one parameter set at the limit and all other parameters set at or below their nominal value. Exceeding any of the limits listed here may result in permanent damage to the device.

CAUTION: Although this device is designed to be as robust as possible, electrostatic discharge (ESD) can damage this device. This device must be protected at all times from ESD. Static charges may easily produce potentials of several kilovolts on the human body or equipment, which can discharge without detection. Industry-standard ESD precautions should be used at all times.

Table 3. SE2433T Recommended Operating Conditions

Parameter	Symbol	Minimum	Typical	Maximum	Units
Ambient temperature	T _A	-40	+25	+85	°C
Supply voltage on VCC	V _{CC}	2.0	3.0	3.6	V

Table 4. SE2433T Electrical Specifications: DC Electrical Characteristics

(V_{CC} = 3.0 V, T_A = +25 °C, as Measured on the Evaluation Board [De-Embedded to Device], All Unused Ports Terminated at 50 Ω, Unless Otherwise Noted)

Parameter	Symbol	Condition	Min	Typ	Max	Unit
Total supply current	I _{CC-Tx20} I _{CC-Tx17} I _{CC-Tx10}	P _{OUT} = +20 dBm P _{OUT} = +18 dBm P _{OUT} = +12 dBm		100 80 50		mA mA mA
Quiescent current	I _{CC}	No RF		25		mA
OFF supply current	I _{CC_OFF}	PAEN = 0 V, No RF			1	μA

Table 5. SE2433T Electrical Specifications: AC Electrical Characteristics

(V_{CC} = 3.0 V, PAEN = 3.0 V, T_A = 25 °C, as Measured on the Evaluation Board [De-Embedded to Device], All Unused Ports Terminated with 50 Ω, Unless Otherwise Noted)

Parameter	Symbol	Test Condition	Min	Typ	Max	Unit
Frequency	f		2400		2483	MHz
Output power (Notes 1 and 5)	P _{OUT}	V _{CC} = 3.6 V, P _{IN} = +5.5 dBm V _{CC} = 3.3 V, P _{IN} = +5.5 dBm V _{CC} = 3.0 V, P _{IN} = +2 dBm V _{CC} = 2.7 V, P _{IN} = 0 dBm V _{CC} = 2.0 V, P _{IN} = 0 dBm V _{CC} = 3.0 V, P _{IN} = -11 dBm		+24.5 +23.0 +20.0 +19.0 +17.0 +10		dBm dBm dBm dBm dBm dBm
Small signal gain high-power mode	S ₂₁	2400 to 2483 MHz	19.5	22	24	dB
Small signal gain variation (Note 1)	ΔS ₂₁	Gain variation across channels, 2400 to 2483 MHz			1	dBp-p
Harmonics (Notes 1, 2, and 6)	HD ₂ , HD ₃	P _{OUT} = +20 dBm			-42	dBm/MHz
Turn-on time (Note 3)	t _R				800	ns
Turn-off time (Note 4)	t _F				800	ns
Stability	STAB	CW, P _{IN} = 0 dBm, 0.1 GHz to 20 GHz, load VSWR = 6:1	All non-harmonically related outputs less than -42 dBm/MHz			
Ruggedness	RU	CW, P _{IN} = +6 dBm, load VSWR = 10:1	No permanent damage			

Note 1: 2400 to 2483 MHz.

Note 2: IEEE 802.15.4 source.

Note 3: From 50% of PAEN edge to 90% of final RF output power.

Note 4: From 50% of PAEN edge to 10% of final RF output power.

Note 5: OEVM = 1% max.

Note 6: Using recommended output matching network.

Table 6. SE2433T Logic Characteristics

(V_{CC} = 3.0 V, T_A = +25 °C, as Measured on the Evaluation Board [De-Embedded to Device], All Unused Ports Terminated with 50 Ω, Unless Otherwise Noted)

Parameter	Symbol	Min	Typ	Max	Unit
Logic input high	V _{IH}	1.6		3.6	V
Logic input low	V _{IL}	0		0.3	V
Logic input high	I _{IH}			1	μA
Logic input low	I _{IL}			1	μA

Table 7. SE2433T Logic Controls

(V_{CC} = 3.0 V, T_A = +25 °C)

Mode	Mode Description	PAEN
0	PA disabled	0
1	PA enabled	1

Note 1: Logic '0' level compliant to V_{IL} as specified in Table 6.

Note 2: Logic '1' level compliant to V_{IH} as specified in Table 6.

Typical Performance Characteristics

($V_{CC} = V_{DD} = 3\text{ V}$, $T_A = +25\text{ }^\circ\text{C}$, $f = 2.44\text{ GHz}$, ZigBee Signal with Symbol Rate = 1 Msps, Unless Otherwise Noted)

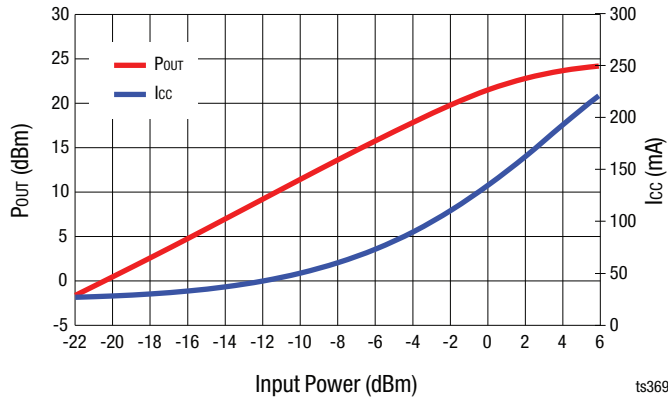

Figure 3. Pout and Icc vs Pin, CW

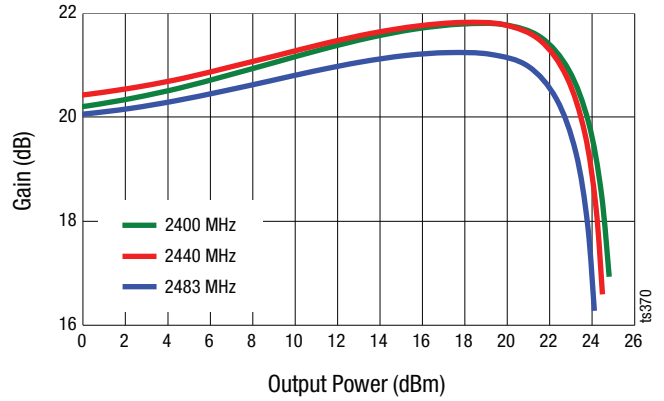

Figure 4. Gain vs Pout, CW

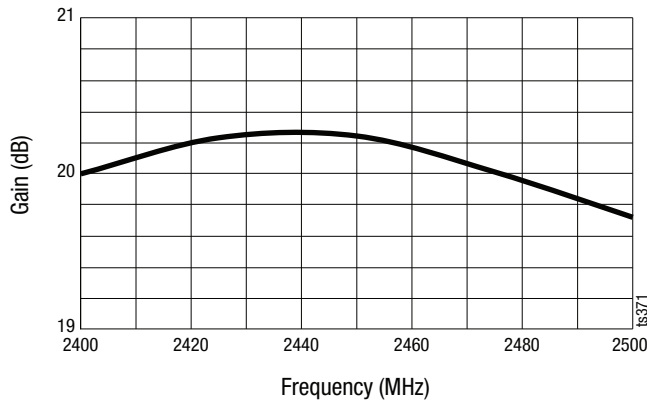

Figure 5. Small Signal Gain vs Frequency, CW

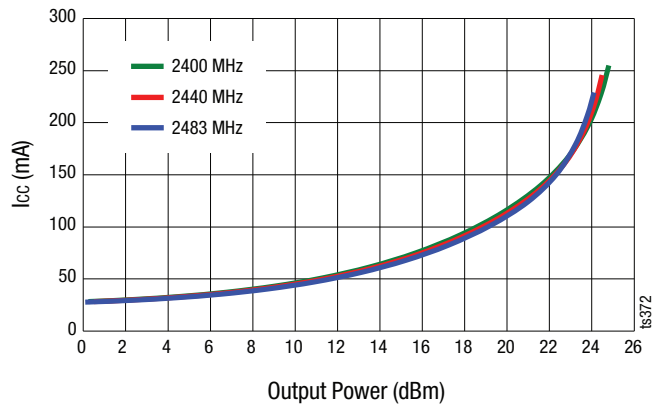

Figure 6. Icc vs Pout, CW

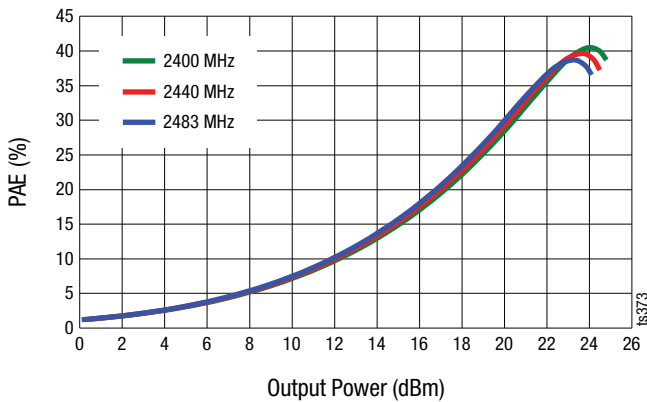

Figure 7. PAE vs Pout, CW

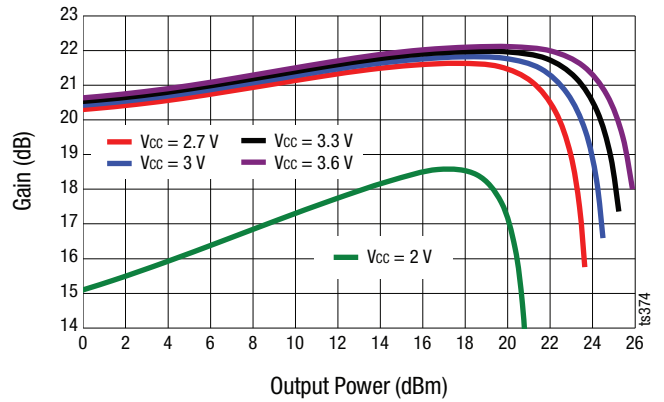

Figure 8. Gain vs Pout and Vcc, CW

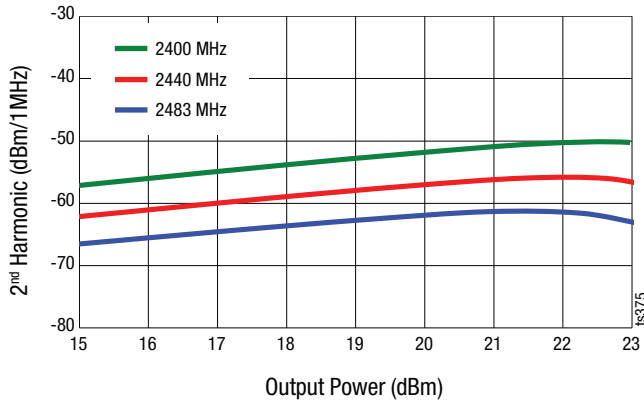

Figure 9. 2nd Harmonic vs Pout, Zigbee

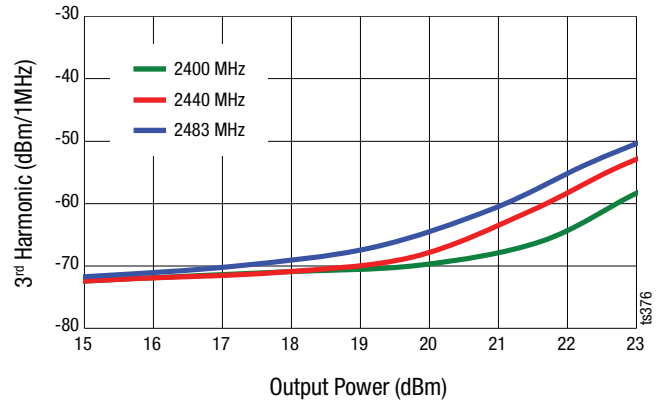

Figure 10. 3rd Harmonic vs Pout, Zigbee

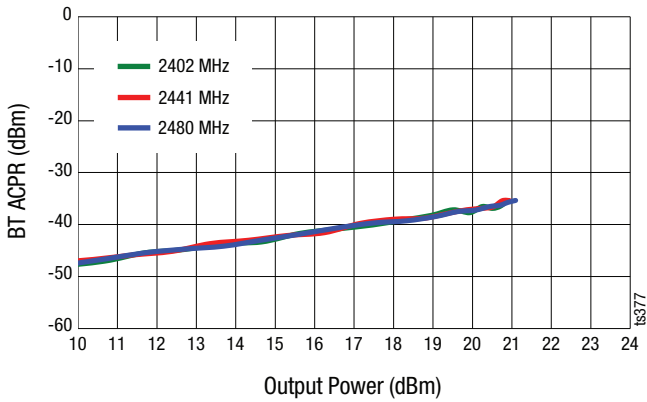

Figure 11. BT ACPR CH-2 vs Pout, BT-BDR-DH1

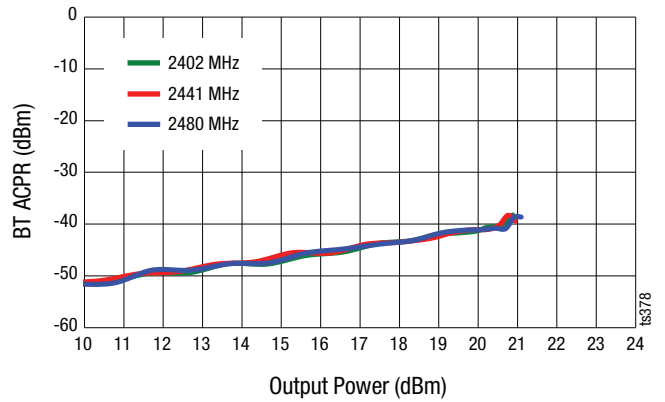

Figure 12. BT ACPR CH-3 vs Pout, BT-BDR-DH1

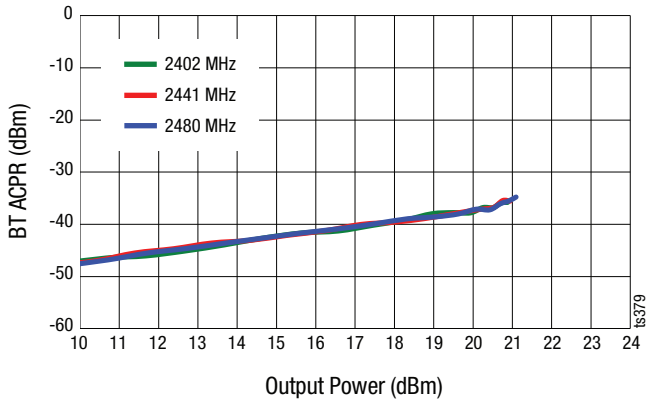

Figure 13. BT ACPR CH+2 vs Pout, BT-BDR-DH1

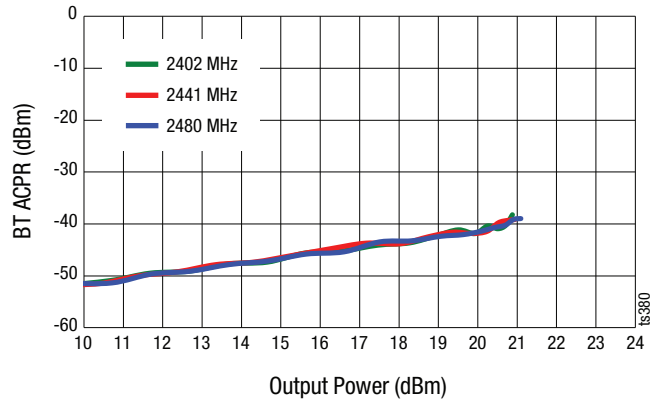

Figure 14. BT ACPR CH+3 vs Pout, BT-BDR-DH1

Evaluation Board Description

The SE2433T Evaluation Board is used to test the performance of the SE2433T FEM. The Evaluation Board schematic diagram is shown in Figure 15. A reference design schematic is shown in Figure 16. A photograph of the Evaluation Board is shown in Figure 17. Component values for the SE2433T Evaluation Board are listed in the Bill of Materials (BOM) in Table 8.

Circuit Design Considerations

The following design considerations are general in nature and must be followed regardless of final use or configuration:

- Paths to ground should be made as short as possible.
- The ground pad of the SE2433T has special electrical and thermal grounding requirements. This pad is the main thermal conduit for heat dissipation. Since the circuit board acts as the heat sink, it must shunt as much heat as possible from the device.

Therefore, design the connection to the ground pad to dissipate the maximum wattage produced by the circuit board. Multiple vias to the grounding layer are required.

NOTE: A poor connection between the ground pad and ground increases junction temperature (T_J), which reduces the life of the device.

Evaluation Board Setup Procedure

1. Connect (J1 and J2) to 50 Ω instruments. Terminate all unused ports (if applicable) with 50 Ω .
2. Connect the supply ground to Pin 7.
3. Connect 3.0 V to Pins 1, 3, and 6 of J3.
4. Apply an RF signal to connector J1 (RF_IN) to monitor the 2.4 GHz amplifier performance. Monitor the output power on connector J2 (RF_OUT).

CAUTION: Care should be taken not to overdrive the amplifier by applying too much RF on the input. A suitable starting input power for the device is -20 dBm.

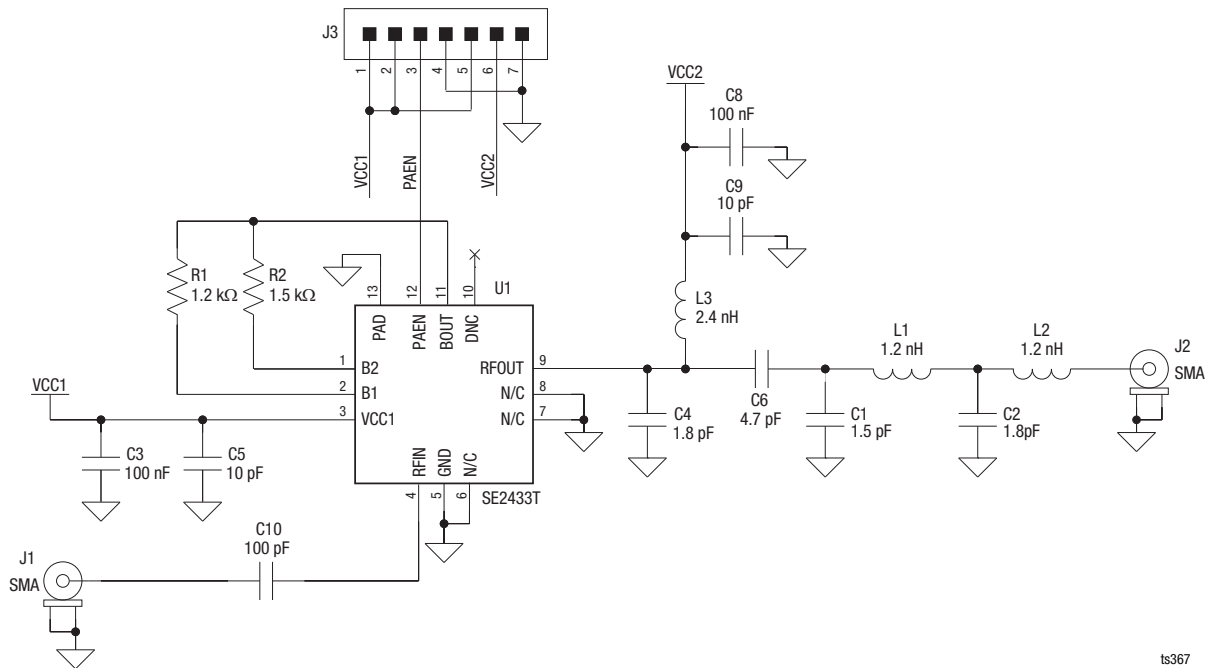
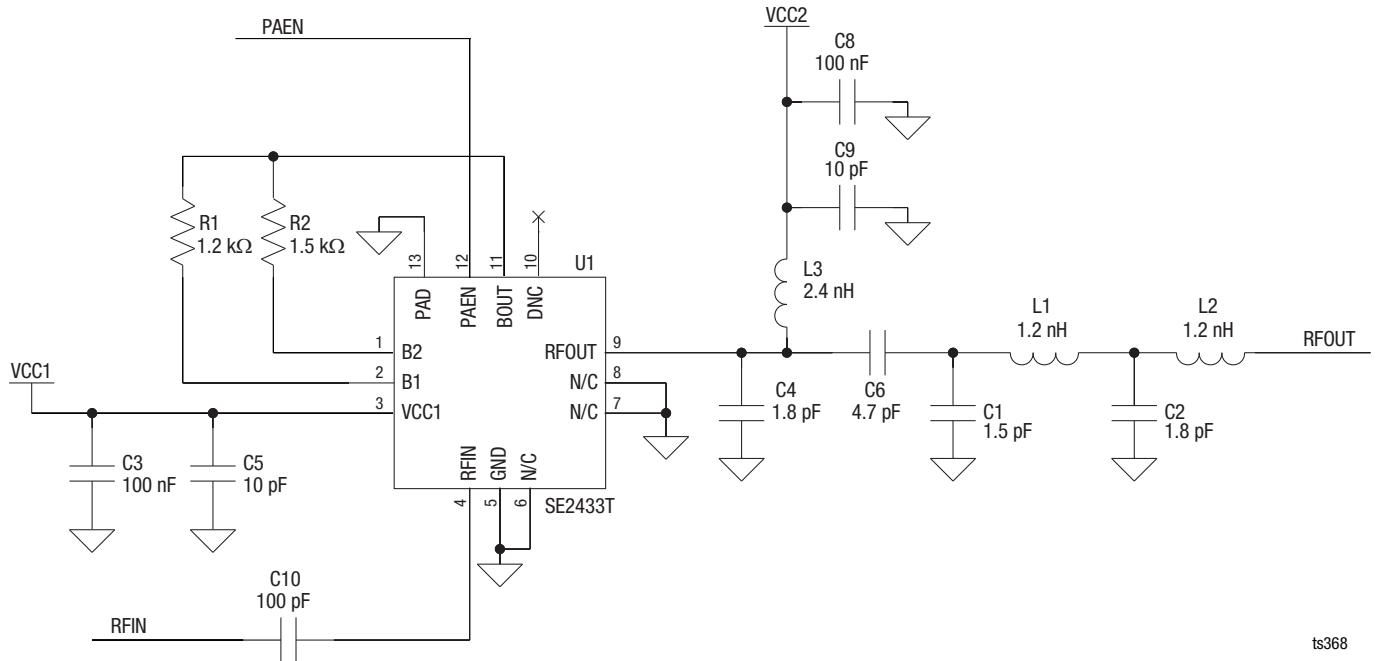

Figure 15. SE2433T Evaluation Board Schematic



ts368

Figure 16. SE2433T Reference Design Schematic

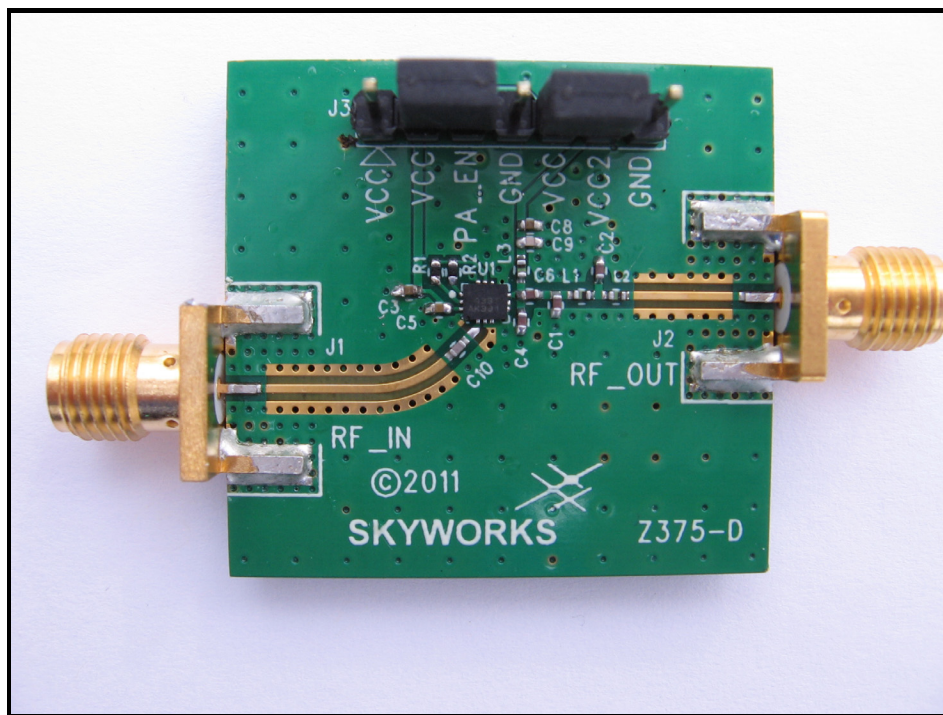

Figure 17. SE2433T Evaluation Board

Table 8. SE2433T Evaluation Board Bill of Materials

Component	Value	Manufacturer	Mfr Part Number	Package	Description
C1	1.5 pF	Murata	GRM1555C1H1R5CZ01	0402	Multilayer ceramic
C2, C8	100 nF	Murata	GRM1555R71C104KA88D	0402	Multilayer ceramic
C4, C2	1.8 pF	Murata	GRM1555C1H1R8CZ01	0402	Multilayer ceramic
C5, C9	10 pF	Murata	GRM1555C1H100JZ01	0402	Multilayer ceramic
C6	4.7 pF	Murata	GRM1555C1H4R7CZ01	0402	Multilayer ceramic
C10	100 pF	Murata	GRM1555C1H101JZ01	0402	Multilayer ceramic
J1, J2	SMA	Johnson Components	142-0701-851	End launch	SMA end launch straight jack receptacle – tab contact
J3	7X1	Samtec	TSW-107-07-G-S	100 mil	
L1, L2	1.2 nH	Murata	LQG15HN1N2S02D	0402	High-frequency multilayer
L3	2.4 nH	Murata	LQG15HN2N4S02D	0402	High-frequency multilayer
R1	1.2 k Ω	Panasonic	ERJ2GEJ122	0402	Thick film chip resistor
R2	1.5 k Ω	Panasonic	ERJ2GEJ152	0402	Thick film chip resistor
U1	SE2433T	Skyworks	SE2433T	QFN 2X2.5–12	802.15.4 PA

Package Dimensions

The recommended land and solder patterns for the SE2433T are provided in Figure 18. Typical part markings are shown in Figure 19. Package dimensions for the are shown in Figure 20, and tape and reel dimensions are provided in Figure 21.

Package and Handling Information

Instructions on the shipping container label regarding exposure to moisture after the container seal is broken must be followed. Otherwise, problems related to moisture absorption may occur when the part is subjected to high temperature during solder assembly.

The SE2433T is rated to Moisture Sensitivity Level 1 (MSL1) at 260 °C. It can be used for lead or lead-free soldering. For additional information, refer to the Skyworks Application Note, *Solder Reflow Information*, document number 200164.

Care must be taken when attaching this product, whether it is done manually or in a production solder reflow environment. Production quantities of this product are shipped in a standard tape and reel format.

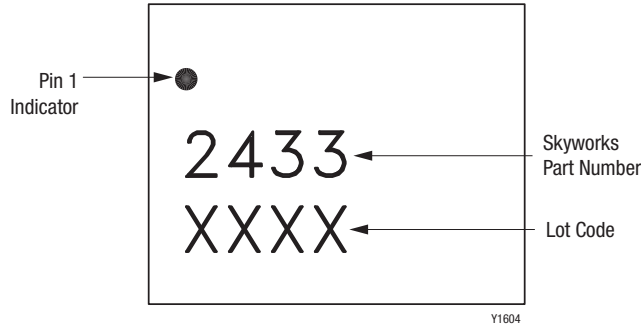
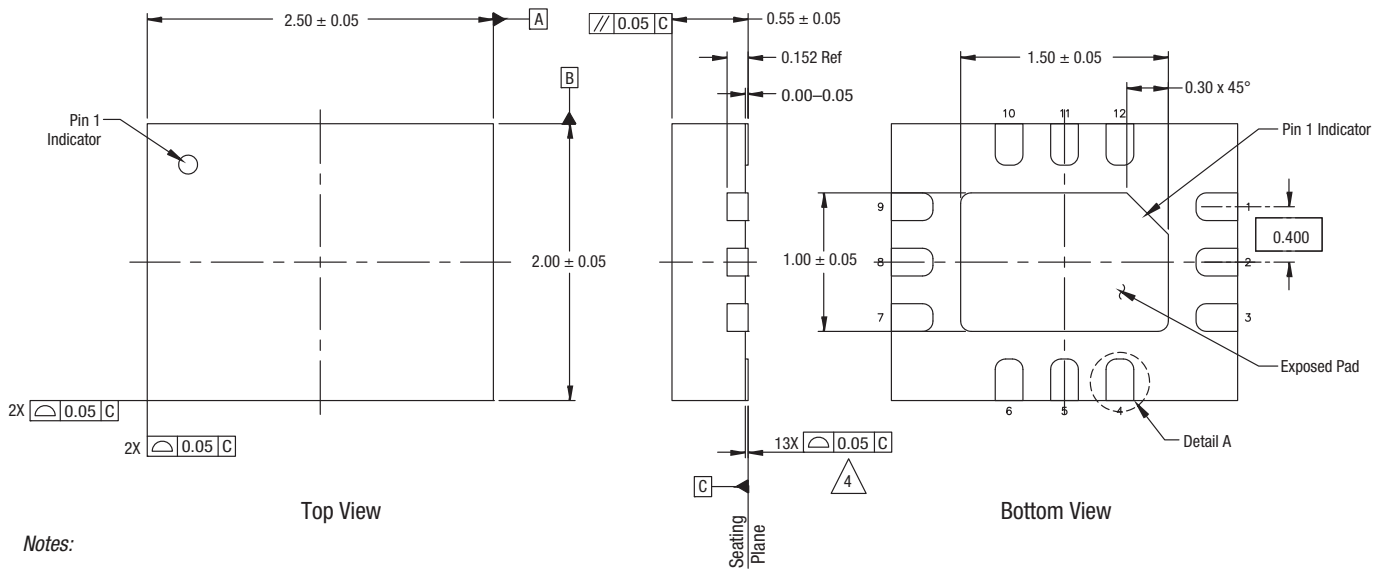

Figure 19. Typical Part Markings (Top View)



Notes:

1. All measurements are in millimeters.
2. Dimensions and tolerances according to ASME Y14.5M-2009.
3. Unless otherwise specified, the following values apply:
 Decimal Tolerance: Angular Tolerance:
 X.X (1 place) ± 0.1 mm ±1/2°
 X.XX (2 places) ± 0.05 mm
 X.XXX (3 places) ± 0.025 mm
4. Coplanarity applies to the terminals as well as all other bottom surface metallization.
5. Dimension applies to metallized terminal. If terminal tip has a radius, dimension should not be measured in that radius area.
6. Unless specified, dimensions are symmetrical about center lines.

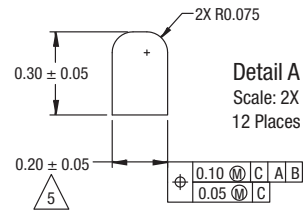
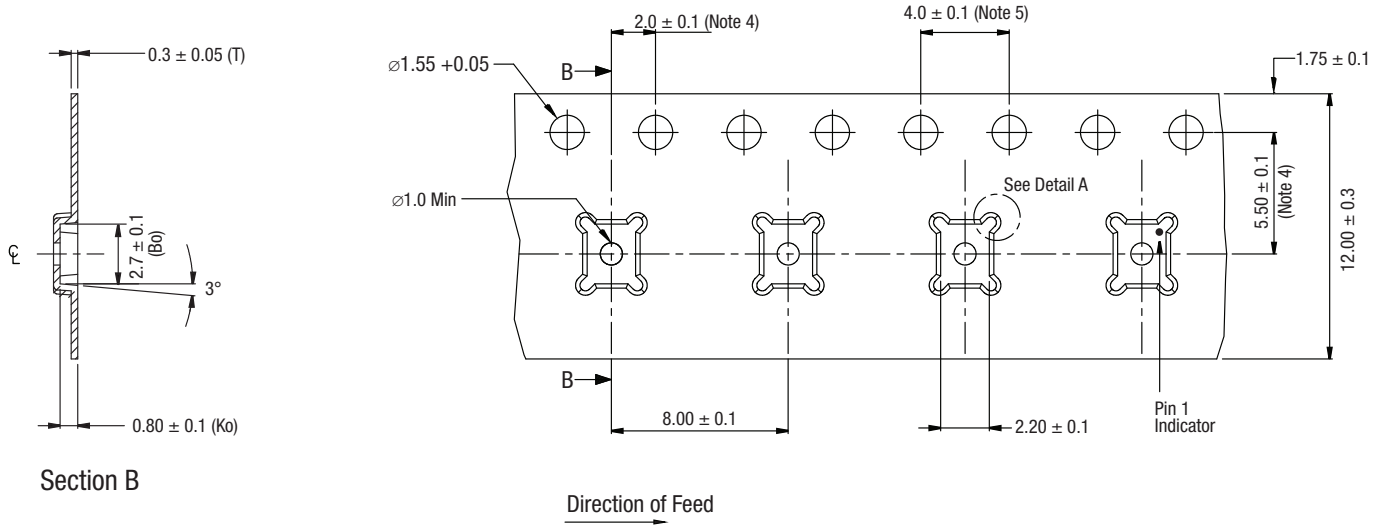

Figure 20. SE2433T Package Dimensions

DATA SHEET • SE2433T: 2.4 GHz POWER AMPLIFIER



Section B

Notes:

1. Carrier tape must meet all requirements of Skyworks GP01-D233 procurement spec for tape and reel shipping.
2. Carrier tape: black conductive polystyrene.
3. Cover tape: transparent conductive material.
4. Measured from center line of sprocket hole to center line of pocket.
5. Ten-sprocket hole pitch cumulative tolerance: ±0.20 mm.
6. All measurements are in millimeters.

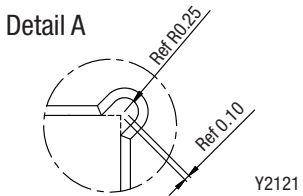

Figure 21. SE2433T Tape and Reel Dimensions

Ordering Information

Model Name	Manufacturing Part Number	Evaluation Board Part Number
SE2433T: 2.4 GHz Power Amplifier	SE2433T-R	SE2433T-EK1

Copyright © 2013-2015 Skyworks Solutions, Inc. All Rights Reserved.

Information in this document is provided in connection with Skyworks Solutions, Inc. ("Skyworks") products or services. These materials, including the information contained herein, are provided by Skyworks as a service to its customers and may be used for informational purposes only by the customer. Skyworks assumes no responsibility for errors or omissions in these materials or the information contained herein. Skyworks may change its documentation, products, services, specifications or product descriptions at any time, without notice. Skyworks makes no commitment to update the materials or information and shall have no responsibility whatsoever for conflicts, incompatibilities, or other difficulties arising from any future changes.

No license, whether express, implied, by estoppel or otherwise, is granted to any intellectual property rights by this document. Skyworks assumes no liability for any materials, products or information provided hereunder, including the sale, distribution, reproduction or use of Skyworks products, information or materials, except as may be provided in Skyworks Terms and Conditions of Sale.

THE MATERIALS, PRODUCTS AND INFORMATION ARE PROVIDED "AS IS" WITHOUT WARRANTY OF ANY KIND, WHETHER EXPRESS, IMPLIED, STATUTORY, OR OTHERWISE, INCLUDING FITNESS FOR A PARTICULAR PURPOSE OR USE, MERCHANTABILITY, PERFORMANCE, QUALITY OR NON-INFRINGEMENT OF ANY INTELLECTUAL PROPERTY RIGHT; ALL SUCH WARRANTIES ARE HEREBY EXPRESSLY DISCLAIMED. SKYWORKS DOES NOT WARRANT THE ACCURACY OR COMPLETENESS OF THE INFORMATION, TEXT, GRAPHICS OR OTHER ITEMS CONTAINED WITHIN THESE MATERIALS. SKYWORKS SHALL NOT BE LIABLE FOR ANY DAMAGES, INCLUDING BUT NOT LIMITED TO ANY SPECIAL, INDIRECT, INCIDENTAL, STATUTORY, OR CONSEQUENTIAL DAMAGES, INCLUDING WITHOUT LIMITATION, LOST REVENUES OR LOST PROFITS THAT MAY RESULT FROM THE USE OF THE MATERIALS OR INFORMATION, WHETHER OR NOT THE RECIPIENT OF MATERIALS HAS BEEN ADVISED OF THE POSSIBILITY OF SUCH DAMAGE.

Skyworks products are not intended for use in medical, lifesaving or life-sustaining applications, or other equipment in which the failure of the Skyworks products could lead to personal injury, death, physical or environmental damage. Skyworks customers using or selling Skyworks products for use in such applications do so at their own risk and agree to fully indemnify Skyworks for any damages resulting from such improper use or sale.

Customers are responsible for their products and applications using Skyworks products, which may deviate from published specifications as a result of design defects, errors, or operation of products outside of published parameters or design specifications. Customers should include design and operating safeguards to minimize these and other risks. Skyworks assumes no liability for applications assistance, customer product design, or damage to any equipment resulting from the use of Skyworks products outside of stated published specifications or parameters.

Skyworks and the Skyworks symbol are trademarks or registered trademarks of Skyworks Solutions, Inc., in the United States and other countries. Third-party brands and names are for identification purposes only, and are the property of their respective owners. Additional information, including relevant terms and conditions, posted at www.skyworksinc.com, are incorporated by reference.