



Chipsmall Limited consists of a professional team with an average of over 10 year of expertise in the distribution of electronic components. Based in Hongkong, we have already established firm and mutual-benefit business relationships with customers from,Europe,America and south Asia,supplying obsolete and hard-to-find components to meet their specific needs.

With the principle of “Quality Parts,Customers Priority,Honest Operation,and Considerate Service”,our business mainly focus on the distribution of electronic components. Line cards we deal with include Microchip,ALPS,ROHM,Xilinx,Pulse,ON,Everlight and Freescale. Main products comprise IC,Modules,Potentiometer,IC Socket,Relay,Connector.Our parts cover such applications as commercial,industrial, and automotives areas.

We are looking forward to setting up business relationship with you and hope to provide you with the best service and solution. Let us make a better world for our industry!



## Contact us

Tel: +86-755-8981 8866 Fax: +86-755-8427 6832

Email & Skype: info@chipsmall.com Web: www.chipsmall.com

Address: A1208, Overseas Decoration Building, #122 Zhenhua RD., Futian, Shenzhen, China





## Micro Modules

(Substrates with Built-in ICs, Products Utilizing with SESUB)

Bluetooth V4.0 Smart Single Mode Module

# SESUB-PAN-T2541

---

## Micro Modules

### (Substrates with Built-in ICs, Products Utilizing with SESUB)

#### Bluetooth V4.0 Smart Single Mode Module

# Overview of SESUB-PAN-T2541

## FEATURES

- Micro size (4.6×5.6×1.0mm) ideal for wearable devices.
- Communicable with Bluetooth® Smart Ready compatible devices.
- Separate antenna type that provides more flexibility for product design.

## APPLICATION

- Health care, sports & fitness devices  
(physical activity monitor, thermometer, blood pressure monitor, blood oxygen monitor, blood sugar monitor, heart rate monitor, etc.)
- Wearable computers  
(bracelet type, watch type, ring type, glass type, shoe, hat, shirt, etc.)
- Home & entertainment devices  
(remote control, sensor tag, toy, lighting apparatus, etc.)
- PC accessories  
(mouse, keyboard, stylus pen, presentation pointer, etc.)

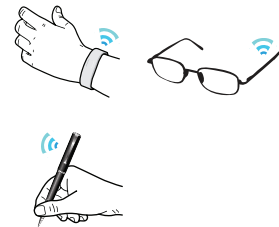

## BLOCK DIAGRAM

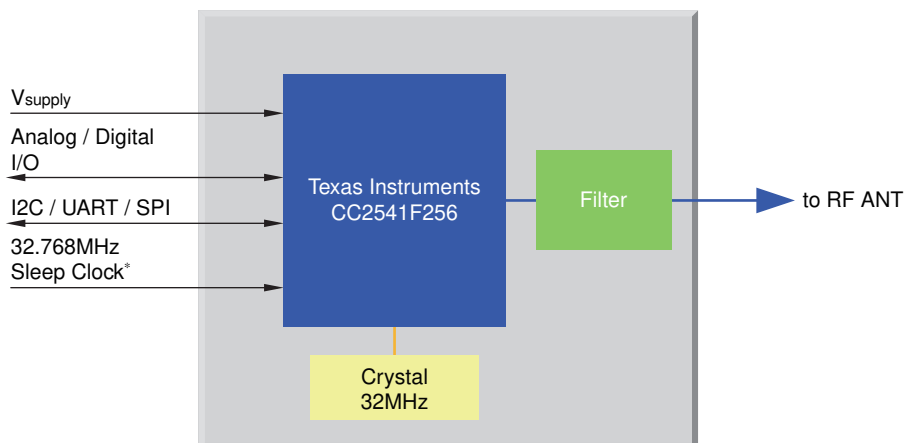

- Bluetooth® and Bluetooth® Low Energy are the standards established by Bluetooth Special Interest Group (SIG).

# SESUB-PAN-T2541

## SHAPE & DIMENSIONS

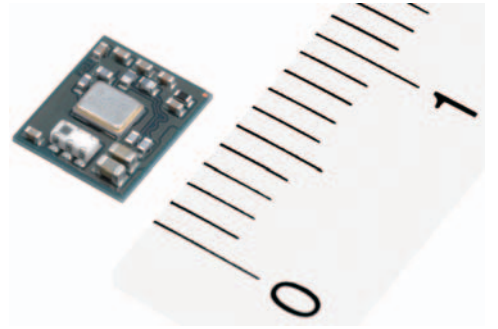
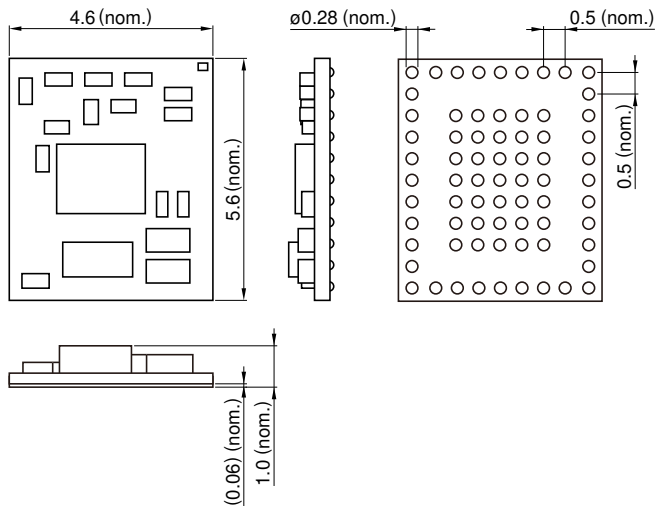

## ELECTRICAL CHARACTERISTICS

### CHARACTERISTICS SPECIFICATION TABLE

Communication standards	2.4GHz Bluetooth® V4.0 low energy
Wireless output power (dBm)typ.	0
Communication range (m)*	10
Interface	UART/SPI/I2C/GPIO/ADC







\* Line-of-sight distances. Depending on antenna properties.



# SESUB-PAN-T2541

## MODULE TERMINAL

1	2	3	4	5	6	7	8	9
GND	P2_1	P2_0	VDO	VDA_1	VDA_2	GND	RST_N	GND
36								10
P2_2								P0_0
35								11
GND		GND	GND	GND	GND	GND		P0_1
34								12
P2_4/32k		GND	GND	GND	GND	GND		P0_2
33								13
P2_3/32k		GND	GND	GND	GND	GND		P0_3
32								14
P1_7		GND	GND	GND	GND	GND		P0_4
31								15
P1_6		GND	GND	GND	GND	GND		P0_5
30								16
P1_1		GND	GND	GND	GND	GND		P0_6
29								17
P1_2		GND	GND	GND	GND	GND		P0_7
28								18
P1_3								P1_0
27	26	25	24	23	22	21	20	19
GND	SCL	SDA	P1_4	P1_5	GND	2G_RF	GND	GND

RF	
POWER	
Clock	
I/O	
Cont	
GND	

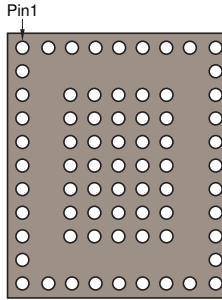

Module Bottom View

## EVALUATION BOARD

Based on the IC manufacturer-provided evaluation environment (TDK part number: SP13801)

- The product is used by connecting to the IC evaluation kits of IC manufacturers.
- All software development environments and programming tools are provided by IC manufacturers.
- Various development materials of IC manufacturers are available as they are, which enables smooth development of products.
- We also offer evaluation kits which enables to evaluate product functions easily. (TDK part number: SP13808)

\* For more details, please contact us.

Equipped with a program writing terminal

A chip antenna on the evaluation board

Equipped with a land pattern for a crystal unit for generating a sleep clock

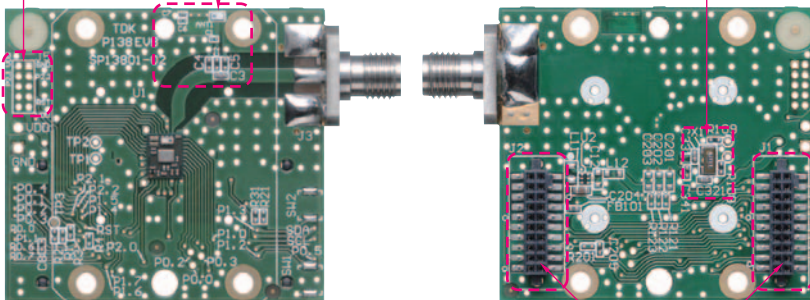

Connectors to evaluation boards of the IC manufacturers

 Please be sure to request delivery specifications that provide further details on the features and specifications of the products for proper and safe use. Please note that the contents may change without any prior notice due to reasons such as upgrading. For product inquiries: SESUB\_Support@tdk.co.jp