



Chipsmall Limited consists of a professional team with an average of over 10 year of expertise in the distribution of electronic components. Based in Hongkong, we have already established firm and mutual-benefit business relationships with customers from,Europe,America and south Asia,supplying obsolete and hard-to-find components to meet their specific needs.

With the principle of “Quality Parts,Customers Priority,Honest Operation,and Considerate Service”,our business mainly focus on the distribution of electronic components. Line cards we deal with include Microchip,ALPS,ROHM,Xilinx,Pulse,ON,Everlight and Freescale. Main products comprise IC,Modules,Potentiometer,IC Socket,Relay,Connector.Our parts cover such applications as commercial,industrial, and automotives areas.

We are looking forward to setting up business relationship with you and hope to provide you with the best service and solution. Let us make a better world for our industry!



Contact us

Tel: +86-755-8981 8866 Fax: +86-755-8427 6832

Email & Skype: info@chipsmall.com Web: www.chipsmall.com

Address: A1208, Overseas Decoration Building, #122 Zhenhua RD., Futian, Shenzhen, China





Conforming to Machine
& EMC Directive



Certified



Approved Listing

Conforming to
OSHA / ANSI



Certified
(SF4B-□<V2> only)



(SF4B-□<03<V2> only)



Conforming to 4584
(Excluding SF4B-□<03<V2>)

Protection structure IP67

New version with improved environmental
resistance performance

Robust type SF4B-□G□<V2>

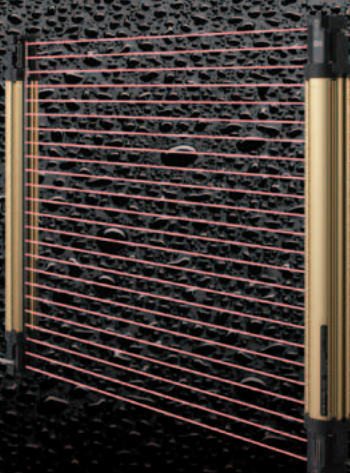
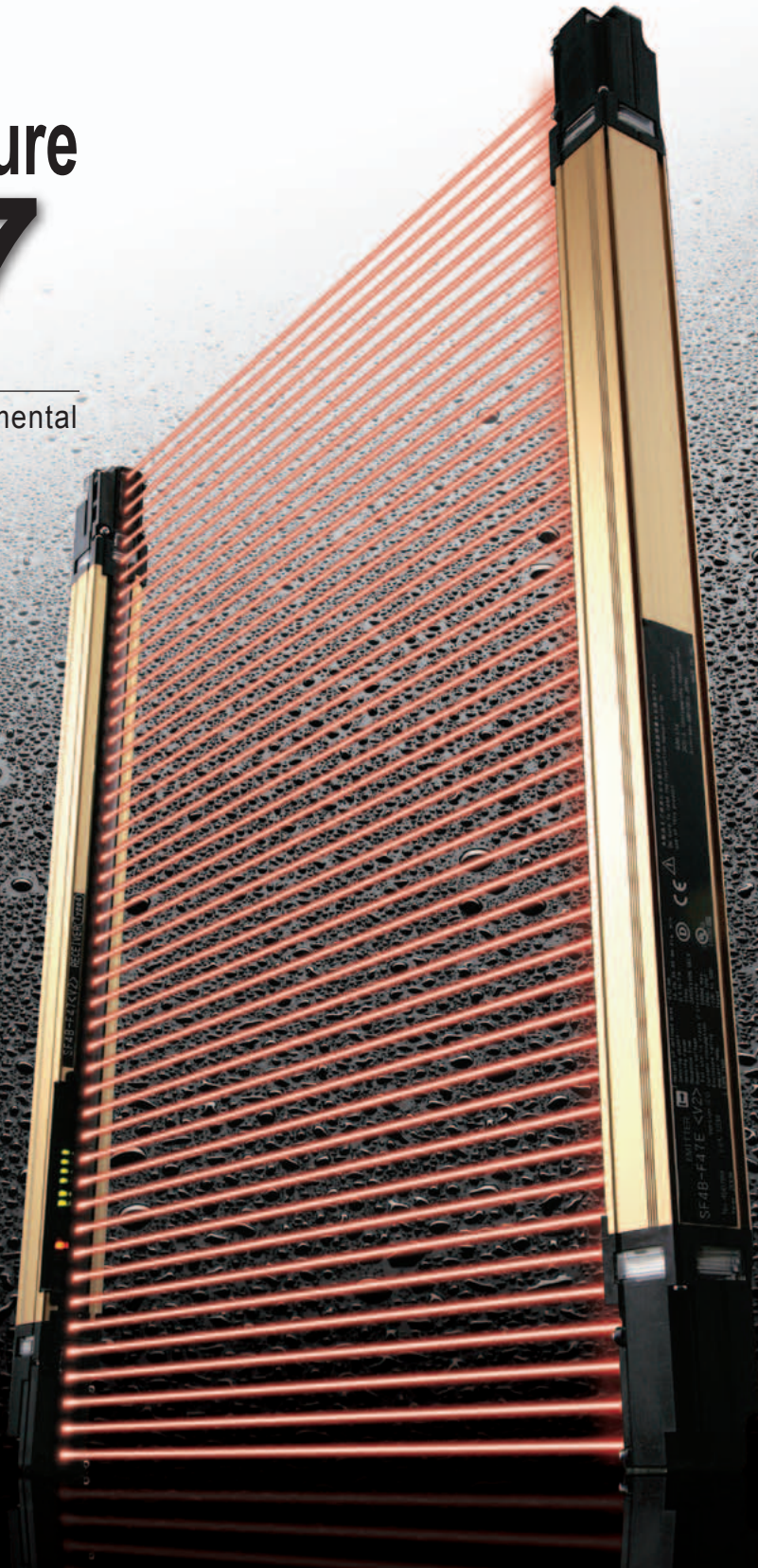



Advanced light curtains at the forefront of the industry

Protection structure IP67 in a very compact size

Improved environmental resistance performance and easier operability New structure

A seamless structure with minimal joints has now been developed. The inner unit is protected by a cylindrical inner case. Seams on the unit and lens surfaces have been greatly reduced so that particles such as oil mists and dust are prevented from penetrating the case. Thus, the environmental resistance performance could be raised.

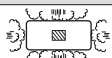
SF4B series has passed the tests of IP65 and IP67 as specified by IEC / JIS standards. (Ver.2 only)

IEC / JIS	Description	
IP65	No harmful effect from direct water jet from any direction	
IP67	No water penetration from immersion in water under specified conditions	

* Refer to each standard for details of test conditions.

Inner case

Cylindrical inner case protects the internal unit.

This new structure does not use adhesive or double-sided tape on the joints like the previous models. There is no need to worry about water immersion or corrosion such as a coolant causing the adhesive to strip off.



Error details can be understood at a glance

Equipped with a digital error indicator

The system constantly checks the light curtain for problems such as incorrect cable wiring, disconnection, short-circuits, internal circuit problems, and incoming light problems. Details of any electrical problems such as at equipment startup will appear on the digital display. It is no longer necessary to count the number of times the LED blinks, making the system much more convenient.



Angle of view is wider and indicators are even more visible

Error number notification means smooth support via telephone



Normal operation

Error occurred

Digital error indicator



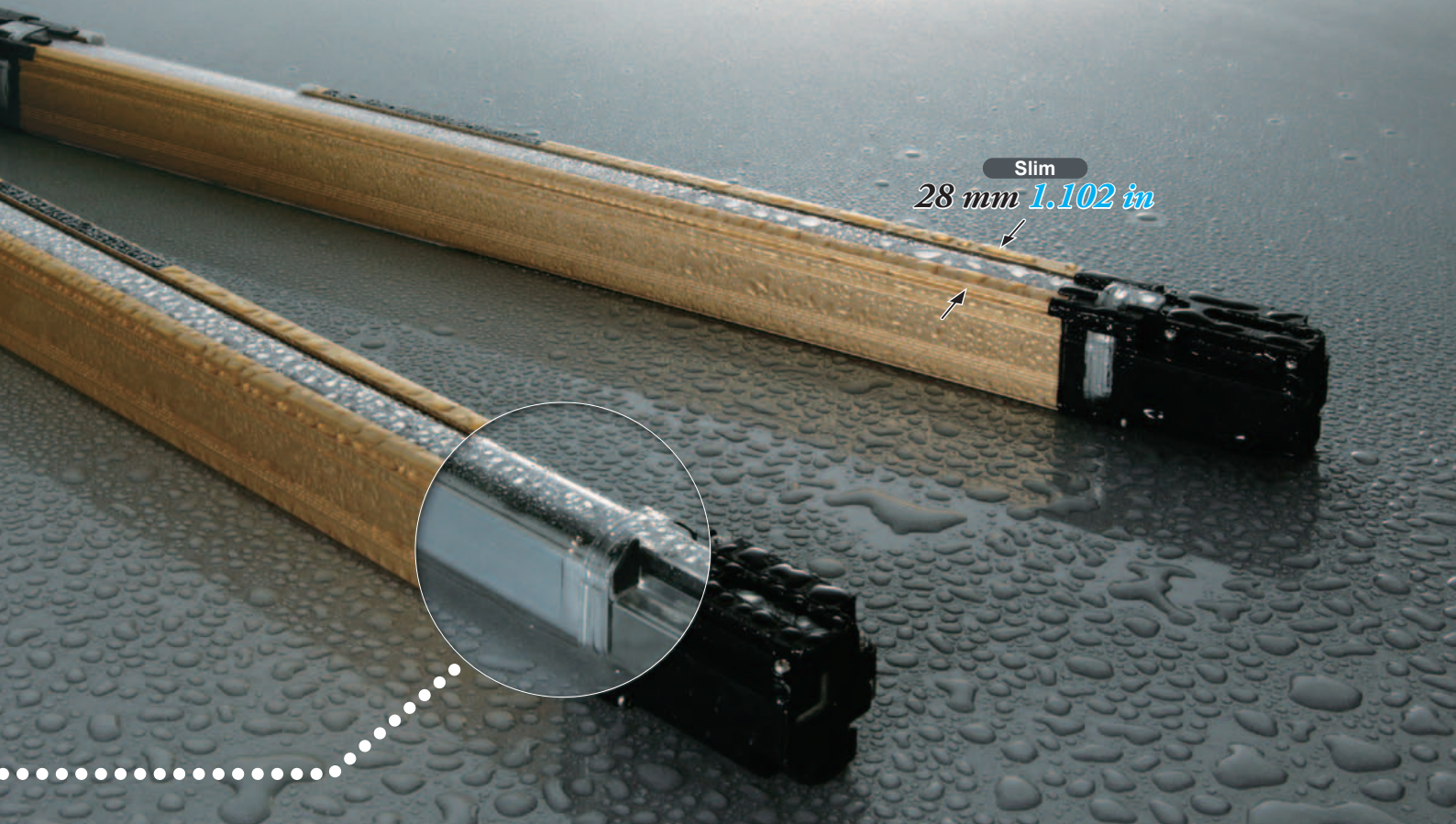

Unified response time for all models

A fast response time of 14 ms has been achieved regardless of the number of beam channels, the beam axis pitches and the number of units connected in series. This reduces calculation work required for the safety distance.

14 ms even in case of 3 units connected in series!

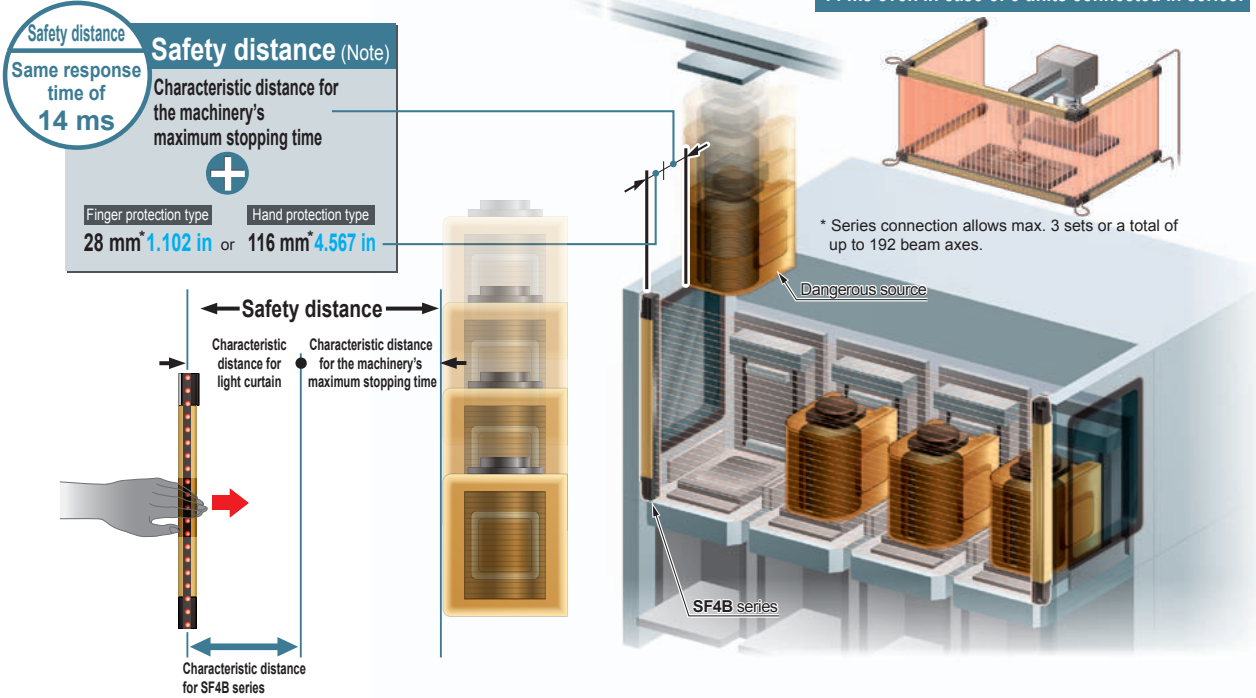

* This is the characteristic safety distance for the light curtain as defined by ISO 13855.
Note: Calculate the safety distance based on the distance depending on the light curtain and the distance depending on the maximum halting time of machinery. For more details, refer to p.31~. Install the light curtain according to the relevant standards of the region where the light curtain is used.

A universal design that can be used anywhere in the world

In Europe, America and Japan
PNP output and NPN output
in a single model!

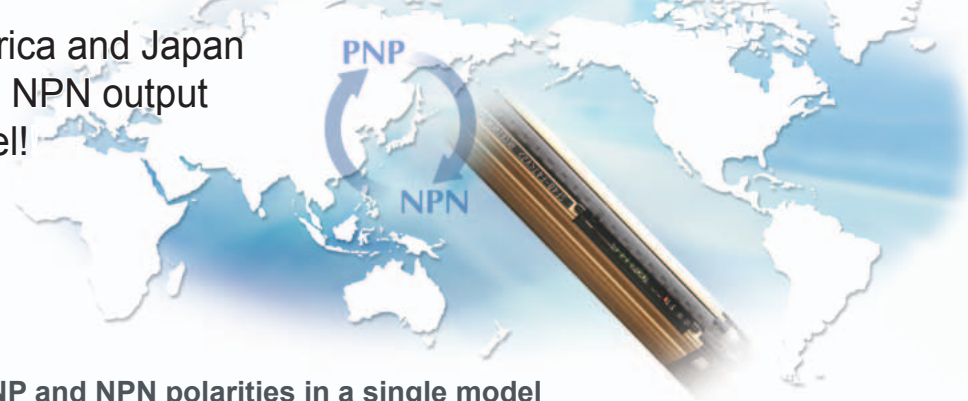

Supports both PNP and NPN polarities in a single model

The **SF4B** series combines PNP transistor output and NPN transistor output in a single model. Overseas equipment that uses PNP, replacement with NPN sensors, factories that are positively grounded, and transfer of equipment overseas are all situations where the control circuits for a single model are suitable for use worldwide.

■ Polarity can be changed easily by changing wiring

When the output polarity setting wire (shielded) is connected to 0 V, PNP output is selected, and when it is connected to 24 V, it switches to NPN output.

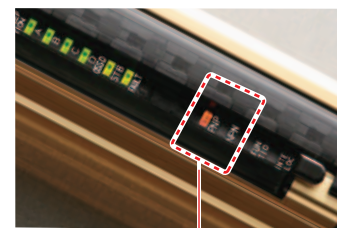
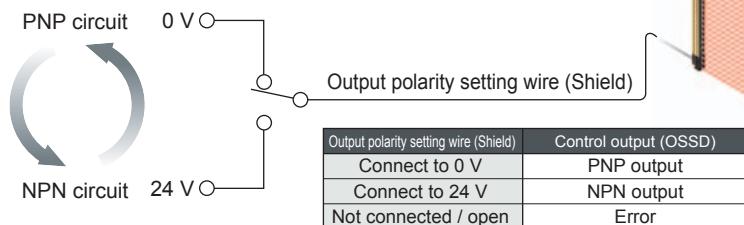

PNP / NPN polarity indicator
Either PNP or NPN side lights depending on which is selected.

Global support for the safety of press machines or shear (paper cutting) machines

Can be widely used for press machines and other types of equipment from Japan, Europe, North America, South Korea, and China.

●: Available

Type	Model No.	Machinery Directive	EMC Directive	UL Certified	Japanese Press Machine Support	Japanese Shear (Paper Cutter) Support	S-mark certification	Korean Press / Cutting Machine	Chinese GB Compatibility
Light curtains	SF4B-□<V2>	●	●	●	●	—	●	—	●
	SF4B-□G<V2>	●	●	●	●	—	—	—	●
	SF4B-A□-01<V2>	—	—	—	● (No.TA523)	● (No.TA521)	—	—	●
	SF4B-H□-01<V2>	●	●	●	● (No.TA524)	● (No.TA522)	—	—	●
	SF4B-H□G-01<V2>	—	—	—	—	—	—	—	—
	SF4B-F□-01<V2>	●	●	●	—	—	—	● (No.09-AV4BI-0001-0009)	—
Control units	SF-C11	●	●	●	● (No.TA525) (Note1) ● (No.TA526) (Note2)	—	●	—	—
	SF-C12	●	●	●	—	—	—	—	—
	SF-C13	●	●	●	● (No.TA527) (Note1) ● (No.TA528) (Note2)	—	●	—	—
	SF-C14EX	●	●	●	—	—	—	—	—
	SF-C14EX-01	●	●	●	● (No.TA529) (Note1) ● (No.TA530) (Note2)	—	—	—	—

Notes: 1) In combination with SF4B-A□-01<V2>. (For products produced in or after October 2012)

2) In combination with SF4B-H□-01<V2> / SF4B-H□G-01<V2> / SF4B-F□-01<V2>. (For products produced in or after October 2012)

It is possible to select from among each three types of standard / robust types depending on the worksite

A wide range of variations are available with protective heights of 230 to 1,910 mm 9.055 to 75.197 in (1,270 mm 50.000 in for the finger protection type). Mixing six types in a series connection is also possible.

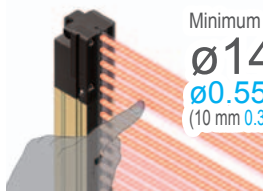
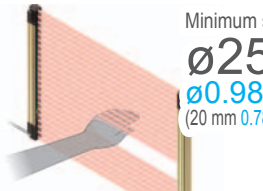
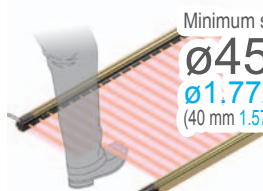
Finger protection type SF4B-F□(G)  Minimum sensing object ø14 mm ø0.551 in (10 mm 0.394 in beam pitch)	Hand protection type SF4B-H□(G)  Minimum sensing object ø25 mm ø0.984 in (20 mm 0.787 in beam pitch)	Arm / foot protection type SF4B-A□(G)  Minimum sensing object ø45 mm ø1.772 in (40 mm 1.575 in beam pitch)
---	---	---

Muting control function is built into light curtain Safety circuits are selectable

A muting control function is provided to increase both safety and productivity

The light curtain is equipped with a muting control function that causes the line to stop only when a person passes through the light curtain, and does not stop the line when an object passes through. The muting sensors and muting lamps can be connected directly to the light curtain so that an exclusive controller is not required for muting. This both reduces costs and increases safety and productivity.

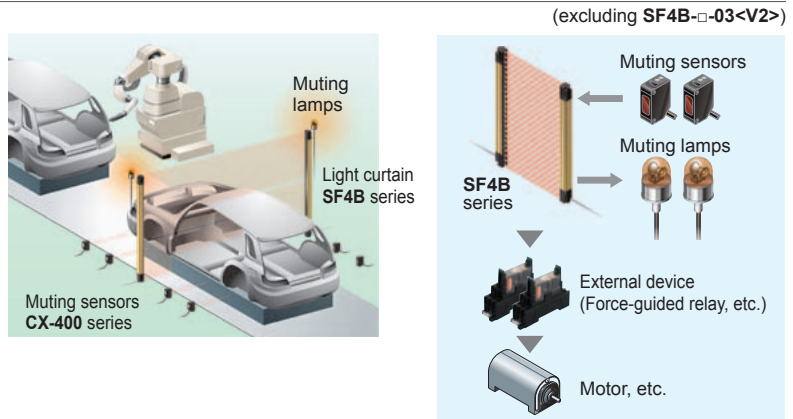

Override function allows the line to be restarted smoothly after it has stopped while muting control was active

In case the power turns off while the light curtain has been interrupted by an object or in case the line stops before the muting conditions have been established (if only one muting sensor has been interrupted), the line can be restarted smoothly without having to remove the object that is interrupting the light curtain.

Example : When power turns off while light curtain was interrupted (excluding SF4B-□-03<V2>)

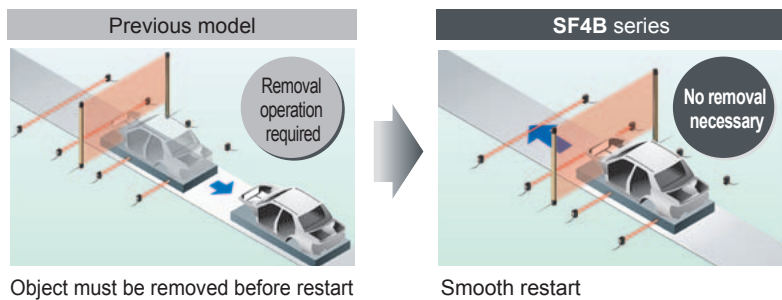

Equipped with a safety circuit that does not require an exclusive safety relay unit

The light curtain has a built-in external device monitoring function (such as for monitoring whether relays have fused) and an interlock function. The safety circuit is built without safety relay unit and size reduction of a control board is achieved, which contributes to cost reduction.

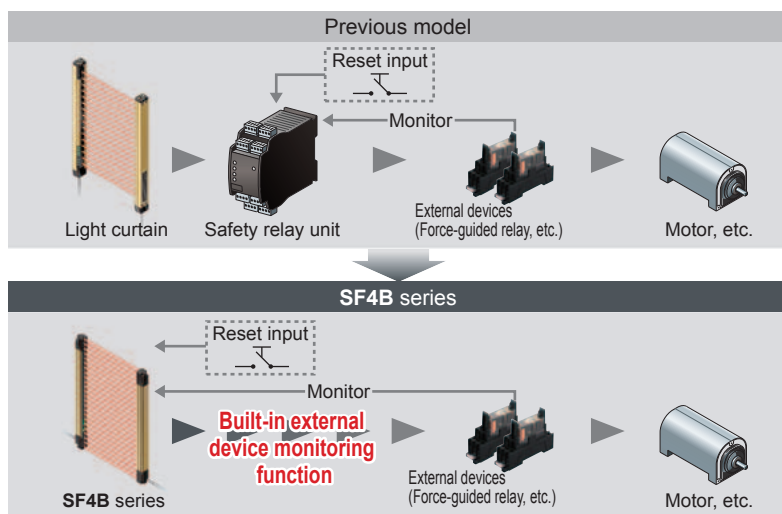

Recommended safety relay

Panasonic Corporation
SF relay slim type

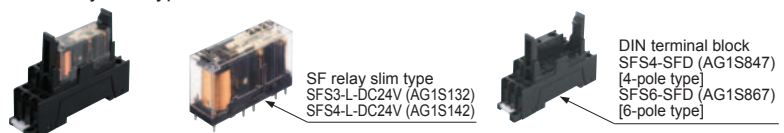

Note: Contact Panasonic Corporation for details on the recommended products.

A commitment to design that is easy to use

Beam-axis alignment indicators show the incident light position at a glance

Beam-axis alignment indicators display the beam channels of the light curtain in four blocks. When the beam channel at the bottommost channel (or topmost channel), which is used as a reference for beam-axis alignments, is correctly aligned, the LED blinks red. After this, each block lights red as the beam axes successively become aligned. When all channel beam axes are aligned, all LEDs light green. The display also has an additional stability indicator (STB) so that setup can be carried out with greater stability.

Beam axes are displayed in 4 blocks	The bottommost beam axis is aligned	The beam axes of the two lower blocks are aligned	All beam axes are aligned
	<p>The bottommost LED 'D' is blinking red</p>	<p>The two bottom LEDs 'C, D' light up in red</p>	<p>All LEDs 'A to D' light up in green</p> <p>Furthermore, STB display allows the most stable incident light status* to be confirmed.</p> <p>* 140 % or more incident light intensity of control output operation level</p>

Laser alignment tool for easy installation

The tool performs beam-axis alignment using a laser beam spot. As the tool is battery-operated, it is possible to perform beam-axis alignment before supplying power to the equipment.

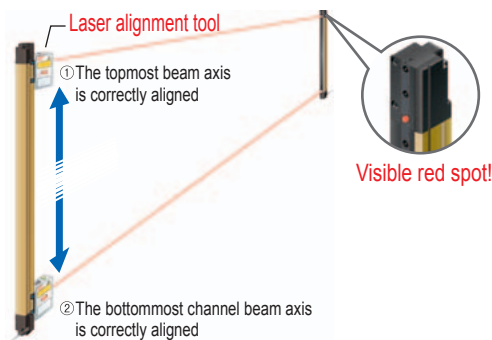

Greatly improved ease of installation (excluding SF4B-G□)

The hexagon-socket head bolts used for aligning the beam axis can be accessed from the front of the light curtain. Beam adjustment can be carried out easily while turning the bolts. Also, the beam-axis alignment part is directly and firmly fixed with M5 bolts so that beam axes misalignment can be prevented.

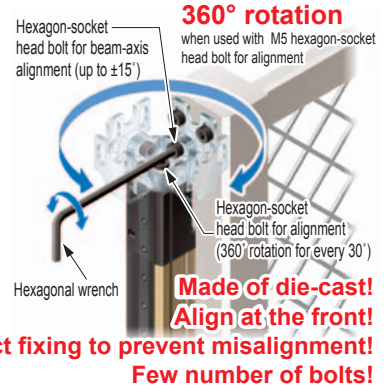

Easy to distinguish receiver and emitter

Emitter is gray, receiver is black. Whether during startup or maintenance, troubles due to incorrect wiring or false recognition can be greatly reduced. Moreover, the model No. can be checked at the front face of the light curtain.

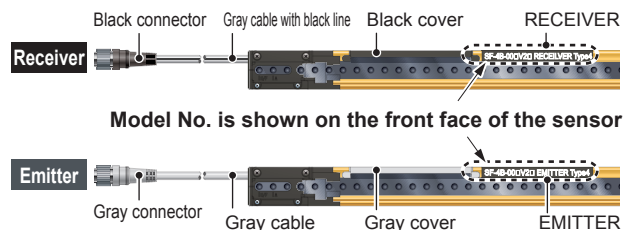

Mutual interference is reduced without needing interference prevention lines

The light curtain is equipped with the ELCA (Extraneous Light Check & Avoid) function. Because it automatically shifts the scan timing of the light curtain in order to avoid interference, it is not necessary to wire interference prevention lines between machineries.

Reducing the number of malfunctions caused by extraneous light

Double scanning method and retry processing are two new functions exclusive to our company, which successfully eliminate the effects of momentary extraneous light from peripheral equipment. The reduction in operating errors caused by extraneous light reduces frequent stopping of machinery.

Options exclusive for light curtain are available for an easy construction of safety circuit

Handy-controller SFB-HC* that enables the user to select a variety of settings **SFB-HC**

Separate muting control function for each beam channel

The handy-controller **SFB-HC*** (optional) can be used to carry out muting control for specified beam axes only. Because individual beam axis can be specified to suit the object, separate guards to prevent entry do not need to be set up.

While muting control is active (line operating)

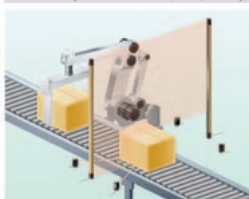

Line stopped



For example, depending on the height of the object, the muting function can be activated for 10 beam channels starting from the bottom, so that if the 11th or subsequent beam channels are interrupted, it is judged that a person has entered the area and the line stops.

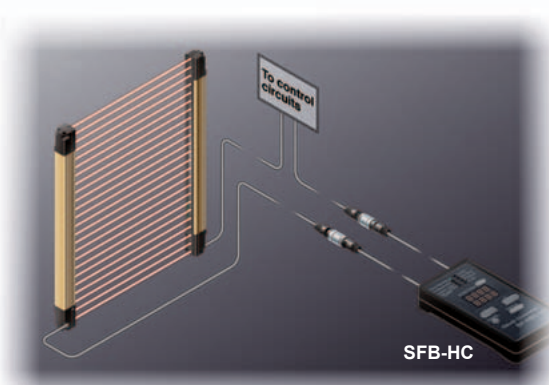

* A handy-controller cannot be used with the **SF4B-□-01<V2>**, **SF4B-H□G-01<V2>**, **SF4B-□-03<V2>** and the **SF-C14EX-01**.

Specific beam axes can be deactivated The SF4B series incorporates a fixed blanking function.

The **SF4B** series is equipped with a fixed blanking function which allows specific beam channels to be selectively interrupted without causing the control output (OSSD) to output the OFF signal. This function is convenient for use with applications in which certain fixed obstacles tend to block specific beam channels. Furthermore, this function provides greater safety as the control output (OSSD) will automatically output the OFF signal if the fixed obstacles are subsequently removed from the sensing area.

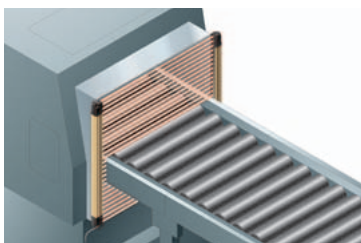

A variable number of beam axes can be deactivated The SF4B series incorporates a floating blanking function.

1, 2 or 3 non-specified beam channels can be deactivated. If the number of beam channels that are blocked is less than or equal to the set number of beam channels, then the control output (OSSD) will not output the OFF signal. This function is useful when the positions of obstacles within the sensing area must be changed during object rearrangement, or when an object passes through the light curtain's sensing area.

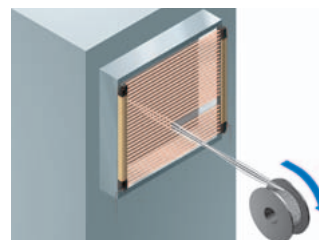

Note: When the floating blanking function is used, the acceptable size for the minimum sensing object changes. Refer to "**PRECAUTIONS FOR PROPER USE**" (p.30) for details.

Selectable configuration for auxiliary output

Mode No.	Description
0	Negative logic of the control output (OSSD 1, OSSD 2) (factory setting)
1	Positive logic of the control output (OSSD 1, OSSD 2)
2	For emission: output ON, For non-emission: output OFF
3	For emission: output OFF, For non-emission: output ON
4	For unstable incident beam: OFF (Note 1)
5	For unstable incident beam: ON (Note 1)
6	For muting: ON
7	For muting: OFF
8	For beam received: ON, For beam interrupted: OFF (Note 2)
9	For beam received: OFF, For beam interrupted: ON (Note 2)

Notes: 1) The output cannot be used while the fixed blanking function, floating blanking function or the muting function is activated.
2) This device outputs the beam received / interrupted state at the detectable area regardless of fixed blanking function, floating blanking function, and muting function.

A variety of other functions can be selected

Emission intensity control function

This function reduces the amount of emitting light. The two modes, normal mode and short mode, can be selected (factory setting: normal mode).

Monitoring function

This function allows the user to confirm the details of each light curtain setting.

Protection function

A password protection can be used to avoid unauthorized changes of the settings (factory setting: no password protection).

Copy function

Setting details can be copied to other light curtains. This is helpful if you need the same settings on different devices.

Muting lamp diagnosis setting

When the muting lamp diagnosis is disabled, the muting function will continue to operate even if the lamp is blown. Refer to the **SF4B<V2>** manual for details.

Resistant to impact, less damage to workpiece

Robust type SF4B-□G□<V2>

Thick and robust housing resistant to impact

The SF4B-□G□<V2> light curtain is enclosed in a 5 mm (0.197 in) thick robust metal case, protecting the workpiece from various types of impact, such as collision or being stepped on.

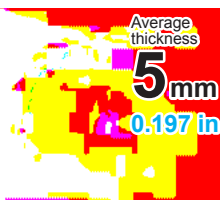
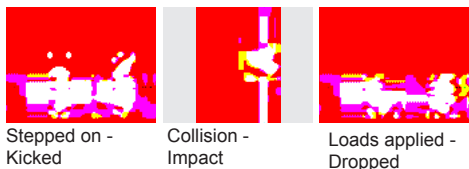

Front protection cover

The front protection cover protects the sensing surface from welding spatter and reduces damage due to collisions. The beam axis adjuster can be attached without removing the front protection cover.

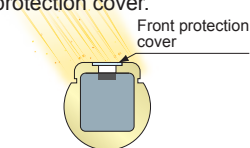

No guard needed

The robust light curtain can be used without an L-shape or U-shape guard, reducing installation and maintenance.

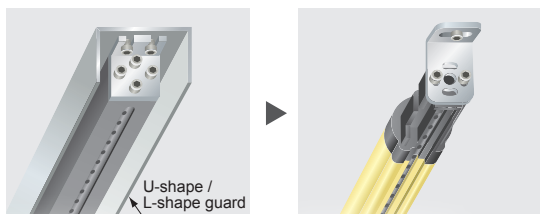

Fully protected sensing surface

The sensing surface is fully protected by narrowing and deepening the exposed area of the sensing surface.

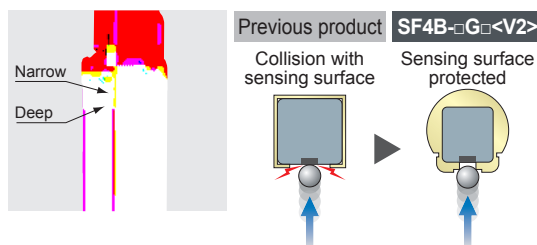

Round design minimizes damage to the workpiece

The case is designed so that shock upon impact is dissipated alleviating potential damage to the workpiece in the event of a collision.

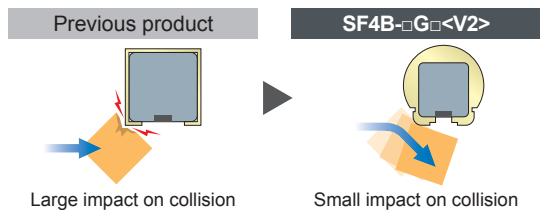

Enables series connection with standard type possible

The mating cable is standard, allowing the robust and standard types to be connected in series.

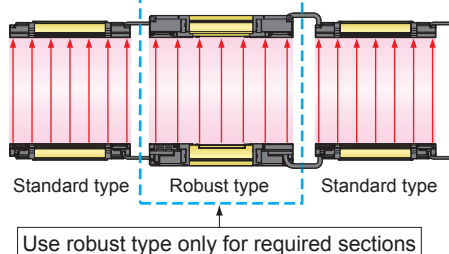

Workpiece not contaminated with paint

The body has an alumite-treated case so that paint does not stick to the workpiece in the event of a collision.

PRODUCT CONFIGURATION



Mounting bracket and mating cable are optional.

Standard components (8-core cable)

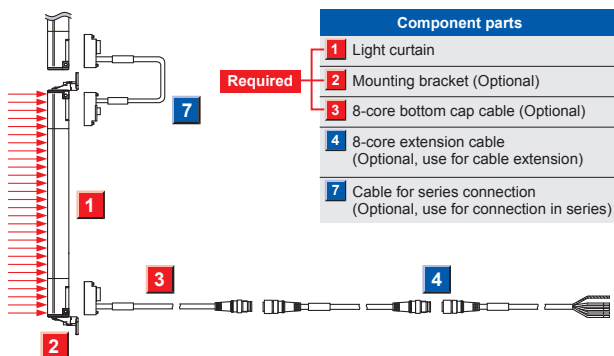

Muting control components (12-core cable, with interference prevention wire)

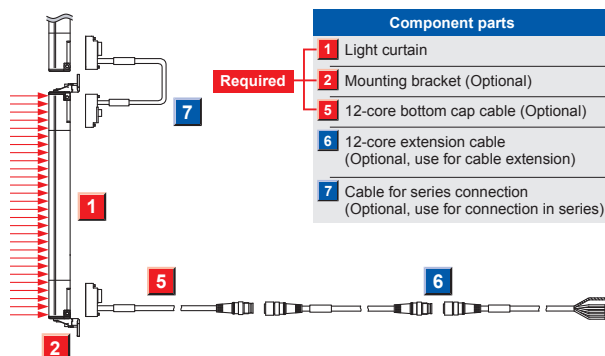

ORDER GUIDE

1 Light curtains Mounting bracket and bottom cap cable are not supplied with the light curtain. Be sure to order them separately.

Type	Appearance	Operating range (Note 1)	Model No. (Note 2)			Number of beam channels	Protective height (mm in)			
			SFB-HC non-compatible	Korean Press compliant (SFB-HC non-compatible)	China Press compliant (GB4584)(Note 3)					
Finger protection type Min. sensing object ϕ 14 mm ϕ 0.551 in (10 mm 0.394 in beam pitch)		0.3 to 7 m 0.984 to 22.966 ft	SF4B-F23<V2>	SF4B-F23-01<V2>	SF4B-F23-03<V2>	23	230	9.055	220	8.661
			SF4B-F31<V2>	SF4B-F31-01<V2>	SF4B-F31-03<V2>	31	310	12.205	300	11.811
			SF4B-F39<V2>	SF4B-F39-01<V2>	SF4B-F39-03<V2>	39	390	15.354	380	14.960
			SF4B-F47<V2>	SF4B-F47-01<V2>	SF4B-F47-03<V2>	47	470	18.504	460	18.110
			SF4B-F55<V2>	SF4B-F55-01<V2>	SF4B-F55-03<V2>	55	550	21.654	540	21.260
			SF4B-F63<V2>	SF4B-F63-01<V2>	SF4B-F63-03<V2>	63	630	24.803	620	24.409
			SF4B-F71<V2>	SF4B-F71-01<V2>	SF4B-F71-03<V2>	71	710	27.953	700	27.559
			SF4B-F79<V2>	SF4B-F79-01<V2>	SF4B-F79-03<V2>	79	790	31.102	780	30.708
			SF4B-F95<V2>	SF4B-F95-01<V2>	SF4B-F95-03<V2>	95	950	37.402	940	37.007
			SF4B-F111<V2>	SF4B-F111-01<V2>	SF4B-F111-03<V2>	111	1,110	43.701	1,100	43.306
			SF4B-F127<V2>	SF4B-F127-01<V2>	SF4B-F127-03<V2>	127	1,270	50.000	1,260	49.606
			Hand protection type Min. sensing object ϕ 25 mm ϕ 0.984 in (20 mm 0.787 in beam pitch)		0.3 to 9 m 0.984 to 29.528 ft	SF4B-H12<V2>	SF4B-H12-01<V2>	SF4B-H12-03<V2>	12	230
SF4B-H16<V2>	SF4B-H16-01<V2>	SF4B-H16-03<V2>				16	310	12.205	300	11.811
SF4B-H20<V2>	SF4B-H20-01<V2>	SF4B-H20-03<V2>				20	390	15.354	380	14.960
SF4B-H24<V2>	SF4B-H24-01<V2>	SF4B-H24-03<V2>				24	470	18.504	460	18.110
SF4B-H28<V2>	SF4B-H28-01<V2>	SF4B-H28-03<V2>				28	550	21.654	540	21.260
SF4B-H32<V2>	SF4B-H32-01<V2>	SF4B-H32-03<V2>				32	630	24.803	620	24.409
SF4B-H36<V2>	SF4B-H36-01<V2>	SF4B-H36-03<V2>				36	710	27.953	700	27.559
SF4B-H40<V2>	SF4B-H40-01<V2>	SF4B-H40-03<V2>				40	790	31.102	780	30.708
SF4B-H48<V2>	SF4B-H48-01<V2>	SF4B-H48-03<V2>				48	950	37.402	940	37.007
SF4B-H56<V2>	SF4B-H56-01<V2>	SF4B-H56-03<V2>				56	1,110	43.701	1,100	43.306
SF4B-H64<V2>	SF4B-H64-01<V2>	SF4B-H64-03<V2>				64	1,270	50.000	1,260	49.606
SF4B-H72<V2>	SF4B-H72-01<V2>	SF4B-H72-03<V2>				72	1,430	56.299	1,420	55.905
SF4B-H80<V2>	SF4B-H80-01<V2>	SF4B-H80-03<V2>				80	1,590	62.598	1,580	62.205
SF4B-H88<V2>	SF4B-H88-01<V2>	SF4B-H88-03<V2>				88	1,750	68.898	1,740	68.503
SF4B-H96<V2>	SF4B-H96-01<V2>	SF4B-H96-03<V2>				96	1,910	75.197	1,900	74.803
Arm / Foot protection type Min. sensing object ϕ 45 mm ϕ 1.772 in (40 mm 1.575 in beam pitch)		0.3 to 9 m 0.984 to 29.528 ft				SF4B-A6<V2>	SF4B-A6-01<V2>	-	6	230
			SF4B-A8<V2>	SF4B-A8-01<V2>	-	8	310	12.205	280	11.024
			SF4B-A10<V2>	SF4B-A10-01<V2>	-	10	390	15.354	360	14.173
			SF4B-A12<V2>	SF4B-A12-01<V2>	-	12	470	18.504	440	17.323
			SF4B-A14<V2>	SF4B-A14-01<V2>	-	14	550	21.654	520	20.472
			SF4B-A16<V2>	SF4B-A16-01<V2>	-	16	630	24.803	600	23.622
			SF4B-A18<V2>	SF4B-A18-01<V2>	-	18	710	27.953	680	26.772
			SF4B-A20<V2>	SF4B-A20-01<V2>	-	20	790	31.102	760	29.921
			SF4B-A24<V2>	SF4B-A24-01<V2>	-	24	950	37.402	920	36.220
			SF4B-A28<V2>	SF4B-A28-01<V2>	-	28	1,110	43.701	1,080	42.520
			SF4B-A32<V2>	SF4B-A32-01<V2>	-	32	1,270	50.000	1,240	48.819
			SF4B-A36<V2>	SF4B-A36-01<V2>	-	36	1,430	56.299	1,400	55.118
			SF4B-A40<V2>	SF4B-A40-01<V2>	-	40	1,590	62.598	1,560	61.417
			SF4B-A44<V2>	SF4B-A44-01<V2>	-	44	1,750	68.898	1,720	67.716
			SF4B-A48<V2>	SF4B-A48-01<V2>	-	48	1,910	75.197	1,880	74.016

Notes: 1) The operating range is the possible setting distance between the emitter and the receiver. The light curtain can detect an object less than 0.3 m 0.984 ft away.

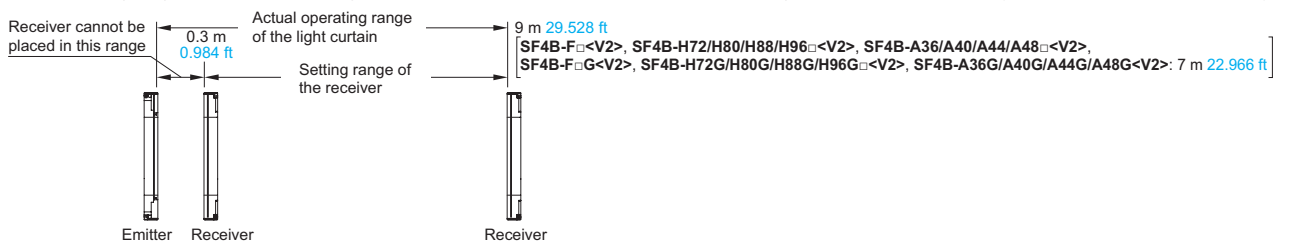

2) The model No. with "E" on the product label is the emitter, "D" on the label is the receiver.

3) Not conforming to Korean Press (SF4B-□-03<V2>)

ORDER GUIDE

1 Light curtains (Robust type) Mounting bracket and bottom cap cable are not supplied with the light curtain. Be sure to order them separately.

Type	Appearance	Operating range	Model No.		Number of beam channels	Protective height (mm in)				
				SFB-HC non-compatible			China Press compliant (GB4584)			
Finger protection type Min. sensing object $\phi 14$ mm $\phi 0.551$ in (10 mm 0.394 in beam pitch)		0.3 to 7 m 0.984 to 22.966 ft	SF4B-F23G<V2>	-	23	244 9.606	220 8.661			
			SF4B-F31G<V2>	-	31	324 12.756	300 11.811			
			SF4B-F39G<V2>	-	39	404 15.906	380 14.960			
			SF4B-F47G<V2>	-	47	484 19.055	460 18.110			
			SF4B-F55G<V2>	-	55	564 22.205	540 21.260			
			SF4B-F63G<V2>	-	63	644 25.354	620 24.409			
			SF4B-F71G<V2>	-	71	724 28.504	700 27.559			
			SF4B-F79G<V2>	-	79	804 31.654	780 30.708			
			SF4B-F95G<V2>	-	95	964 37.953	940 37.007			
			SF4B-F111G<V2>	-	111	1,124 44.252	1,100 43.306			
			SF4B-F127G<V2>	-	127	1,284 50.551	1,260 49.606			
Hand protection type Min. sensing object $\phi 25$ mm $\phi 0.984$ in (20 mm 0.787 in beam pitch)		0.3 to 9 m 0.984 to 29.529 ft	SF4B-H12G<V2>	SF4B-H12G-01<V2>	12	244 9.606	220 8.661			
			SF4B-H16G<V2>	SF4B-H16G-01<V2>	16	324 12.756	300 11.811			
			SF4B-H20G<V2>	SF4B-H20G-01<V2>	20	404 15.906	380 14.960			
			SF4B-H24G<V2>	SF4B-H24G-01<V2>	24	484 19.055	460 18.110			
			SF4B-H28G<V2>	SF4B-H28G-01<V2>	28	564 22.205	540 21.260			
			SF4B-H32G<V2>	SF4B-H32G-01<V2>	32	644 25.354	620 24.409			
			SF4B-H36G<V2>	SF4B-H36G-01<V2>	36	724 28.504	700 27.559			
			SF4B-H40G<V2>	SF4B-H40G-01<V2>	40	804 31.654	780 30.708			
			SF4B-H48G<V2>	SF4B-H48G-01<V2>	48	964 37.953	940 37.007			
			SF4B-H56G<V2>	SF4B-H56G-01<V2>	56	1,124 44.252	1,100 43.306			
			SF4B-H64G<V2>	SF4B-H64G-01<V2>	64	1,284 50.551	1,260 49.606			
			SF4B-H72G<V2>	SF4B-H72G-01<V2>	72	1,444 56.850	1,420 55.905			
			SF4B-H80G<V2>	SF4B-H80G-01<V2>	80	1,604 63.150	1,580 62.205			
			SF4B-H88G<V2>	SF4B-H88G-01<V2>	88	1,764 69.449	1,740 68.503			
			SF4B-H96G<V2>	SF4B-H96G-01<V2>	96	1,924 75.748	1,900 74.803			
			Arm / Foot protection type Min. sensing object $\phi 45$ mm $\phi 1.772$ in (40 mm 1.575 in beam pitch)		0.3 to 9 m 0.984 to 29.529 ft	SF4B-A6G<V2>	-	6	244 9.606	200 7.874
						SF4B-A8G<V2>	-	8	324 12.756	280 11.024
						SF4B-A10G<V2>	-	10	404 15.906	360 14.173
						SF4B-A12G<V2>	-	12	484 19.055	440 17.323
SF4B-A14G<V2>	-	14				564 22.205	520 20.472			
SF4B-A16G<V2>	-	16				644 25.354	600 23.622			
SF4B-A18G<V2>	-	18				724 28.504	680 26.772			
SF4B-A20G<V2>	-	20				804 31.654	760 29.921			
SF4B-A24G<V2>	-	24				964 37.953	920 36.220			
SF4B-A28G<V2>	-	28				1,124 44.252	1,080 42.520			
SF4B-A32G<V2>	-	32				1,284 50.551	1,240 48.819			
SF4B-A36G<V2>	-	36				1,444 56.850	1,400 55.118			
SF4B-A40G<V2>	-	40				1,604 63.150	1,560 61.417			
SF4B-A44G<V2>	-	44				1,764 69.449	1,720 67.716			
SF4B-A48G<V2>	-	48				1,924 75.748	1,880 74.016			

Differences from standard type

The robust type SF4B-□G□<V2> is different from the standard type SF4B-□<V2> in the following ways:

- Sensing width (protective height) • Profile • Net weight • Mounting bracket • Front protection cover
- Laser alignment tool • Noncompliant with Japanese and Korean press standard
- Noncompliant with Korean regulations

Other specifications, input/output circuits, and options are the same as for the standard type.

ORDER GUIDE

2 Mounting brackets Mounting bracket is not supplied with the light curtain. Be sure to order it separately.

Designation		Model No.	Description
Rear / side mounting bracket [Material: Cold rolled carbon steel (SPCC)]	M8 rear mounting bracket	MS-SFB-7-T	For rear mounting. Allows the light curtain to be mounted at the rear with one M8 hexagon-socket-head bolt. (4 pcs. per set for emitter and receiver)
	M8 side mounting bracket	MS-SFB-8-T	For side mounting. Allows the light curtain to be mounted at the side with one M8 hexagon-socket-head bolt. (4 pcs. per set for emitter and receiver)
	M8 rear / side mounting bracket set	MS-SFB-1-T2	Can be used as either a rear mounting bracket MS-SFB-7-T or a side mounting bracket MS-SFB-8-T depending on mounting direction. (4 pcs. per set for emitter and receiver)
360° mounting bracket (Material: Die-cast zinc alloy)	Standard mounting bracket	MS-SFB-1	Used to mount the light curtain on the rear surface and side surface. (4 pcs. per set for emitter and receiver)
	M8 mounting bracket	MS-SFB-1-T	Allows the light curtain to be mounted at the rear and side with one M8 hexagon-socket-head bolt. (4 pcs. per set for emitter and receiver)
	Pitch adapter bracket	MS-SFB-4	Used as the mounting bracket when changing over a previous light curtain with a protective height of 200 mm 7.874 in or more to the SF4B series. It is installed using two M5 hexagon-socket-head bolts. (4 pcs. per set for emitter and receiver)
* Light curtain can revolve 360° horizontally.	M8 pitch adapter bracket	MS-SFB-4-T	Used as the mounting bracket when changing over a previous light curtain with a protective height of 200 mm 7.874 in or more to the SF4B series. It is installed using one M8 hexagon-socket-head bolt. (4 pcs. per set for emitter and receiver)
Dead zoneless mounting bracket (Material: Die-cast zinc alloy)		MS-SFB-3	Mounting with no dead zone is possible so that the mounting bracket does not project past the protective height. (4 pcs. per set for emitter and receiver)
Standard L mounting bracket (For SF4B-□G□) [Material: Cold rolled carbon steel (SPCC)] (Trivalent chrome plated)		MS-SF4BG-1	Mounting is possible behind or at the side of the light curtain. Mount with two M5 bolts or one M8 bolt. (4 pcs. per set for emitter and receiver)
Dead zoneless mounting bracket (For SF4B-□G□) Material: Mounting bracket ... Cold rolled carbon steel (SPCC) (Trivalent chrome plated) Supporting bracket ... PPS		MS-SF4BG-3	Allows light curtains to be installed closely together or in locations with installation restrictions due to equipment columns or jigs. (4 pcs. per set for emitter and receiver)

M8 rear mounting bracket M8 side mounting bracket Standard mounting bracket M8 mounting bracket Pitch adapter bracket

- **MS-SFB-7-T**
- **MS-SFB-1-T2**
- (Rear mounting)

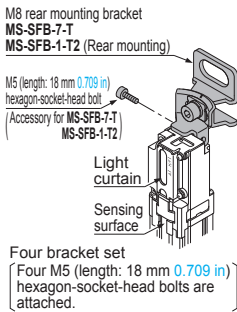

- **MS-SFB-8-T**
- **MS-SFB-1-T2**
- (Side mounting)

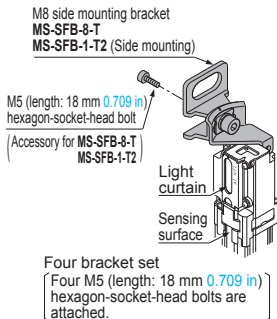

- **MS-SFB-1**

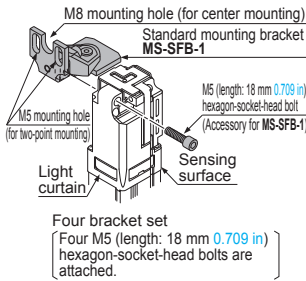

- **MS-SFB-1-T**

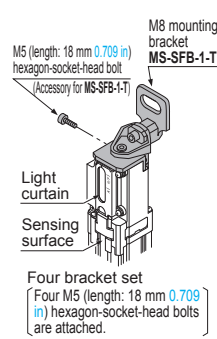

- **MS-SFB-4**

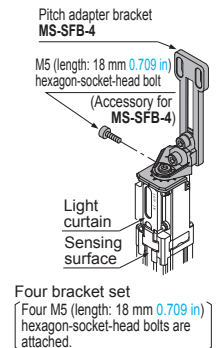

M8 pitch adapter bracket

- **MS-SFB-4-T**

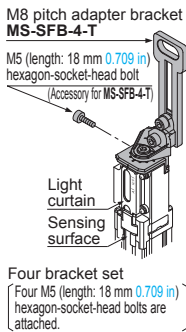

Dead zoneless mounting bracket

- **MS-SFB-3**

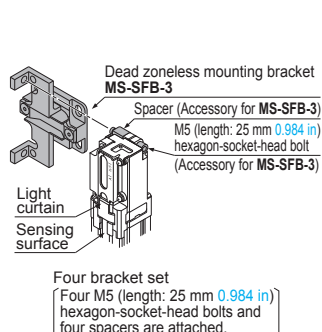

Standard L mounting bracket (For SF4B-□G□)

- **MS-SF4BG-1**

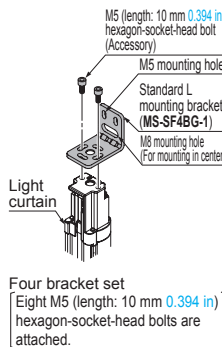

Dead zoneless mounting bracket (For SF4B-□G□)

- **MS-SF4BG-3**

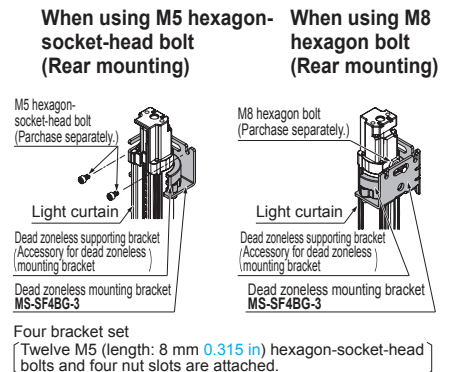

ORDER GUIDE

3 4 5 6 7 Mating cable / Extension cable / Cables for series connection Mating cable is not supplied with the light curtain. Be sure to order it separately.

Type	Appearance	Model No.	Description (Note)	
Standard components (8-core cable)	Bottom cap cable Discrete wire	SFB-CCB3	Length: 3 m 9.843 ft Net weight: 370 g approx. (2 cables)	
		SFB-CCB7	Length: 7 m 22.966 ft Net weight: 820 g approx. (2 cables)	
		SFB-CCB10	Length: 10 m 32.808 ft Net weight: 1,160 g approx. (2 cables)	
		SFB-CCB15	Length: 15 m 49.213 ft Net weight: 1,710 g approx. (2 cables)	
	Connector	SFB-CB05	Length: 0.5 m 1.640 ft Net weight: 95 g approx. (2 cables)	
		SFB-CB5	Length: 5 m 16.404 ft Net weight: 620 g approx. (2 cables)	
		SFB-CB10	Length: 10 m 32.808 ft Net weight: 1,200 g approx. (2 cables)	
	Extension cable With connector on one end	SFB-CC3	Length: 3 m 9.843 ft Net weight: 380 g approx. (2 cables)	
		SFB-CC10	Length: 10 m 32.808 ft Net weight: 1,200 g approx. (2 cables)	
	Extension cable With connectors on both ends	For emitter	SFB-CCJ3E	Length: 3 m 9.843 ft Net weight: 190 g approx. (1 cable)
			SFB-CCJ10E	Length: 10 m 32.808 ft Net weight: 580 g approx. (1 cable)
		For receiver	SFB-CCJ3D	Length: 3 m 9.843 ft Net weight: 210 g approx. (1 cable)
SFB-CCJ10D			Length: 10 m 32.808 ft Net weight: 600 g approx. (1 cable)	
Mating control components (12-core cable, with interference prevention wire)	Bottom cap cable Discrete wire	SFB-CCB3-MU	Length: 3 m 9.843 ft Net weight: 420 g approx. (2 cables)	
		SFB-CCB7-MU	Length: 7 m 22.966 ft Net weight: 930 g approx. (2 cables)	
	Connector	SFB-CB05-MU	Length: 0.5 m 1.640 ft Net weight: 110 g approx. (2 cables)	
		SFB-CC3-MU	Length: 3 m 9.843 ft Net weight: 430 g approx. (2 cables)	
	Extension cable With connector on one end	SFB-CC7-MU	Length: 7 m 22.966 ft Net weight: 1,000 g approx. (2 cables)	
		SFB-CC10-MU	Length: 10 m 32.808 ft Net weight: 1,300 g approx. (2 cables)	
For emitter		SFB-CCJ3E-MU	Length: 3 m 9.843 ft Net weight: 190 g approx. (1 cable)	
		SFB-CCJ10E-MU	Length: 10 m 32.808 ft Net weight: 660 g approx. (1 cable)	
For receiver	SFB-CCJ3D-MU	Length: 3 m 9.843 ft Net weight: 210 g approx. (1 cable)		
	SFB-CCJ10D-MU	Length: 10 m 32.808 ft Net weight: 680 g approx. (1 cable)		
Cable for series connection		SFB-CSL01	Length: 0.1 m 0.328 ft Net weight: 45 g approx. (2 cables)	
		SFB-CSL05	Length: 0.5 m 1.640 ft Net weight: 95 g approx. (2 cables)	
		SFB-CSL1	Length: 1 m 3.281 ft Net weight: 150 g approx. (2 cables)	
		SFB-CSL5	Length: 5 m 16.404 ft Net weight: 630 g approx. (2 cables)	
Exclusive mating cable for SF-C14EX		SFB-CB05-EX	Length: 0.5 m 1.640 ft Net weight: 95 g approx. (2 cables)	
		SFB-CB5-EX	Length: 5 m 16.404 ft Net weight: 620 g approx. (2 cables)	
		SFB-CB10-EX	Length: 10 m 32.808 ft Net weight: 1,200 g approx. (2 cables)	
Adapter cable		SFB-CB05-A-P	Length: 0.5 m 1.640 ft Net weight: 110 g approx. (2 cables)	
		SFB-CB05-A-N		
		SFB-CB05-B-P		
		SFB-CB05-B-N		

Note: Where the cable color has not been specified, it is black for emitter, gray with black line for outer diameter is $\phi 6$ mm **0.236 in**, min. bending radius is R6 mm **R0.236 in**.

For details of mating cable of CC-Link Safety system remote I/O unit with connectors for light curtain **SF-CL1T264T**, refer to website.

ORDER GUIDE

Spare parts (Accessories for light curtain)

Designation	Model No.	Description
Intermediate supporting bracket (Excluding SF4B-□G□) (Note 1)	MS-SFB-2	Used to mount the light curtain on the intermediate position. (2 pcs. per set for emitter and receiver) Mounting is possible behind or at the side of the light curtain.
Intermediate supporting bracket (Note 2) (For SF4B-□G□)	MS-SF4BG-2	Used to mount the light curtain in the intermediate position. (2 pcs. per set for emitter and receiver) Mounting is possible behind or at the side of the light curtain.
Test rod ø14	SF4B-TR14	Min. sensing object for regular checking (ø14 mm ø0.551 in), with finger protection type (min. sensing object ø14 mm ø0.551 in)
Test rod ø25	SF4B-TR25	Min. sensing object for regular checking (ø25 mm ø0.984 in), with hand protection type (min. sensing object ø25 mm ø0.984 in)

Notes: 1) The number of sets required varies depending on the product.

- 1 set: **SF4B-F□<V2>** Light curtain with 79 to 111 beam channels
SF4B-H□<V2> Light curtain with 40 to 56 beam channels
SF4B-A□<V2> Light curtain with 20 to 28 beam channels
- 2 sets: **SF4B-F127□<V2>**
SF4B-H□<V2> Light curtain with 64 to 80 beam channels
SF4B-A□<V2> Light curtain with 32 to 40 beam channels
- 3 sets: **SF4B-H□<V2>** Light curtain with 88 to 96 beam channels
SF4B-A□<V2> Light curtain with 44 to 48 beam channels

2) The number of sets required varies depending on the product.

- 1 set: **SF4B-F□G□<V2>** Light curtain with 79 to 127 beam channels
SF4B-H□G□<V2> Light curtain with 40 to 64 beam channels
SF4B-A□G□<V2> Light curtain with 20 to 32 beam channels
- 2 set: **SF4B-H□G□<V2>** Light curtain with 72 to 96 beam channels
SF4B-A□G□<V2> Light curtain with 36 to 48 beam channels

Intermediate supporting bracket

• MS-SFB-2

<In case of rear mounting>

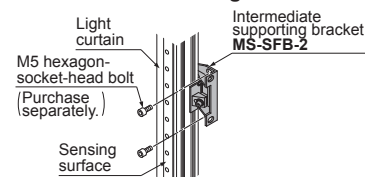

<In case of side mounting>

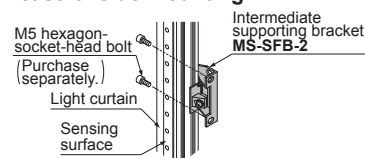

• MS-SF4BG-2

<In case of rear mounting>

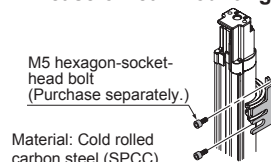

Material: Cold rolled carbon steel (SPCC)

<In case of side mounting>

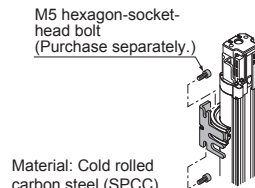

Material: Cold rolled carbon steel (SPCC)

OPTIONS

Exclusive control units

Designation	Appearance	Model No.	Application cable	Description
Connector connection type control unit		SF-C11	Bottom cap cable: SFB-CB□ Extension cable: SFB-CCJ□	Use 8-core cable with connector to connect to the light curtain. Compatible with up to Control Category 4. Interference prevention wires and muting function cannot be used.
Robust type control unit		SF-C12	Bottom cap cable: SFB-CB05-MU Extension cable: SFB-CCJ□-MU	Use 12-core cable with connector to connect to the light curtain. Compatible with up to Control Category 4. Muting function cannot be used. Interference prevention wires can be used.
Slim type control unit		SF-C13	Bottom cap cable: SFB-CCB□(-MU) Extension cable: SFB-CC□(-MU)	Use a discrete wire cable to connect to the light curtain. Compatible with up to Control Category 4. Interference prevention wires and muting function can be used.
Application expansion unit for SF4B series		SF-C14EX	Bottom cap cable: SFB-CB□-EX Extension cable: SFB-CCJ□	The muting control function and emergency stop input expand the applications of the light curtains. Use exclusive cable to connect to the light curtain. Compatible with up to Control Category 4. The handy-controller SFB-HC cannot be used with SF-C14EX-01 .
Handy-controller non-compatible type		SF-C14EX-01		
CC-Link Safety system remote I/O unit for light curtain (Note)		SF-CL1T264T	Bottom cap cable: SFB-CB□-CL Extension cable: SFB-CCJ10□-CL	This is a remote I/O unit that allows the safety field network "CC-Link Safety" to be connected to the light curtains or the safety components. Use exclusive cable to connect to the light curtain. Compatible with up to Control Category 4. Please contact our office for details.

Note: Refer to our website for details of the remote I/O unit **SF-CL1T264T**.

SF-C12 spare relay set

A set of spare relays (2 safety relays and 1 removal tool) is available for the safety relay that is built into the **SF-C12**.
Model No.: **SF-C12-RY**

OPTIONS

Recommended safety relay

Safety relay
Panasonic Corporation
SF relay slim type

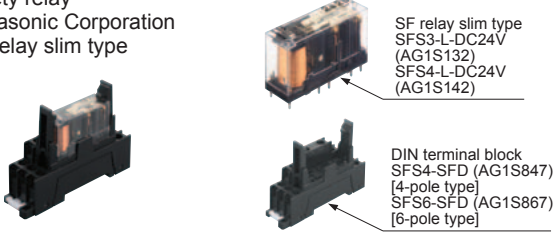

Note: Contact Panasonic Corporation for details on the recommended products.

Type	With LED indicator		
	Model No.	SFS3-L-DC24V	SFS4-L-DC24V
Item	Part No.	AG1S132	AG1S142
Contact arrangement		3a1b	4a2b
Rated nominal switching capacity		6 A / 250 V AC, 6 A / 30 V DC	
Min. switching capacity		1 mA / 5 V DC	
Coil rating		15 mA / 24 V DC	20.8 mA / 24 V DC
Rated power consumption		360 mW	500 mW
Operation time		20 ms or less	
Release time		20 ms or less	
Ambient temperature		-40 to +85 °C -40 to +185 °F (Humidity: 5 to 85 % RH)	
Applicable standards		UL, C-UL, TÜV, Korea S-mark	

Handy-controller

Designation	Appearance	Model No.
Handy-controller	 * Includes 2 adapter cables	SFB-HC (Note)
Cable set for cable type connection		SFC-WNC1 (Note)

Note: A handy-controller cannot be used with the **SF4B-□-01<V2>**, the **SF4B-□-03<V2>** and the **SF-C14EX-01**.

Pigtailed type

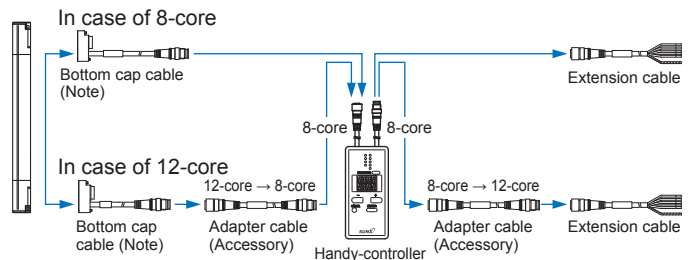

Note: If using a bottom cap cable with discrete wire, please order the **SFB-CC3/CC10** separately. Refer to the instruction manual for the light curtain for details on wiring.

Cable type

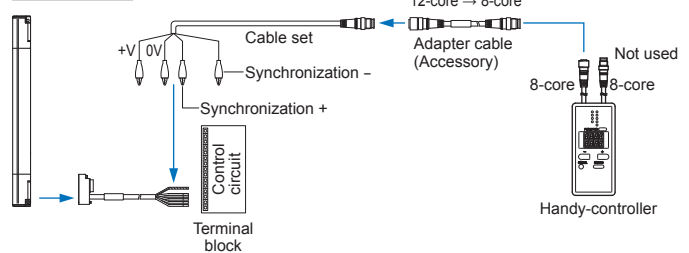

Y-shaped connector

Type	Appearance	Model No.	Description
Wire-saving Y-shaped connector		SFB-WY1 (Note)	Wire-saving connector for standard components (8-core cable). Cables of emitter and receiver are consolidated into one cable for wire-saving. Wiring has +24 V, 0 V, OSSD 1, OSSD 2, output polarity setting wire (shield). [Power wire and synchronization wire are connected inside the connector.] [Interlock is disabled (automatic reset).]
Cable with connector on one side		WY1-CCN3 (Note)	Cable length: 3 m 9.843 ft Net weight: 200 g approx. (1 cable)
		WY1-CCN10 (Note)	Cable length: 10 m 32.808 ft Net weight: 620 g approx. (1 cable)

Note: Not available for **SF4B-□-01<V2>**.

By using the Y-shaped connector, the least required wires such as power or safety output are consolidated into one cable. Man-hours taken for wiring is eliminated to the minimum. Construction times as well as wiring mistakes are greatly reduced.

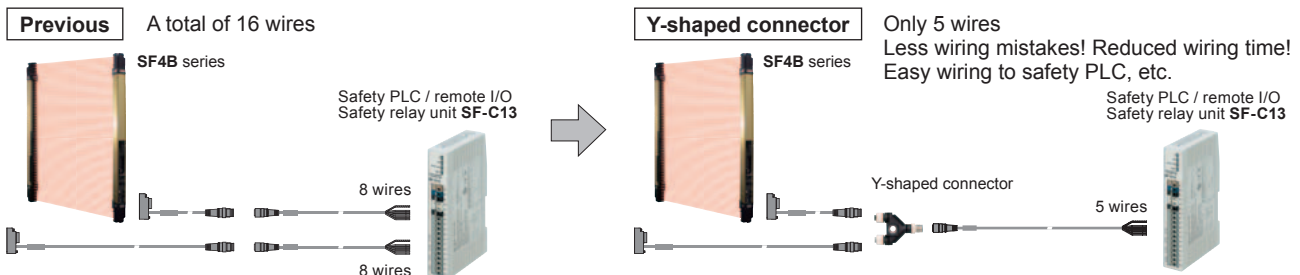

Refer to the operation manual **SF4B <V2>** for more detail such as installation of Y-shaped connector, terminal wiring, and wiring example.

OPTIONS

Product configuration

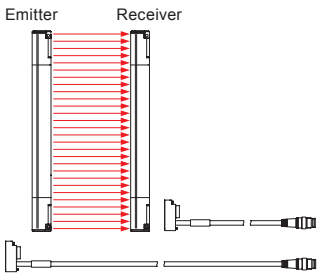

**Extension cable
(1 cable for receiver)**
SFB-CCJ3D (3 m 9.843 ft)
SFB-CCJ10D (10 m 32.808 ft)



**Bottom cap cable
(2 cables for emitter and receiver)**
SFB-CB05 (0.5 m 1.64 ft)
SFB-CB5 (5 m 16.404 ft)
SFB-CB10 (10 m 32.808 ft)

**Extension cable
(1 cable for emitter)**
SFB-CCJ3E (3 m 9.843 ft)
SFB-CCJ10E (10 m 32.808 ft)



**Y-shaped connector
SFB-WY1**

Extension cable
SFB-CCJ3D (3 m 9.843 ft)
SFB-CCJ10D (10 m 32.808 ft)

**Cable with connector on one side
(Common for all models)**

WY1-CCN3 (3 m 9.843 ft)
WY1-CCN10 (10 m 32.808 ft)

Connector pin layout

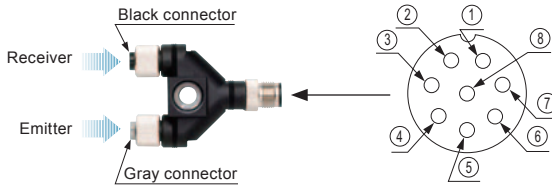

Connector pin No.	Description
①	OSSD 2
②	+24 V
③	OSSD 1
④	Not used
⑤	Not used
⑥	Not used
⑦	0 V
⑧	Output polarity setting wire (Shield)

Wiring diagram of control unit SF-C13

For PNP output (minus ground)

- Connect the light curtain control outputs OSSD 1 and OSSD 2 to S1 and S2 respectively.

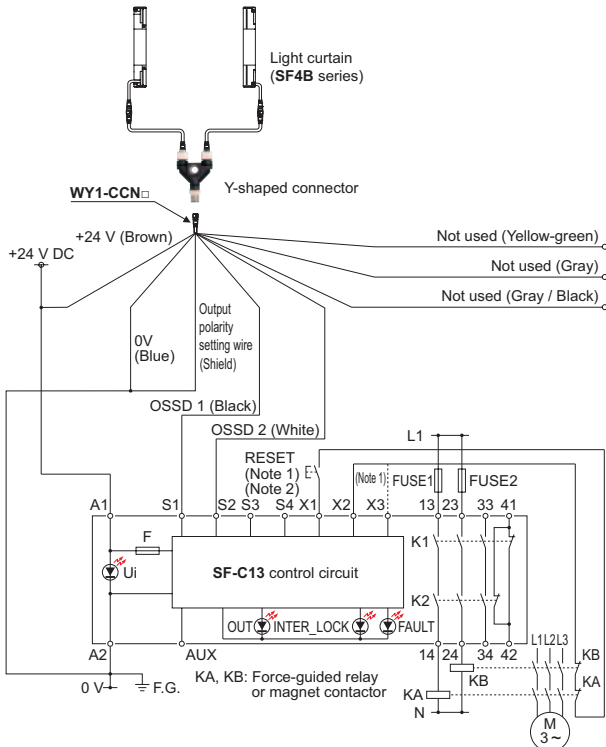

For NPN output (plus ground)

- Connect the light curtain control outputs OSSD 1 and OSSD 2 to S4 and S2 respectively and ground the + side.

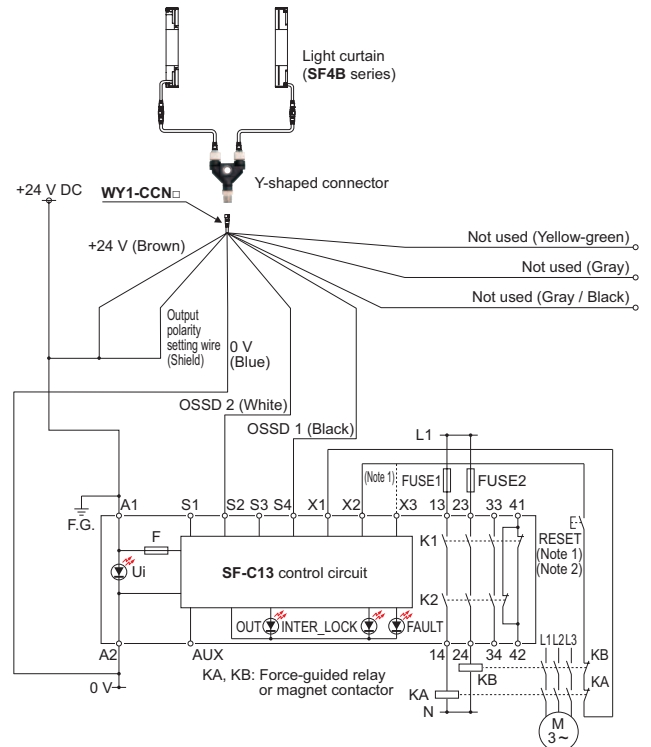

- Notes: 1) The above diagram is when using manual reset. If automatic reset is used, disconnect the lead from X2 and connect it to X3. In this case, a reset (RESET) button is not needed.
 2) Use a momentary-type switch as the reset (RESET) button.
 3) Unused wires must be insulated.

- Notes: 1) The above diagram is when using manual reset. If automatic reset is used, disconnect the lead from X2 and connect it to X3. In this case, a reset (RESET) button is not needed.
 2) Use a momentary-type switch as the reset (RESET) button.
 3) Unused wires must be insulated.

OPTIONS

Front protection cover (except for SF4B-□G□) / Protection bar set (except for SF4B-□G□) / Corner mirror

Designation			Front protection cover	Protection bar set	Rear / side protection bar set	Corner mirror	
Finger	Hand	Arm / foot				Model No.	Model No.
23	12	6	FC-SFBH-12	MC-SFBH-12	MC-SFBH-12-T	RF-SFBH-12	236 × 72 mm 9.291 × 2.835 in
31	16	8	FC-SFBH-16	MC-SFBH-16	MC-SFBH-16-T	RF-SFBH-16	316 × 72 mm 12.441 × 2.835 in
39	20	10	FC-SFBH-20	MC-SFBH-20	MC-SFBH-20-T	RF-SFBH-20	396 × 72 mm 15.591 × 2.835 in
47	24	12	FC-SFBH-24	MC-SFBH-24	MC-SFBH-24-T	RF-SFBH-24	476 × 72 mm 18.740 × 2.835 in
55	28	14	FC-SFBH-28	MC-SFBH-28	MC-SFBH-28-T	RF-SFBH-28	556 × 72 mm 21.890 × 2.835 in
63	32	16	FC-SFBH-32	MC-SFBH-32	MC-SFBH-32-T	RF-SFBH-32	636 × 72 mm 25.039 × 2.835 in
71	36	18	FC-SFBH-36	MC-SFBH-36	MC-SFBH-36-T	RF-SFBH-36	716 × 72 mm 28.189 × 2.835 in
79	40	20	FC-SFBH-40	MC-SFBH-40	MC-SFBH-40-T	RF-SFBH-40	796 × 72 mm 31.339 × 2.835 in
95	48	24	FC-SFBH-48	MC-SFBH-48	MC-SFBH-48-T	RF-SFBH-48	956 × 72 mm 37.638 × 2.835 in
111	56	28	FC-SFBH-56	MC-SFBH-56	MC-SFBH-56-T	RF-SFBH-56	1,116 × 72 mm 43.937 × 2.835 in
127	64	32	FC-SFBH-64	MC-SFBH-64	MC-SFBH-64-T	RF-SFBH-64	1,276 × 72 mm 50.236 × 2.835 in
–	72	36	FC-SFBH-72	MC-SFBH-72	MC-SFBH-72-T	RF-SFBH-72	1,436 × 72 mm 56.535 × 2.835 in
–	80	40	FC-SFBH-80	MC-SFBH-80	MC-SFBH-80-T	RF-SFBH-80	1,596 × 72 mm 62.835 × 2.835 in
–	88	44	FC-SFBH-88	MC-SFBH-88	MC-SFBH-88-T	RF-SFBH-88	1,756 × 72 mm 69.134 × 2.835 in
–	96	48	FC-SFBH-96	MC-SFBH-96	MC-SFBH-96-T	RF-SFBH-96	1,916 × 72 mm 75.433 × 2.835 in

Note: The model Nos. given above denote a single unit, not a pair of units. 2 units are required for use in mounting to the emitter / receiver. (Except for corner mirror)

Front protection cover

• FC-SFBH-□

Protects sensing surface of the light curtain from flying objects such as welding spatter.

The operating range reduces when the front protection cover is used.

Note: Not available for SF4B-□G□.

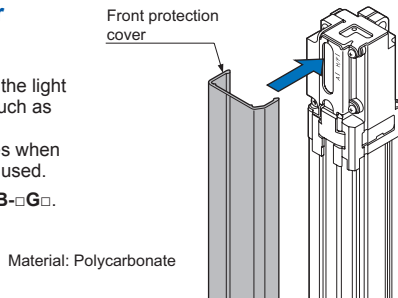

Material: Polycarbonate

Protection bar set

• MC-SFBH-□

* Not available for SF4B-□G□.

Rear / side protection bar set

• MC-SFBH-□-T

* Not available for SF4B-□G□.

<Rear mounting>

<Side mounting>

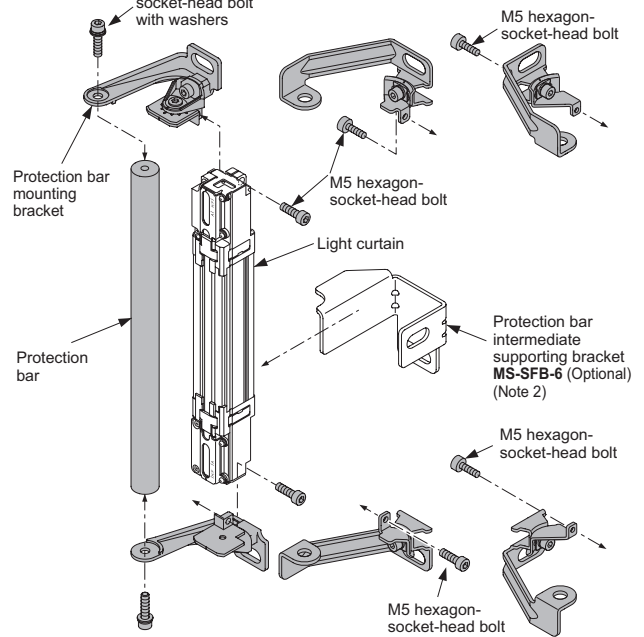

Sensing range

	SF4B-F□	SF4B-H□		SF4B-A□	
		12 to 64 beam axes type	72 to 96 beam axes type	6 to 32 beam axes type	36 to 48 beam axes type
Only emitter installed	0.3 to 6 m 0.984 to 19.685 ft	0.3 to 7.5 m 0.984 to 24.606 ft	0.3 to 6 m 0.984 to 19.685 ft	0.3 to 7.5 m 0.984 to 24.606 ft	0.3 to 6 m 0.984 to 19.685 ft
Only receiver installed	0.3 to 6 m 0.984 to 19.685 ft	0.3 to 7.5 m 0.984 to 24.606 ft	0.3 to 6 m 0.984 to 19.685 ft	0.3 to 7.5 m 0.984 to 24.606 ft	0.3 to 6 m 0.984 to 19.685 ft
Both emitter and receiver installed	0.3 to 5.5 m 0.984 to 18.045 ft	0.3 to 7 m 0.984 to 22.966 ft	0.3 to 5.5 m 0.984 to 18.045 ft	0.3 to 7 m 0.984 to 22.966 ft	0.3 to 5.5 m 0.984 to 18.045 ft

Note: The operating range is the possible setting distance between the emitter and the receiver.

Corner mirror

• RF-SFBH-□

Normally for an L-shaped or U-shaped installation, 2 or 3 sets of light curtains are needed. With the use of a corner mirror reflecting the light, one set of light curtain is possible for L-shaped or U-shaped installation.

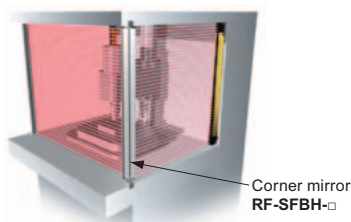

Sensing range

With 1 mirror	Declined to 90 %
With 2 mirrors	Declined to 80 %

• Parts List

Designation	MC-SFBH-□		MC-SFBH-□-T	
	Number	Remarks	Number	Remarks
Protection bar	1 pc.	Material: Aluminum	1 pc.	Material: Aluminum
Protection bar mounting bracket (For left side, for right side)	1 pc. each	Material: Die-cast zinc alloy	1 pc. each (Note 1)	Material: Cold rolled carbon steel (SPCC) (Trivalent chrome plated)
Hexagon-socket-head bolt with washers	2 pcs.	M5 (length: 20 mm 0.787 in)	2 pcs.	M5 (length: 20 mm 0.787 in)
Hexagon-socket-head bolt	2 pcs.	M5 (length: 16 mm 0.630 in)	2 pcs.	M5 (length: 18 mm 0.709 in)
Protection bar intermediate supporting bracket MS-SFB-6 (Optional) (Note 2)	1 pc.	Material: Cold rolled carbon steel (SPCC) (Trivalent chrome plated)	1 pc.	Material: Cold rolled carbon steel (SPCC) (Trivalent chrome plated)

Notes: 1) Available as a spare part. Model No.: MS-MCSFB-1-T

2) The protection bar intermediate supporting bracket MS-SFB-6 (optional) is installed to protection bars that are longer than the MC-SFBH-48(-T). Use if there is much flexure bending in the protection bar. Please contact our office for details.

Front protection cover (For SF4B-□G□)

Designation			Front protection cover
Finger	Hand	Arm / foot	Model No.
23	12	6	FC-SF4BG-H12
31	16	8	FC-SF4BG-H16
39	20	10	FC-SF4BG-H20
47	24	12	FC-SF4BG-H24
55	28	14	FC-SF4BG-H28
63	32	16	FC-SF4BG-H32
71	36	18	FC-SF4BG-H36
79	40	20	FC-SF4BG-H40
95	48	24	FC-SF4BG-H48
111	56	28	FC-SF4BG-H56
127	64	32	FC-SF4BG-H64
-	72	36	FC-SF4BG-H72
-	80	40	FC-SF4BG-H80
-	88	44	FC-SF4BG-H88
-	96	48	FC-SF4BG-H96

Note: The model Nos. given above denote a single unit, not a pair of units. 2 units are required for use in mounting to the emitter / receiver.

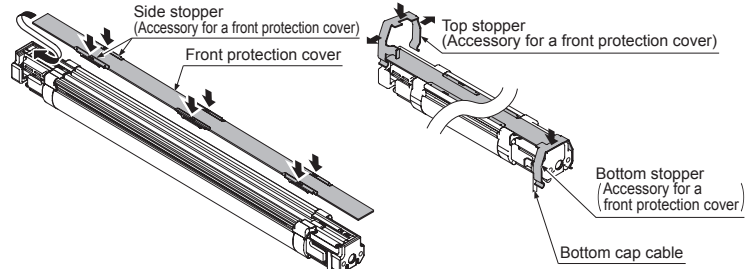

Material: Front protection cover ... Polycarbonate
Top / Side / Bottom stopper ... Stainless steel (SUS304)

Sensing range

	SF4B-F□G<V2>	SF4B-H□G□<V2>		SF4B-A□G□<V2>	
		12 to 64 beam axes type	72 to 96 beam axes type	6 to 32 beam axes type	36 to 48 beam axes type
Only emitter installed	0.3 to 6 m 0.984 to 19.685 ft	0.3 to 7.5 m 0.984 to 24.606 ft	0.3 to 6 m 0.984 to 19.685 ft	0.3 to 7.5 m 0.984 to 24.606 ft	0.3 to 6 m 0.984 to 19.685 ft
Only receiver installed					
Both emitter and receiver installed	0.3 to 5.5 m 0.984 to 18.045 ft	0.3 to 7 m 0.984 to 22.966 ft	0.3 to 5.5 m 0.984 to 18.045 ft	0.3 to 7 m 0.984 to 22.966 ft	0.3 to 5.5 m 0.984 to 18.045 ft

Note: The operating range is the possible setting distance between the emitter and the receiver.

Designation	Model No.	Description
Test rod ø45	SF4B-TR45	Min. sensing object for regular checking (ø45 mm ø1.772 in), with arm / foot protection type (min. sensing object ø45 mm ø1.772 in)
Laser alignment tool (Excluding SF4B-□G□)	SF-LAT-2N	Allows easy beam axis alignment using easy-to-see laser beam
Laser alignment tool (For SF4B-□G□)	SF-LAT-4BG	Allows easy beam axis alignment using easy-to-see laser beam
Caution tape	SF-TP-BG10	Attached to the side of the light curtain to alert workers to hazards (10 m 32.8 ft long)

Laser alignment tool (Excluding SF4B-□G□)

- SF-LAT-2N

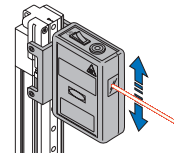

Laser alignment tool (For SF4B-□G□)

- SF-LAT-4BG

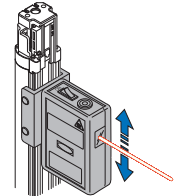

Caution tape

- SF-TP-BG10



Designation	Model No.	Description
Large display unit for light curtain	SF-IND-2	<p>With the auxiliary output of the light curtain, the operation is easily observable from various directions.</p> <p>Specifications</p> <ul style="list-style-type: none"> • Supply voltage: 24 V DC ±15 % • Current consumption: 12 mA or less • Indicators: Orange LED (8 pcs. used) [Light up when external contact is ON] • Ambient temperature: -10 to +55 °C +14 to +131 °F (No dew condensation or icing allowed) • Material: POM (Enclosure) Polycarbonate (Cover) Cold rolled carbon steel (SPCC) (Bracket) • Cable: 0.3 mm² 2-core cabtyre cable, 3 m 9.843 ft long • Weight: 70 g approx. (including bracket) <p>I/O circuit diagrams</p> <p>With NPN output type</p> <p>With PNP output type</p>

Large display unit for light curtain

- SF-IND-2

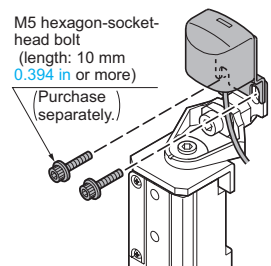

Attaches to top of light curtain. Tighten together the mounting bracket provided with the light curtain MS-SFB-1/4, MS-SFBG-1 and the attached mounting bracket of SF-IND-2.

SPECIFICATIONS

Light curtain individual specifications

SF4B-F□(G)<V2>

Type	Min. sensing object $\varnothing 14$ mm $\varnothing 0.551$ in type (10 mm 0.394 in beam pitch)										
Item	Model No. (Note 2)	SF4B-F23□<V2>	SF4B-F23G<V2>	SF4B-F31□<V2>	SF4B-F31G<V2>	SF4B-F39□<V2>	SF4B-F39G<V2>	SF4B-F47□<V2>	SF4B-F47G<V2>	SF4B-F55□<V2>	SF4B-F55G<V2>
Number of beam channels		23		31		39		47		55	
Protective height		230 mm 9.055 in	244 mm 9.606 in	310 mm 12.205 in	324 mm 12.756 in	390 mm 15.354 in	404 mm 15.906 in	470 mm 18.504 in	484 mm 19.055 in	550 mm 21.654 in	564 mm 22.205 in
China Press compliant (GB4584)		220 mm 8.661 in		300 mm 11.811 in		380 mm 14.960 in		460 mm 18.110 in		540 mm 21.260 in	
Current consumption		Emitter: 80 mA or less, Receiver: 120 mA or less						Emitter: 100 mA or less, Receiver: 160 mA or less			
PFHd		2.4×10^{-9}		2.8×10^{-9}		3.2×10^{-9}		3.6×10^{-9}		4.0×10^{-9}	
MTTFd		100 years or more									
Net weight (Total of emitter and receiver)		510 g approx.	980 g approx.	660 g approx.	1,340 g approx.	810 g approx.	1,700 g approx.	960 g approx.	2,000 g approx.	1,110 g approx.	2,400 g approx.

Type	Min. sensing object $\varnothing 14$ mm $\varnothing 0.551$ in type (10 mm 0.394 in beam pitch)								
Item	Model No. (Note 2)	SF4B-F63□<V2>	SF4B-F63G<V2>	SF4B-F71□<V2>	SF4B-F71G<V2>	SF4B-F79□<V2>	SF4B-F79G<V2>	SF4B-F95□<V2>	SF4B-F95G<V2>
Number of beam channels		63		71		79		95	
Protective height		630 mm 24.803 in	644 mm 25.354 in	710 mm 27.953 in	724 mm 28.504 in	790 mm 31.102 in	804 mm 31.654 in	950 mm 37.402 in	964 mm 37.953 in
China Press compliant (GB4584)		620 mm 24.409 in		700 mm 27.559 in		780 mm 30.708 in		940 mm 37.007 in	
Current consumption		Emitter: 100 mA or less, Receiver: 160 mA or less				Emitter: 115 mA or less, Receiver: 190 mA or less			
PFHd		4.4×10^{-9}		4.8×10^{-9}		5.2×10^{-9}		6.0×10^{-9}	
MTTFd		100 years or more							
Net weight (Total of emitter and receiver)		1,260 g approx.	2,800 g approx.	1,420 g approx.	3,200 g approx.	1,570 g approx.	3,400 g approx.	1,870 g approx.	4,200 g approx.

Type	Min. sensing object $\varnothing 14$ mm $\varnothing 0.551$ in type (10 mm 0.394 in beam pitch)				
Item	Model No. (Note 2)	SF4B-F111□<V2>	SF4B-F111G<V2>	SF4B-F127□<V2>	SF4B-F127G<V2>
Number of beam channels		111		127	
Protective height		1,110 mm 43.701 in	1,124 mm 44.252 in	1,270 mm 50.000 in	1,284 mm 50.551 in
China Press compliant (GB4584)		1,100 mm 43.306 in		1,260 mm 49.606 in	
Current consumption		Emitter: 135 mA or less, Receiver: 230 mA or less			
PFHd		6.8×10^{-9}		7.6×10^{-9}	
MTTFd		100 years or more			
Net weight (Total of emitter and receiver)		2,170 g approx.	5,000 g approx.	2,470 g approx.	5,600 g approx.

Notes: 1) Where measurement conditions have not been specified precisely, the conditions used were an ambient temperature of +20 °C +68 °F. The model No. with "G" is a robust type.
2) The models with the "-01" or "-03" cannot be used with the handy-controller SFB-HC.

SPECIFICATIONS

SF4B-H□(G□)<V2>

Type	Min. sensing object ø25 mm ø0.984 in type (20 mm 0.787 in beam pitch)										
Item	Model No. (Note 2)	SF4B-H12□<V2>	SF4B-H12G□<V2>	SF4B-H16□<V2>	SF4B-H16G□<V2>	SF4B-H20□<V2>	SF4B-H20G□<V2>	SF4B-H24□<V2>	SF4B-H24G□<V2>	SF4B-H28□<V2>	SF4B-H28G□<V2>
Number of beam channels		12		16		20		24		28	
Protective height		230 mm 9.055 in	244 mm 9.606 in	310 mm 12.205 in	324 mm 12.756 in	390 mm 15.354 in	404 mm 15.906 in	470 mm 18.504 in	484 mm 19.055 in	550 mm 21.654 in	564 mm 22.205 in
China Press compliant (GB4584)		220 mm 8.661 in		300 mm 11.811 in		380 mm 14.960 in		460 mm 18.110 in		540 mm 21.260 in	
Current consumption		Emitter: 70 mA or less, Receiver: 95 mA or less						Emitter: 80 mA or less, Receiver: 115 mA or less			
PFHd		1.8 × 10 ⁻⁹		2.0 × 10 ⁻⁹		2.2 × 10 ⁻⁹		2.4 × 10 ⁻⁹		2.6 × 10 ⁻⁹	
MTTFd		100 years or more									
Net weight (Total of emitter and receiver)		510 g approx.	980 g approx.	660 g approx.	1,340 g approx.	810 g approx.	1,700 g approx.	960 g approx.	2,000 g approx.	1,110 g approx.	2,400 g approx.

Type	Min. sensing object ø25 mm ø0.984 in type (20 mm 0.787 in beam pitch)										
Item	Model No. (Note 2)	SF4B-H32□<V2>	SF4B-H32G□<V2>	SF4B-H36□<V2>	SF4B-H36G□<V2>	SF4B-H40□<V2>	SF4B-H40G□<V2>	SF4B-H48□<V2>	SF4B-H48G□<V2>	SF4B-H56□<V2>	SF4B-H56G□<V2>
Number of beam channels		32		36		40		48		56	
Protective height		630 mm 24.803 in	644 mm 25.354 in	710 mm 27.953 in	724 mm 28.504 in	790 mm 31.102 in	804 mm 31.654 in	950 mm 37.402 in	964 mm 37.953 in	1,110 mm 43.701 in	1,124 mm 44.252 in
China Press compliant (GB4584)		620 mm 24.409 in		700 mm 27.559 in		780 mm 30.708 in		940 mm 37.007 in		1,100 mm 43.306 in	
Current consumption		Emitter: 80 mA or less, Receiver: 115 mA or less				Emitter: 90 mA or less, Receiver: 140 mA or less			Emitter: 100 mA or less, Receiver: 160 mA or less		
PFHd		2.8 × 10 ⁻⁹		3.0 × 10 ⁻⁹		3.2 × 10 ⁻⁹		3.6 × 10 ⁻⁹		4.0 × 10 ⁻⁹	
MTTFd		100 years or more									
Net weight (Total of emitter and receiver)		1,260 g approx.	2,800 g approx.	1,420 g approx.	3,200 g approx.	1,570 g approx.	3,400 g approx.	1,870 g approx.	4,200 g approx.	2,170 g approx.	5,000 g approx.

Type	Min. sensing object ø25 mm ø0.984 in type (20 mm 0.787 in beam pitch)										
Item	Model No. (Note 2)	SF4B-H64□<V2>	SF4B-H64G□<V2>	SF4B-H72□<V2>	SF4B-H72G□<V2>	SF4B-H80□<V2>	SF4B-H80G□<V2>	SF4B-H88□<V2>	SF4B-H88G□<V2>	SF4B-H96□<V2>	SF4B-H96G□<V2>
Number of beam channels		64		72		80		88		96	
Protective height		1,270 mm 50.000 in	1,284 mm 50.551 in	1,430 mm 56.299 in	1,444 mm 56.850 in	1,590 mm 62.598 in	1,604 mm 63.150 in	1,750 mm 68.898 in	1,764 mm 69.449 in	1,910 mm 75.197 in	1,924 mm 75.748 in
China Press compliant (GB4584)		1,260 mm 49.606 in		1,420 mm 55.905 in		1,580 mm 62.205 in		1,740 mm 68.503 in		1,900 mm 74.803 in	
Current consumption		Emitter: 100 mA or less, Receiver: 160 mA or less		Emitter: 110 mA or less, Receiver: 180 mA or less				Emitter: 120 mA or less, Receiver: 200 mA or less			
PFHd		4.4 × 10 ⁻⁹		4.8 × 10 ⁻⁹		5.2 × 10 ⁻⁹		5.6 × 10 ⁻⁹		6.0 × 10 ⁻⁹	
MTTFd		100 years or more									
Net weight (Total of emitter and receiver)		2,470 g approx.	5,600 g approx.	2,770 g approx.	6,400 g approx.	3,070 g approx.	7,000 g approx.	3,370 g approx.	7,800 g approx.	3,670 g approx.	8,400 g approx.

Notes: 1) Where measurement conditions have not been specified precisely, the conditions used were an ambient temperature of +20 °C +68 °F. The model No. with "G" is a robust type.
2) The models with the "-01" or "-03" cannot be used with the handy-controller **SFB-HC**.

SPECIFICATIONS

SF4B-A□(G)<V2>

Type	Min. sensing object $\varnothing 45$ mm $\varnothing 1.772$ in type (40 mm 1.575 in beam pitch)										
Item	Model No. (Note 2)	SF4B-A6□<V2>	SF4B-A6G<V2>	SF4B-A8□<V2>	SF4B-A8G<V2>	SF4B-A10□<V2>	SF4B-A10G<V2>	SF4B-A12□<V2>	SF4B-A12G<V2>	SF4B-A14□<V2>	SF4B-A14G<V2>
Number of beam channels		6		8		10		12		14	
Protective height		230 mm 9.055 in	244 mm 9.606 in	310 mm 12.205 in	324 mm 12.756 in	390 mm 15.354 in	404 mm 15.906 in	470 mm 18.504 in	484 mm 19.055 in	550 mm 21.654 in	564 mm 22.205 in
China Press compliant (GB4584)		200 mm 7.874 in		280 mm 11.024 in		360 mm 14.173 in		440 mm 17.323 in		520 mm 20.472 in	
Current consumption		Emitter: 65 mA or less, Receiver: 85 mA or less						Emitter: 70 mA or less, Receiver: 95 mA or less			
PFHd		1.5×10^{-9}		1.6×10^{-9}		1.7×10^{-9}		1.8×10^{-9}		1.9×10^{-9}	
MTTFd		100 years or more									
Net weight (Total of emitter and receiver)		510 g approx.	980 g approx.	660 g approx.	1,340 g approx.	810 g approx.	1,700 g approx.	960 g approx.	2,000 g approx.	1,110 g approx.	2,400 g approx.

Type	Min. sensing object $\varnothing 45$ mm $\varnothing 1.772$ in type (40 mm 1.575 in beam pitch)										
Item	Model No. (Note 2)	SF4B-A16□<V2>	SF4B-A16G<V2>	SF4B-A18□<V2>	SF4B-A18G<V2>	SF4B-A20□<V2>	SF4B-A20G<V2>	SF4B-A24□<V2>	SF4B-A24G<V2>	SF4B-A28□<V2>	SF4B-A28G<V2>
Number of beam channels		16		18		20		24		28	
Protective height		630 mm 24.803 in	644 mm 25.354 in	710 mm 27.953 in	724 mm 28.504 in	790 mm 31.102 in	804 mm 31.654 in	950 mm 37.402 in	964 mm 37.953 in	1,110 mm 43.701 in	1,124 mm 44.252 in
China Press compliant (GB4584)		600 mm 23.622 in		680 mm 26.772 in		760 mm 29.921 in		920 mm 36.220 in		1,080 mm 42.520 in	
Current consumption		Emitter: 70 mA or less, Receiver: 95 mA or less				Emitter: 75 mA or less, Receiver: 105 mA or less				Emitter: 80 mA or less, Receiver: 120 mA or less	
PFHd		2.0×10^{-9}		2.1×10^{-9}		2.2×10^{-9}		2.4×10^{-9}		2.6×10^{-9}	
MTTFd		100 years or more									
Net weight (Total of emitter and receiver)		1,260 g approx.	2,800 g approx.	1,420 g approx.	3,200 g approx.	1,570 g approx.	3,400 g approx.	1,870 g approx.	4,200 g approx.	2,170 g approx.	5,000 g approx.

Type	Min. sensing object $\varnothing 45$ mm $\varnothing 1.772$ in type (40 mm 1.575 in beam pitch)										
Item	Model No. (Note 2)	SF4B-A32□<V2>	SF4B-A32G<V2>	SF4B-A36□<V2>	SF4B-A36G<V2>	SF4B-A40□<V2>	SF4B-A40G<V2>	SF4B-A44□<V2>	SF4B-A44G<V2>	SF4B-A48□<V2>	SF4B-A48G<V2>
Number of beam channels		32		36		40		44		48	
Protective height		1,270 mm 50.000 in	1,284 mm 50.551 in	1,430 mm 56.299 in	1,444 mm 56.850 in	1,590 mm 62.598 in	1,604 mm 63.150 in	1,750 mm 68.898 in	1,764 mm 69.449 in	1,910 mm 75.197 in	1,924 mm 75.748 in
China Press compliant (GB4584)		1,240 mm 48.819 in		1,400 mm 55.118 in		1,560 mm 61.417 in		1,720 mm 67.716 in		1,880 mm 74.016 in	
Current consumption		Emitter: 80 mA or less, Receiver: 120 mA or less		Emitter: 85 mA or less, Receiver: 130 mA or less				Emitter: 95 mA or less, Receiver: 140 mA or less			
PFHd		2.8×10^{-9}		3.0×10^{-9}		3.2×10^{-9}		3.4×10^{-9}		3.6×10^{-9}	
MTTFd		100 years or more									
Net weight (Total of emitter and receiver)		2,470 g approx.	5,600 g approx.	2,770 g approx.	6,400 g approx.	3,070 g approx.	7,000 g approx.	3,370 g approx.	7,800 g approx.	3,670 g approx.	8,400 g approx.

Notes: 1) Where measurement conditions have not been specified precisely, the conditions used were an ambient temperature of +20 °C +68 °F. The model No. with "G" is a robust type.
2) The models with the "-01" or "-03" cannot be used with the handy-controller SFB-HC.

SPECIFICATIONS

Light curtain common specifications

Type	Min. sensing object ø14 mm $\phi 0.551$ in type	Min. sensing object ø25 mm $\phi 0.984$ in type	Min. sensing object ø45 mm $\phi 1.772$ in type
Model No.	SF4B-F□(G)<V2>	SF4B-H□(G□)<V2>	SF4B-A□(G)<V2>
SFB-HC non-compatible	SF4B-F□-01<V2>	SF4B-H□-01<V2>	SF4B-A□-01<V2>
Korean press compliant	SF4B-F□-03<V2>	SF4B-H□-03<V2>	—
Applicable standards (Note 2)	International standard	IEC 61496-1/2 (Type 4), ISO 13849-1 (Category 4, PLe), IEC 61508-1 to 7 (SIL3)	
	Japan	JIS B 9704-1/2 (Type 4), JIS B 9705-1 (Category 4), JIS C 0508-1 to 7 (SIL3)	
	Europe (EU)	EN 61496-1 (Type 4), EN ISO 13849-1 (Category 4, PLe), EN 61508-1 to 7 (SIL3), EN 55011, EN 50178, EN 61000-6-2	
	North America	ANSI/UL 61496-1/2 (Type 4), ANSI/UL 508, UL 1998 (Class 2), CAN/CSA 61496-1/2 (Type 4), CAN/CSA C22.2 No.14, OSHA 1910.212, OSHA 1910.217(C), ANSI B11.1 to B11.19, ANSI/RIA 15.06	
	South Korea (S-Mark)	S1-G-35-2005, S2-W-11-2003 (SF4B-□<V2> only)	
	China (GB)	GB 4584 (excluding SF4B-□-03<V2>)	
	Operating range (Note 3)	0.3 to 7 m 0.984 to 22.966 ft	12 to 64 beam channels type: 0.3 to 9 m 0.984 to 29.528 ft 72 to 96 beam channels type: 0.3 to 7 m 0.984 to 22.966 ft
Min. sensing object (Note 4)	ø14 mm $\phi 0.551$ in opaque object	ø25 mm $\phi 0.984$ in opaque object	ø45 mm $\phi 1.772$ in opaque object
Effective aperture angle	$\pm 2.5^\circ$ or less [for an operating range exceeding 3 m 9.843 ft (conforming to IEC 61496-2 / UL 61496-2)]		
Supply voltage	24 V DC $\pm 10\%$ Ripple P-P 10 % or less		
Control outputs (OSSD 1, OSSD 2)	PNP open-collector transistor / NPN open-collector transistor (switching method)		
	<ul style="list-style-type: none"> When selecting PNP output: Max. source current 200 mA, When selecting NPN output: Max. sink current 200 mA Applied voltage: same as supply voltage (When selecting PNP output: between the control output and +V,) (When selecting NPN output: between the control output and 0 V) Residual voltage: 2.5 V or less (When selecting PNP output: source current 200 mA, when selecting NPN output: sink current 200 mA) (when using 20 m 65.617 ft length cable) 		
	Operation mode	ON when all beam channels are received, OFF when one or more beam channels are interrupted (OFF also in case of any malfunction in the light curtain or the synchronization signal)(Note 5,6)	
Protection circuit	Incorporated		
Response time	OFF response: 14 ms or less, ON response: 80 to 90 ms		
Auxiliary output (Non-safety output)	PNP open-collector transistor / NPN open-collector transistor (switching method)		
	<ul style="list-style-type: none"> When selecting PNP output: Max. source current 60 mA, When selecting NPN output: Max. sink current 60 mA Applied voltage: same as supply voltage (When selecting PNP output: between the auxiliary output and +V,) (When selecting NPN output: between the auxiliary output and 0 V) Residual voltage: 2.5 V or less (When selecting PNP output: source current 60 mA, when selecting NPN output: sink current 60 mA) (when using 20 m 65.617 ft length cable) 		
	Operation mode	OFF when control outputs are ON, ON when control outputs are OFF [Factory setting, operating mode can be changed using the SFB-HC handy-controller (optional)].	
	Protection circuit	Incorporated	
Response time	OFF replay: 34 ms or less, ON replay 110 ms or less		
Interference prevention function	Incorporated (Note 7) (Available only when in series connection for SF4B-□-03<V2>)		
Emission halt function / Interlock function	Incorporated / Incorporated [Manual reset / Auto reset (Note 8)]		
External device monitoring function	Incorporated		
Override function / Muting function	Incorporated (Note 7) (excluding SF4B-□-03<V2>) / Incorporated (Note 7) (excluding SF4B-□-03<V2>)		
Optional functions (Note 9)	Fixed blanking, floating blanking, auxiliary output switching, interlock setting changing, external relay monitor setting changing, muting setting changing, protecting, light emitting amount control		
Environmental resistance	Degree of protection	IP67 / IP65 (IEC)	
	Ambient temperature	-10 to +55 °C +14 to +131 °F (No dew condensation or icing allowed), Storage: -25 to +70 °C -13 to +158 °F	
	Ambient humidity	30 to 85 % RH, Storage: 30 to 95 % RH	
	Ambient illuminance	Incandescent light: 3,500 lx or less at the light-receiving face	
	Dielectric strength voltage	1,000 V AC for one min. between all supply terminals connected together and enclosure	
	Insulation resistance	20 MΩ, or more, with 500 V DC megger between all supply terminals connected together and enclosure	
	Vibration resistance	10 to 55 Hz frequency, 0.75 mm 0.030 in amplitude in X, Y and Z directions for two hours each	
	Shock resistance	300 m/s ² acceleration (30 G approx.) in X, Y and Z directions for three times each	
Emitting element	Infrared LED (Peak emission wavelength: 870 nm 0.034 mil)		
Material	Enclosure: Aluminium, Upper and lower edges: Iron, Sensing surface: Polycarbonate and Polyester resin, Cap: PBT		
Connecting method / Cable length	Connector / Total length up to 50 m 164.042 ft is possible for both emitter and receiver, with optional mating cables (Note 10)		
Accessories	MS-SFB-2 (Intermediate supporting bracket): (Note 11)	MS-SFB-2 (Intermediate supporting bracket): (Note 11)	MS-SFB-2 (Intermediate supporting bracket): (Note 11)
	MS-SF4BG-2 (Intermediate supporting bracket): (Note 12) SF4B-TR14 (Test rod): 1 No.	MS-SF4BG-2 (Intermediate supporting bracket): (Note 12) SF4B-TR25 (Test rod): 1 No.	MS-SF4BG-2 (Intermediate supporting bracket): (Note 12) MS-SF4BG-2 (Intermediate supporting bracket): (Note 12)

- Notes: 1) Where measurement conditions have not been specified precisely, the conditions used were an ambient temperature of +20 °C **+68 °F**.
2) PLe SIL3 compliant from production in August 2009. Model Nos. having the suffix "G" are robust type.
3) The operating range is the possible setting distance between the emitter and the receiver.
4) When the floating blanking function is used, the size of the min. sensing object is changed. For details, refer to "Safety distance" (p.36~).
5) The outputs are not "OFF" when muting function is active even if the beam channel is interrupted.
6) In case the blanking function is valid, the operation mode is changed. For details, refer to "Safety distance" (p.36~).
7) In case of using this function, please use 12-core cable.
8) The manual reset and auto reset are possible to be switched depending on the wiring status.
9) In case of using optional function, the handy-controller (**SFB-HC**) (optional) is required. However, a handy-controller cannot be used with the **SF4B-□-01<V2>**, **SF4B-□-03<V2>** and the **SF-C14EX-01**.
10) The cable can be extended within 30 m **98.425 ft** (for emitter / receiver) when two light curtains are connected in series, within 20 m **65.617 ft** when three light curtains are connected in series. Furthermore, when the muting lamp is used, the cable can be extended within 40 m **131.234 ft** (for emitter / receiver).
11) The intermediate supporting bracket (**MS-SFB-2**) is enclosed with the following models. The number of sets required varies depending on the product.
1 set: **SF4B-F□<V2>** Light curtain with 79 to 111 beam channels, **SF4B-H□<V2>** Light curtain with 40 to 56 beam channels, **SF4B-A□<V2>** Light curtain with 20 to 28 beam channels
2 sets: **SF4B-F127<V2>**, **SF4B-H□<V2>**...Light curtain with 64 to 80 beam channels, **SF4B-A□<V2>**...Light curtain with 32 to 40 beam channels
3 sets: **SF4B-H□<V2>** Light curtain with 88 to 96 beam channels, **SF4B-A□<V2>** Light curtain with 44 to 48 beam channels
12) The intermediate supporting bracket (**MS-SF4BG-2**) is enclosed with the following models.
1 set: **SF4B-F□G<V2>** Light curtain with 79 to 127 beam channels, **SF4B-H□G□<V2>** Light curtain with 40 to 64 beam channels
SF4B-A□G□<V2> Light curtain with 20 to 32 beam channels
2 sets: **SF4B-H□G□<V2>** Light curtain with 72 to 96 beam channels, **SF4B-A□G□<V2>** Light curtain with 36 to 48 beam channels

SPECIFICATIONS

Control units

Item	Model No.	SF-C11 (Note 2)	SF-C12	SF-C13 (Note 2)
Connectable light curtains		SF4B / SF2B series	SF4B series	Light curtains manufactured by Panasonic Industrial Devices SUNX
Applicable standards		IEC 61496-1, EN 61496-1, ANSI/UL 61496-1, CAN/CSA 61496-1, JIS B 9704-1		
Control category		ISO 13849-1 (EN ISO 13849-1, JIS B 9705-1) compliance up to Category 4, PLe standards		
Supply voltage / Current consumption		24 V DC $\pm 10\%$ Ripple P-P 10% or less / 100 mA or less (excluding light curtain)		
Fuse (rating)		Built-in electronic fuse, Triggering current: 0.5 A or more, Reset after power down		
Enabling path		NO contact $\times 3$ (13-14, 23-24, 33-34)	NO contact $\times 2$ (13-14, 23-24)	NO contact $\times 3$ (13-14, 23-24, 33-34)
Utilization category		AC-15, DC-13 (IEC 60947-5-1)		
Rated operation voltage (Ue) / Rated operation current (Ie)		30 V DC / 6 A, 230 V AC / 6 A, resistive load (For inductive load, during contact protection) Min. applicable load: 10 mA (at 24 V DC) (Note 3)	24 V DC / 1 A, resistive load (For inductive load, during contact protection) Min. applicable load: 15 mA (at 24 V DC)	30 V DC / 4 A, 230 V AC / 4 A, resistive load (For inductive load, during contact protection) Min. applicable load: 10 mA (at 24 V DC) (Note3)
Contact resistance		100 m Ω or less (initial value)	50 m Ω or less (initial value)	100 m Ω or less (initial value)
Contact protection fuse rating		6 A (slow blow)	3 A (slow blow)	4 A (slow blow)
Pick-up delay (Auto reset / Manual reset)		80 ms or less / 90 ms or less	30 ms or less / 30 ms or less	80 ms or less / 90 ms or less
Response time		10 ms or less	14 ms or less	10 ms or less
Auxiliary output		Safety relay contact (NC contact) $\times 1$ (41-42) (Related to enabling path)	Safety relay contact (NC contact) $\times 1$ (31-32) (Related to enabling path)	Safety relay contact (NC contact) $\times 1$ (41-42) (Related to enabling path)
Rated operation voltage / current		24 V DC / 2 A, Min. applicable load: 10 mA (at 24 V DC)	30 V DC / 3 A, Min. applicable load: 15 mA (at 24 V DC)	24 V DC / 2 A, Min. applicable load: 10 mA (at 24 V DC)
Contact protection fuse rating		2 A (slow blow)	3 A (slow blow)	2 A (slow blow)
Semiconductor auxiliary output (AUX)		<Minus ground (Setting for PNP)> PNP open-collector transistor <Plus ground (Setting for NPN)> NPN open-collector transistor	—	PNP open-collector transistor
Output operation		Related to auxiliary output of light curtain	—	ON when the light curtain is interrupted
Excess voltage category		II	III	II
Polarity selection function (Note 4)		Incorporated (Sliding switch allows selection of plus / minus ground) Minus ground: Correspond to PNP output light curtain Plus ground: Correspond to NPN output light curtain	—	Incorporated (Cable connection allows selection of plus / minus ground) Minus ground: Correspond to PNP output light curtain Plus ground: Correspond to NPN output light curtain
Pollution degree		2		
Protection		Enclosure: IP40, Terminal: IP20	IP65	Enclosure: IP40, Terminal: IP20
Ambient temperature		-10 to +55 °C +14 to +131 °F (No dew condensation or icing allowed), Storage: -25 to +70 °C -13 to +158 °F		
Enclosure material		ABS	Die-cast aluminum	ABS
Weight		Net weight: 320 g approx.	Net weight: 1 kg approx.	Net weight: 200 g approx.

- Notes: 1) Where measurement conditions have not been specified precisely, the conditions used were an ambient temperature of +20 °C +68 °F.
 2) SF-C11 and SF-C13 have acquired the Korea S-mark.
 3) If several SF-C11 or SF-C13 units are being used in a line together, leave a space of 5 mm 0.197 in or more between each unit. If the units are touching each other, reduce the rated operating current for safety output in accordance with the ambient operating temperature as shown in the graphs at right.
 4) Please switch the sliding switch to the PNP side for minus ground and to the NPN side for plus ground.
 5) For details of control unit SF-C1□ (SF-C10 series), refer to the website or general catalog.

Dilating when SF-C11 units are mounted close together

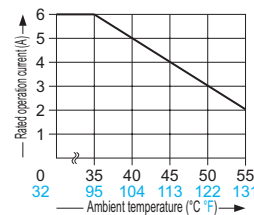

Dilating when SF-C13 units are mounted close together

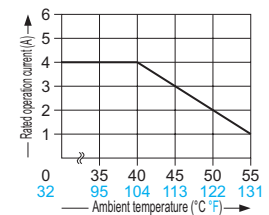

Item	Model No.	SF-C14EX(-01) (Note 2)
Connectable light curtains		SF4B series
Applicable standards		IEC 61496-1, EN 61496-1, ANSI/UL 61496-1, CAN/CSA 61496-1, JIS B 9704-1
Control category		ISO 13849-1 (EN ISO 13849-1, JIS B 9705-1) compliance up to Category 4, PLe standards
Supply voltage / Current consumption		24 V DC $\pm 10\%$ Ripple P-P 10% or less / 0.2 A or less (Excluding light curtain and other external connecting device)
Enabling path (Enabling path 1, 2, 3)		PNP open-collector transistor 2 outputs $\times 3$ or NPN open-collector transistor 2 outputs $\times 3$ (selectable using a slider switch)
Operation mode (Output operation)		Enabling path 1: ON when the light curtain is in light receiving condition, OFF when the light curtain is in light interrupted condition (Note 3) Enabling path 2: ON when the light curtain is in light receiving condition or the muting function is valid OFF when the light curtain is in light interrupted condition and the muting function is invalid (Note 3) Enabling path 3: ON when the emergency stop is invalid, OFF when the emergency stop is valid
Response time		OFF response: 14 ms or less (Enabling path 1 and 2: including the response time of the light curtain) ON response: 90 ms or less (auto-reset) / 140 ms or less (manual reset) (Note 4)
Auxiliary outputs (Auxiliary output 1, 2, 3, 4) (Note 5)		PNP open-collector transistor $\times 3$ or NPN open-collector transistor $\times 3$ (selectable using a slider switch) <When PNP output is selected> <ul style="list-style-type: none"> Maximum source current: 60 mA or less Applied voltage: same as supply voltage (between the auxiliary output and +V) Residual voltage: 2 V or less (at 60 mA source current) <When NPN output is selected> <ul style="list-style-type: none"> Maximum sink current: 60 mA or less Applied voltage: same as supply voltage (between the auxiliary output and 0 V) Residual voltage: 2 V or less (at 60 mA sink current)
Operation mode (Output operation)		Auxiliary output 1: ON when the muting function is invalid, OFF when the muting function is valid Auxiliary output 2: ON when the override function is invalid, OFF when the override function is valid Auxiliary output 3: ON when the muting lamp is normal, OFF when the muting lamp is error Auxiliary output 4: ON when the light curtain is in light interrupted condition, OFF when the light curtain is in light receiving condition (Note 5)
Muting lamp output		Applicable muting lamp: 24 V DC, 3.6 to 30 W (L1, L2 of each unit)
Protection		Enclosure: IP40, Terminal: IP20
Ambient temperature		-10 to +55 °C +14 to +131 °F (No dew condensation or icing allowed), Storage: -25 to +70 °C -13 to +158 °F
Material		Enclosure: ABS
Connection terminal		Detachable spring-cage terminal
Weight		Net weight: 250 g approx.

- Notes: 1) Where measurement conditions have not been specified precisely, the conditions used were an ambient temperature of +20 °C +68 °F.
 2) SF-C14EX-01 is Handy-controller non-compatible type.
 3) Both enabling path 1 and 2 are OFF when the emergency stop is valid regardless of whether the light curtain is in the light receiving or light interrupted condition.
 4) The auto-reset cannot be used with enabling path 3.
 5) The auxiliary output incorporated in the SF4B series is outputted.
 6) For details of control unit SF-C14EX(-01), refer to the website or general catalog.

SPECIFICATIONS

Handy-controller

Model No.	SFB-HC
Item	
Supply voltage	24 V DC $\pm 10\%$ Ripple P-P10 % or less (common to light curtain power supply)
Current consumption	65 mA or less
Communication method	RS-485 two-way communications (Specific procedure)
Digital display	4-digit red LED display $\times 2$ (Selected beam channels, setting contents etc. are displayed.)
Function indicator	Green LED $\times 9$ (set function is displayed.)
Functions	Fixed blanking (Factory setting: Disabled) / Floating blanking (Factory setting: Disabled) / Auxiliary output change (Factory setting: Negative Logic of OSSD) / Light emitting amount control (Factory setting: Disabled) / Muting setting change [Factory setting: All beam channels enabled, A = B, Setting of the muting lamp diagnosis function enabled (Ver. 2 or later), Muting sensor output operation setting N.O. / N.C. (Ver. 2.1 or later)] / Interlock setting change (Factory setting: start / restart) / External device monitoring setting change (Factory setting: Enabled, 300 ms) / Override setting changing function 60 sec. (Ver. 2.1 or later) / Setting detail monitoring / Protecting (Factory setting: Disabled)(Factory password setting: 0000) / Initialization / Copy
Ambient temperature	-10 to +55 °C +14 to +131 °F (No dew condensation or icing allowed), Storage: -25 to +70 °C -13 to +158 °F
Ambient humidity	30 to 85 % RH, Storage: 30 to 85 % RH
Voltage withstandability	1,000 V AC for one min. between all supply terminals connected together and enclosure
Insulation resistance	20 M Ω , or more, with 500 V DC megger between all supply terminals connected together and enclosure
Cable	8-core shielded cable, 0.5 m 1.640 ft long, with a connector at the end (2 cables)
Material	Enclosure: ABS
Weight	Net weight: 200 g approx.
Accessories	Adapter cable: 2 cables

Note: Where measurement conditions have not been specified precisely, the conditions used were an ambient temperature of +20 °C +68 °F.

Laser alignment tool

Model No.	SF-LAT-2N / SF-LAT-4BG (For SF4B-□G□)
Item	
Supply voltage	3 V (LR6 battery $\times 2$ pcs.)
Battery	1.5 V (LR6 battery) $\times 2$ pcs. (replaceable)
Battery lifetime	30 hours approx. of continuous operation (LR6 battery, at +25 °C +77 °F ambient temperature)
Light source	Red semiconductor laser: Class 2 (IEC / JIS / FDA) (Max. output: 1 mW, Peak emission wavelength: 650 nm 0.026 mil) (Note 2)
Spot diameter	10 mm 0.394 in approx. (at 5 m 16.404 ft distance)
Ambient temperature	0 to +40 °C +32 to +104 °F (No dew condensation), Storage: 0 to +55 °C +32 to +131 °F
Ambient humidity	35 to 85 % RH, Storage: 35 to 85 % RH
Material	Enclosure: ABS, Mounting part: Aluminum
Weight	Net weight: 200 g approx. (including batteries)
Accessories	LR6 battery: 2 pcs.

Notes: 1) Where measurement conditions have not been specified precisely, the conditions used were an ambient temperature of +20 °C +68 °F.

2) As for FDA regulation, the product complies with 21 CFR 1040.10 and 1040.11 based on Laser Notice No. 50, dated June 24, 2007, issued by CDRH under the FDA.

Corner mirror

Model No.	RF-SFBH-□	
Item		
Attenuation rate of sensing range	With one mirror: Declined to 90 %, With two mirrors: Declined to 80 % (When used in combination with the SF4B series)	
Environmental resistance	Ambient temperature	-10 to +55 °C +14 to +131 °F (No dew condensation or icing allowed), Storage: -25 to +70 °C -13 to +158 °F
	Ambient humidity	30 to 85 % RH, Storage: 30 to 95 % RH
	Vibration resistance	10 to 55 Hz frequency, 0.75 mm 0.030 in amplitude in X, Y and Z directions for two hours each
	Shock resistance	300 m/s ² acceleration (30 G approx.) in X, Y and Z directions for three times each
Material	Enclosure: Aluminium, Mounting bracket: Stainless steel, Mirror (rear surface mirror): Glass, Side cover: EPDM	
Accessories	Intermediate supporting bracket: 1 set (RF-SFBH-40/48/56/64), 2 sets (RF-SFBH-72/80/88/96)	

Note: Where measurement conditions have not been specified precisely, the conditions used were an ambient temperature of +20 °C +68 °F.

I/O circuit diagram

In case of using I/O circuit for PNP output

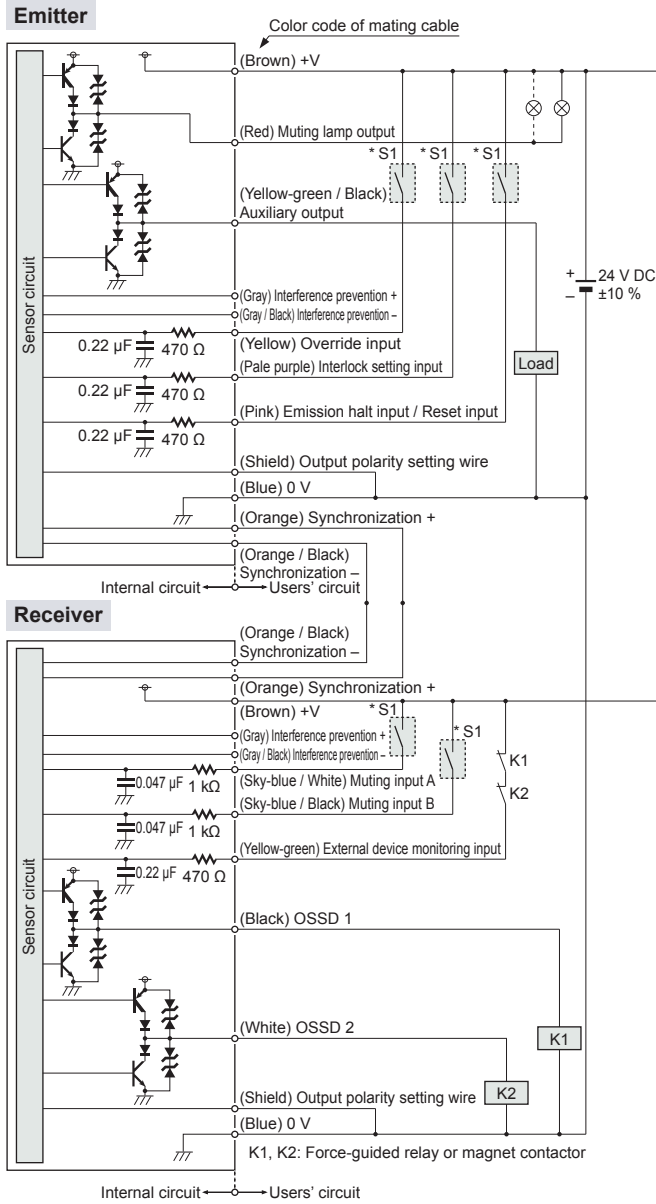

Note: The above diagram is when using a 12-core cable. If an 8-core cable is used, the red, yellow, gray, gray / black, sky-blue / white and sky-blue / black lead wires are absent.

* S1

Switch S1

- Emission halt input / Reset input
For manual reset
Vs to Vs - 2.5 V (sink current 5 mA or less): Emission halt (Note 1)
Open: Emission
- For automatic reset
Vs to Vs - 2.5 V (sink current 5 mA or less): Emission (Note 1)
Open: Emission halt
- Interlock setting input, Override input, Muting input A / B, External device monitoring input
Vs to Vs - 2.5 V (sink current 5 mA or less): Enabled (Note 1)
Open: Disabled

Note: Vs is the applying supply voltage.

In case of using I/O circuit for NPN output

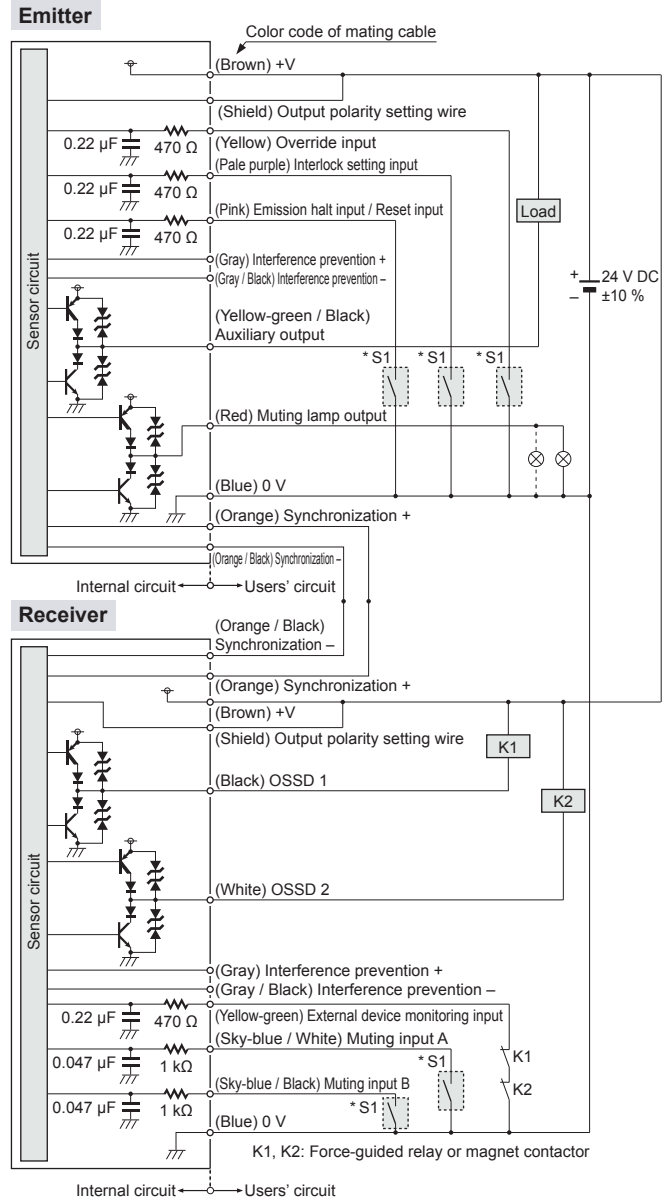

Note: The above diagram is when using a 12-core cable. If an 8-core cable is used, the red, yellow, gray, gray / black, sky-blue / white and sky-blue / black lead wires are absent.

* S1

Switch S1

- Emission halt input / Reset input
For manual reset
0 to +1.5 V (source current 5 mA or less): Emission halt
Open: Emission
- For automatic reset
0 to +1.5 V (source current 5 mA or less): Emission
Open: Emission halt
- Interlock setting input, Override input, Muting input A / B, External device monitor input
0 to +1.5 V (source current 5 mA or less): Enabled
Open: Disabled

Connection example

Standard components (8-core cable): Interlock function “enabled (manual reset)”, external device monitoring function “enabled”

In case of using I/O circuit for PNP output

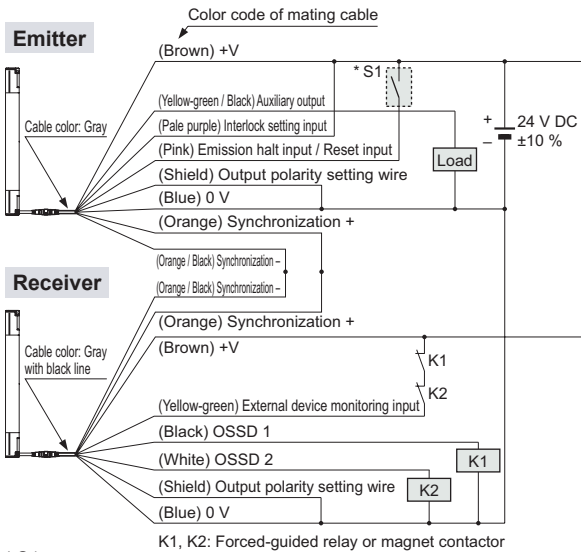

Switch S1

- Emission halt input / Reset input
- For manual reset
- Vs to Vs - 2.5 V (sink current 5 mA or less): Emission halt (Note)
- Open: Emission
- For automatic reset
- Vs to Vs - 2.5 V (sink current 5 mA or less): Emission (Note)
- Open: Emission halt

Note: Vs is the applying supply voltage.

In case of using I/O circuit for NPN output

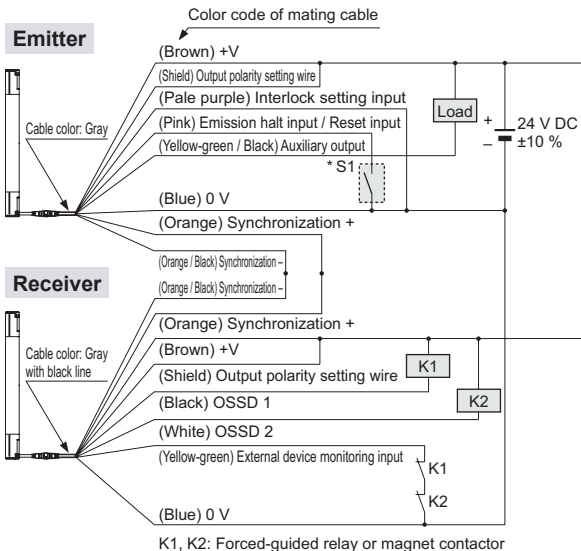

Switch S1

- Emission halt input / Reset input
- For manual reset
- 0 to +1.5 V (source current 5 mA or less): Emission halt
- Open: Emission
- For automatic reset
- 0 to +1.5 V (source current 5 mA or less): Emission
- Open: Emission halt

The diagram at left shows the configuration when using PNP output, interlock function “enabled (manual reset)” and external device monitoring function “enabled”.

In case of setting the interlock function to “disabled (automatic reset)”

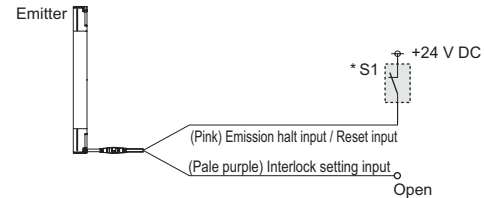

* Refer to the SF4B<V2> manual for details of the interlock function.

In case of setting the external device monitoring function to “disabled”

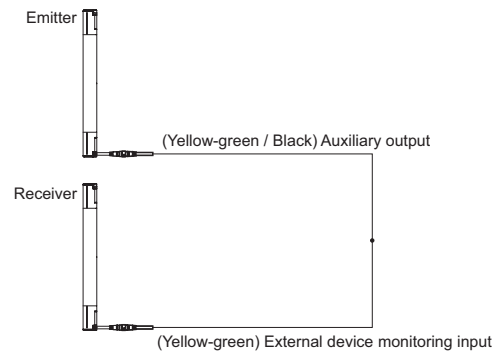

* Refer to the SF4B<V2> manual for details of the external device monitoring function.

The diagram at left shows the configuration when using NPN output, interlock function “enabled (manual reset)” and external device monitoring function “enabled”.

In case of setting the interlock function to “disabled (automatic reset)”

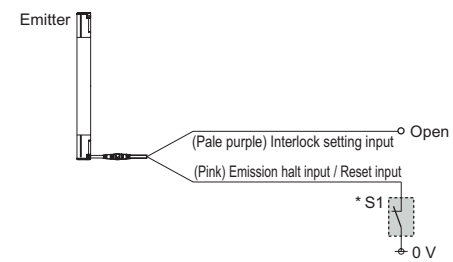

* Refer to the SF4B<V2> manual for details of the interlock function.

In case of setting the external device monitoring function to “disabled”

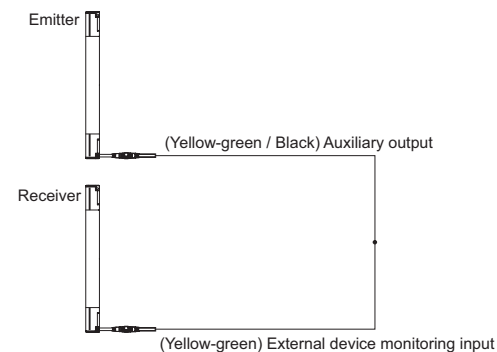

* Refer to the SF4B<V2> manual for details of the external device monitoring function.