



Chipsmall Limited consists of a professional team with an average of over 10 year of expertise in the distribution of electronic components. Based in Hongkong, we have already established firm and mutual-benefit business relationships with customers from,Europe,America and south Asia,supplying obsolete and hard-to-find components to meet their specific needs.

With the principle of "Quality Parts,Customers Priority,Honest Operation,and Considerate Service",our business mainly focus on the distribution of electronic components. Line cards we deal with include Microchip,ALPS,ROHM,Xilinx,Pulse,ON,Everlight and Freescale. Main products comprise IC,Modules,Potentiometer,IC Socket,Relay,Connector.Our parts cover such applications as commercial,industrial, and automotives areas.

We are looking forward to setting up business relationship with you and hope to provide you with the best service and solution. Let us make a better world for our industry!



Contact us

Tel: +86-755-8981 8866 Fax: +86-755-8427 6832

Email & Skype: info@chipsmall.com Web: www.chipsmall.com

Address: A1208, Overseas Decoration Building, #122 Zhenhua RD., Futian, Shenzhen, China



SF2098E

915 MHz SAW Filter

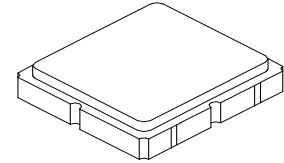

SM3030-6

- Low-loss 915 MHz SAW Filter
- Designed for 50 ohm Source/Load
- Complies with Directive 2002/95/EC (RoHS)



Absolute Maximum Ratings

Rating	Value	Units
Input Power Level	+15	dBm
DC Voltage on any Non-ground Terminal	5	V
Operating Temperature Range	-40 to +125	°C
Component Storage Temperature Range	-40 to +125	°C
Storage Temperature Range in Tape and Reel	-40 to +85	°C
Maximum Soldering Profile, 5 cycles/10 seconds maximum	265	°C
Temperature Coefficient of Frequency	-36	ppm/°C

Electrical Characteristics

Characteristic (Operating Temperature -40°C to +85°C)	Sym	Notes	Min	Typ	Max	Units
Center Frequency	f_c			915		MHz
Insertion Loss, 902 to 928 MHz	IL			1.9	4.0	0
Amplitude Ripple, 902 to 928 MHz				1.0	3.2	dB
VSWR, 902 to 928 MHz				1.8:1	2.2:1	
Attenuation, Referenced to 0 dB:						dB
10 to 800 MHz			35	37		
800 to 888 MHz at 25°C			36	38		
800 to 888 MHz at -40°C to +85°C			29	38		
888 to 890 MHz 25°C			24	31		
888 to 890 MHz at -40°C to +85°C			22	31		
890 to 894 MHz			5	18		
940 to 941 MHz			27	47		
941 to 967 MHz			35	49		
967 to 1350 MHz			37	39		
1350 to 1600 MHz			35	42		
1600 to 2000 MHz			30	45		
2000 to 2500 MHz			28	35		
Source Impedance	Z_S			50		Ω
Load Impedance	Z_L			50		Ω

Case Style	SM3030-6 3.0 x 3.0 mm Nominal Footprint
Lid Symbolization (Y=year, WW=week, S=shift) dot=pin 1 indicator	A66, YWWS
Standard Reel Quantity, 7 inch Reel Size	500 Pieces/Reel
Standard Reel Quantity, 13 inch Reel Size	3000 Pieces/Reel

CAUTION: Electrostatic Sensitive Device. Observe precautions for handling.

NOTES:

1. Unless noted otherwise, all specifications apply over the operating temperature range with filter soldered to the specified demonstration board with impedance matching to 50 Ω and measured with 50 Ω network analyzer.
2. Unless noted otherwise, all frequency specifications are referenced to the nominal center frequency, f_c .
3. Rejection is measured as attenuation below the minimum IL point in the passband. Rejection in final user application is dependent on PCB layout and external impedance matching design. See Application Note No. 42 for details.
4. "LRIP" or "L" after the part number indicates "low rate initial production" and "ENG" or "E" indicates "engineering prototypes."
5. The design, manufacturing process, and specifications of this filter are subject to change.
6. Either Port 1 or Port 2 may be used for either input or output in the design. However, impedances and impedance matching may vary between Port 1 and Port 2, so that the filter must always be installed in one direction per the circuit design.
7. US and international patents may apply.
8. Murata, stylized Murata logo, and Murata N.A., Inc. are registered trademarks of Murata Manufacturing Co., Ltd.

Electrical Characteristics

Characteristic (Operating Temperature -40°C to +125°C)	Sym	Notes	Min	Typ	Max	Units
Center Frequency	f_c			915		MHz
Insertion Loss, 902 to 928 MHz	IL			1.9	4.5	dB
Amplitude Ripple, 902 to 928 MHz				1.0	3.7	dB
VSWR, 902 to 928 MHz				1.8:1	2.5:1	
Attenuation, Referenced to 0 dB:						dB
10 to 800 MHz			35	37		
800 to 888 MHz at 25°C			36	38		
800 to 888 MHz at -40°C to +125°C			15	38		
888 to 890 MHz 25°C			24	31		
888 to 890 MHz at -40°C to +125°C			10	31		
940 to 941 MHz			27	47		
941 to 967 MHz			35	49		
967 to 1350 MHz			37	39		
1350 to 1600 MHz			35	42		
1600 to 2000 MHz			30	45		
2000 to 2500 MHz			28	35		
Source Impedance	Z_s			50		Ω
Load Impedance	Z_L			50		Ω
Case Style	SM3030-6 3.0 x 3.0 mm Nominal Footprint					
Lid Symbolization (Y=year, WW=week, S=shift) dot=pin 1 indicator	A66, YWWS					
Standard Reel Quantity, 7 inch Reel Size	500 Pieces/Reel					
Standard Reel Quantity, 13 inch Reel Size	3000 Pieces/Reel					

Electrical Connections

Connection	Terminals
Input	2
Output	5
Case Ground	All others

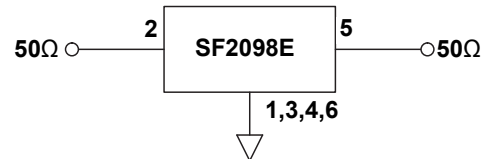

Filter Response Plots

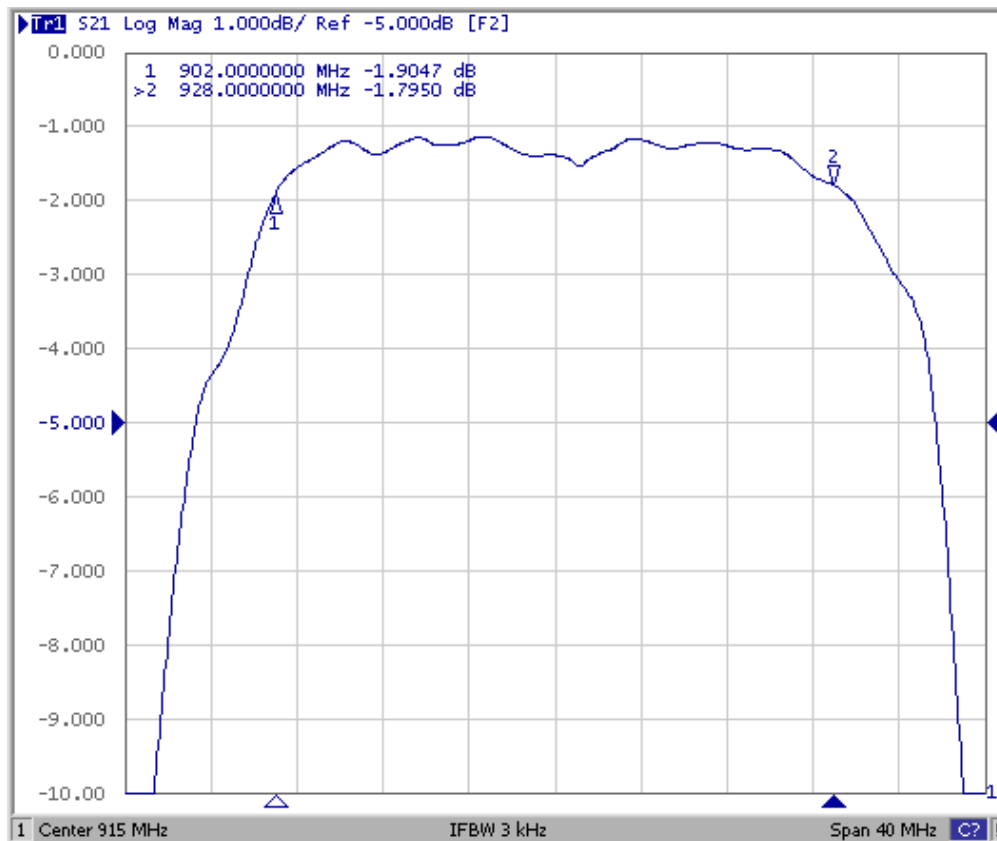
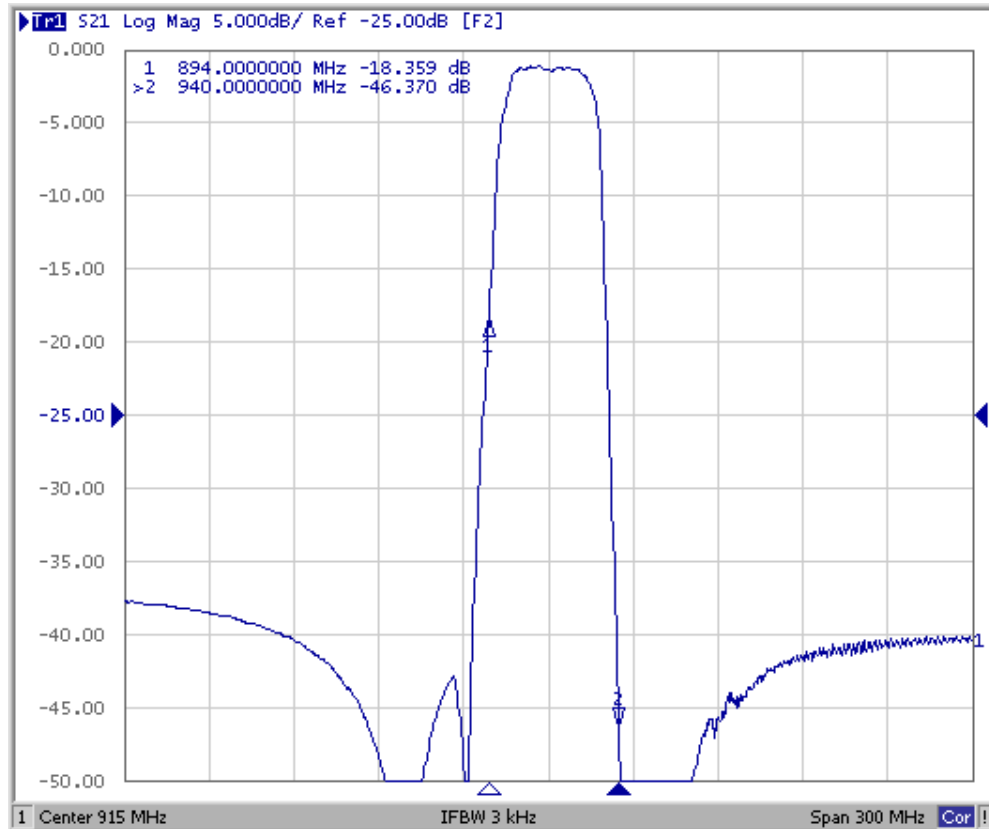

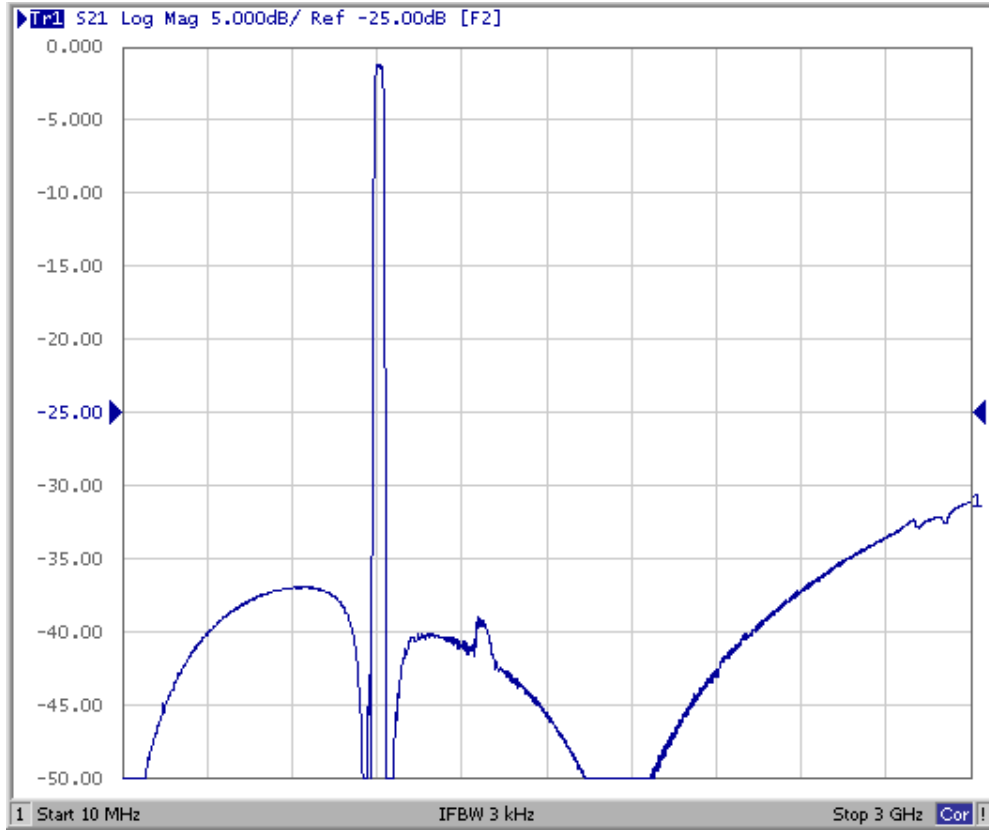

Filter SWR Plots

S11

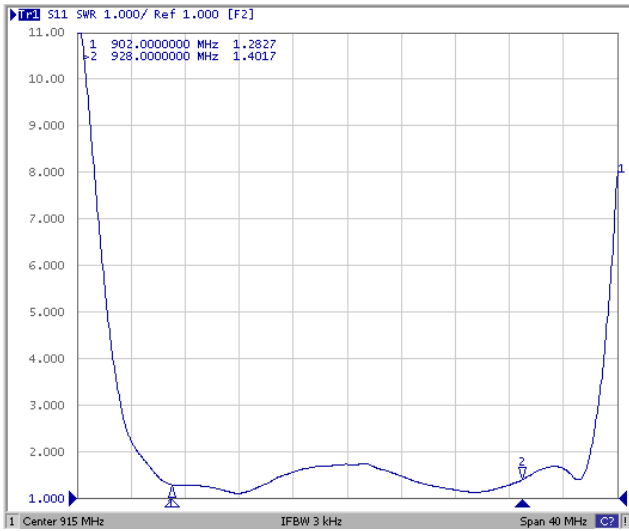

S22

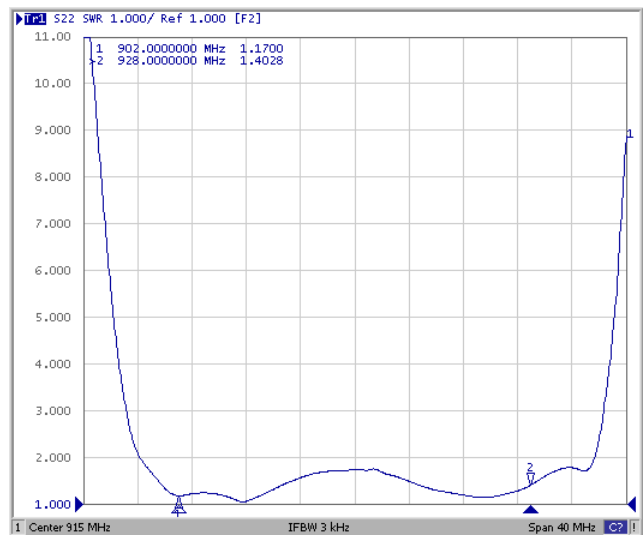

SM3030-6 Case

6-Terminal Ceramic Surface-Mount Case 3.0 X 3.0 mm Nominal Footprint

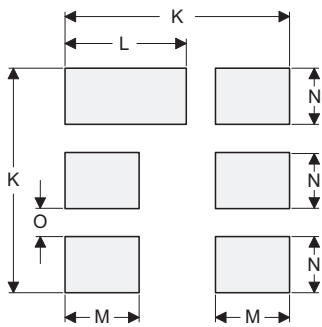
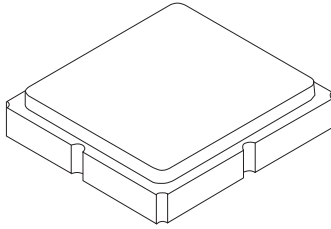

PCB Footprint Top View

Case and PCB Footprint Dimensions

Dimension	mm			Inches		
	Min	Nom	Max	Min	Nom	Max
A	2.87	3.00	3.13	0.113	0.118	0.123
B	2.87	3.00	3.13	0.113	0.118	0.123
C	1.12	1.25	1.38	0.044	0.049	0.054
D	0.77	0.90	1.03	0.030	0.035	0.040
E	2.67	2.80	2.93	0.105	0.110	0.115
F	1.47	1.60	1.73	0.058	0.063	0.068
G	0.72	0.85	0.98	0.028	0.033	0.038
H	1.37	1.50	1.63	0.054	0.059	0.064
I	0.47	0.60	0.73	0.019	0.024	0.029
J	1.17	1.30	1.43	0.046	0.051	0.056
K		3.20			0.126	
L		1.70			0.067	
M		1.05			0.041	
N		0.81			0.032	
O		0.38			0.015	

Case Materials

Materials	
Solder Pad Plating	0.3 to 1.0 μ m Gold over 1.27 to 8.89 μ m Nickel
Lid Plating	2.0 to 3.0 μ m Nickel
Body	Al ₂ O ₃ Ceramic
Pb Free	

Electrical Connections

Connection	Terminals
Input	2
Output	5
Case Ground	All others

TOP VIEW

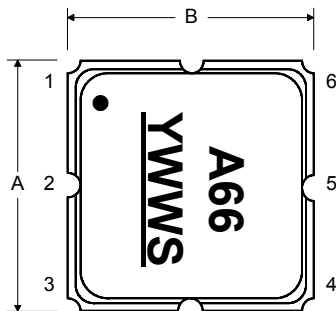

BOTTOM VIEW

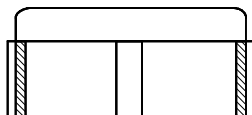
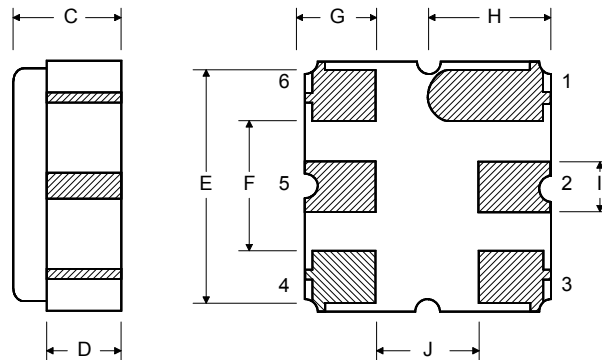

Tape and Reel Specifications

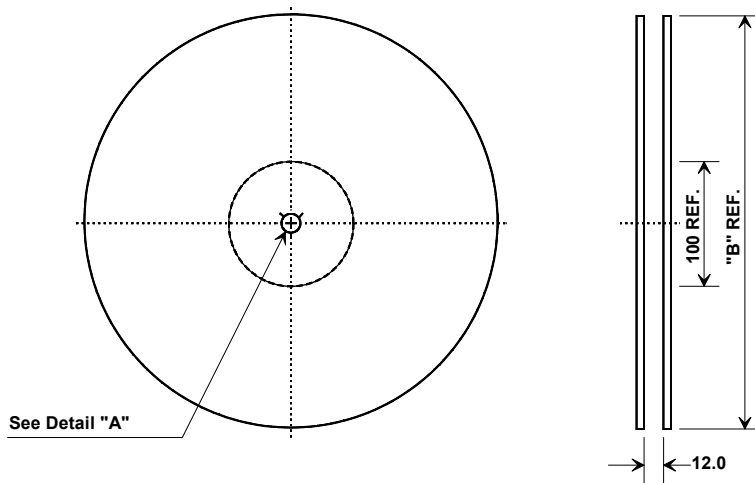

"B"		Quantity Per Reel
Inches	millimeters	
7	178	500
13	330	3000

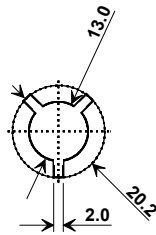

COMPONENT ORIENTATION and DIMENSIONS

Carrier Tape Dimensions	
Ao	3.35 mm
Bo	3.35 mm
Ko	1.40 mm
Pitch	8.0 mm
W	12.0 mm

