



Chipsmall Limited consists of a professional team with an average of over 10 year of expertise in the distribution of electronic components. Based in Hongkong, we have already established firm and mutual-benefit business relationships with customers from,Europe,America and south Asia,supplying obsolete and hard-to-find components to meet their specific needs.

With the principle of “Quality Parts,Customers Priority,Honest Operation,and Considerate Service”,our business mainly focus on the distribution of electronic components. Line cards we deal with include Microchip,ALPS,ROHM,Xilinx,Pulse,ON,Everlight and Freescale. Main products comprise IC,Modules,Potentiometer,IC Socket,Relay,Connector.Our parts cover such applications as commercial,industrial, and automotives areas.

We are looking forward to setting up business relationship with you and hope to provide you with the best service and solution. Let us make a better world for our industry!



Contact us

Tel: +86-755-8981 8866 Fax: +86-755-8427 6832

Email & Skype: info@chipsmall.com Web: www.chipsmall.com

Address: A1208, Overseas Decoration Building, #122 Zhenhua RD., Futian, Shenzhen, China



SF4-AH SERIES

- FIBER SENSORS
- LASER SENSORS
- PHOTOELECTRIC SENSORS
- MICRO PHOTOELECTRIC SENSORS
- AREA SENSORS
- SAFETY COMPONENTS
- PRESSURE SENSORS
- INDUCTIVE PROXIMITY SENSORS
- PARTICULAR USE SENSORS
- SENSOR OPTIONS
- WIRE-SAVING SYSTEMS
- MEASUREMENT SENSORS
- STATIC CONTROL DEVICES
- LASER MARKERS
- Selection Guide
- Light Curtains
- SF4B
- SF2B
- BSF4-AH80
- Control Units
- SF-C10
- Optical Touch Switch
- SW-101
- Other Products
- Definition of Sensing Heights

Related Information ■ General terms and conditions..... P.1 ■ SF-AC P.588
 ■ Glossary of terms..... P.983~ ■ General precautions P.986~

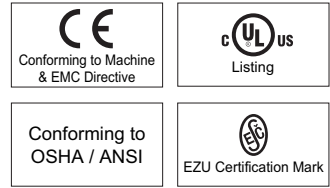

SUNX website <http://www.sunx.com>

Compact size of 21 × 28 mm 0.827 × 1.102 in Type 4 light curtain

ORDER GUIDE

Light curtains Mating cable is not supplied with the light curtain. Please order it separately.

Type	Appearance	Operating range (Note 1)	Model No. (Note 2)		Number of beam channels	Protective height (mm in) (Note 3)
			NPN output equivalent type	PNP output equivalent type		
Normal case		0.3 to 7 m 0.984 to 22.966 ft	SF4-AH8-N	SF4-AH8	8	190 7.480
			SF4-AH12-N	SF4-AH12	12	270 10.630
			SF4-AH16-N	SF4-AH16	16	350 13.780
			SF4-AH20-N	SF4-AH20	20	430 16.929
			SF4-AH24-N	SF4-AH24	24	510 20.079
			SF4-AH28-N	SF4-AH28	28	590 23.228
			SF4-AH32-N	SF4-AH32	32	670 26.378
			SF4-AH36-N	SF4-AH36	36	750 29.528
			SF4-AH40-N	SF4-AH40	40	830 32.677
			SF4-AH48-N	SF4-AH48	48	990 38.976
			SF4-AH56-N	SF4-AH56	56	1,150 45.276
			SF4-AH64-N	SF4-AH64	64	1,310 51.575
			SF4-AH72-N	SF4-AH72	72	1,470 57.874
			SF4-AH80-N	SF4-AH80	80	1,630 64.173
			SF4-AH88-N	SF4-AH88	88	1,790 70.472
			SF4-AH96-N	SF4-AH96	96	1,950 76.772
With spatter protection hood		0.3 to 7 m 0.984 to 22.966 ft	—	SF4-AH8-H	8	190 7.480
			—	SF4-AH12-H	12	270 10.630
			—	SF4-AH16-H	16	350 13.780
			—	SF4-AH20-H	20	430 16.929
			—	SF4-AH24-H	24	510 20.079
			—	SF4-AH28-H	28	590 23.228
			—	SF4-AH32-H	32	670 26.378
			—	SF4-AH36-H	36	750 29.528
			—	SF4-AH40-H	40	830 32.677
			—	SF4-AH48-H	48	990 38.976
			—	SF4-AH56-H	56	1,150 45.276
			—	SF4-AH64-H	64	1,310 51.575
—	SF4-AH72-H	72	1,470 57.874			
—	SF4-AH80-H	80	1,630 64.173			
—	SF4-AH88-H	88	1,790 70.472			
—	SF4-AH96-H	96	1,950 76.772			

- Notes: 1) The operating range is the possible setting distance between the emitter and the receiver.
 The light curtain can detect an object less than 0.3 m 0.984 ft away.
 2) The model No. with suffix "P" shown on the label affixed to the product is the emitter, "D" shown on the label is the receiver.
 (e.g.) Emitter of SF4-AH8-N: SF4-AH8P-N
 Receiver of SF4-AH8-N: SF4-AH8D-N
 3) Refer to the "Definition of light curtain and area sensor sensing heights" (p.589) for the definition of the protective height.

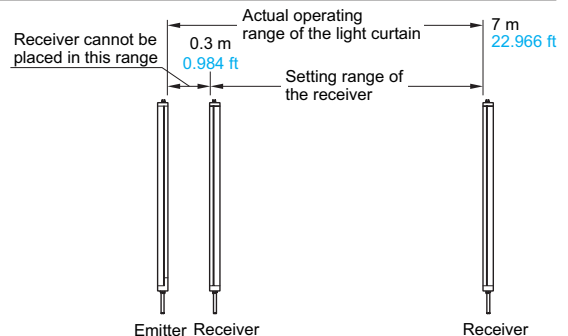



ORDER GUIDE
P.569~

SPECIFICATIONS
P.573

PRECAUTIONS FOR PROPER USE
P.573

ORDER GUIDE

Mating cables Mating cable is not supplied with the light curtain. Please order it separately.

Designation	Appearance	Model No.	Description
Cable with connector on one end		SF4A-CC3	Length: 3 m 9.843 ft Net weight: 380 g approx. (two cables) These cables are used for wiring. 6-core shielded cable, with connector on one end, two cables per set
		SF4A-CC7	Length: 7 m 22.966 ft Net weight: 800 g approx. (two cables) Cable outer diameter: $\phi 6$ mm $\phi 0.236$ in Connector outer diameter: $\phi 14$ mm $\phi 0.551$ in max. Cable color: Gray (for emitter) Gray with black line (for receiver)
		SF4A-CC10	Length: 10 m 32.808 ft Net weight: 1,120 g approx. (two cables) Connector color: Gray (for emitter) Black (for receiver) The min. bending radius: R30 mm 1.181 in
Cable with connector on both ends		SF4A-CCJ10	Length: 10 m 32.808 ft Net weight: 1,160 g approx. (two cables) This cable is used for cable extension. Shielded cable, with connector on both ends, two cables per set Cable outer diameter: $\phi 6$ mm $\phi 0.236$ in Connector outer diameter: $\phi 14$ mm $\phi 0.551$ in max. Cable color: Gray (for emitter) Gray with black line (for receiver) Connector color: Gray (for emitter), Black (for receiver) The min. bending radius: R30 mm 1.181 in
Cable for series connection (Note)		SF4A-CSL02	Length: 200 mm 7.874 in Net weight: 70 g approx. (two cables)
		SF4A-CSL05	Length: 500 mm 19.685 in Net weight: 100 g approx. (two cables)
		SF4A-CSL10	Length: 1 m 3.281 ft Net weight: 160 g approx. (two cables)
		SF4A-CSL30	Length: 3 m 9.843 ft Net weight: 380 g approx. (two cables) Used to connect light curtains in series Shielded cable, with connector on both ends, two cables per set (common for emitter and receiver) Cable outer diameter: $\phi 6$ mm $\phi 0.236$ in Cable color: Gray (common for emitter and receiver) The min. bending radius: R30 mm 1.181 in

Note: Note that the dimensions of the SF4-AH series will change when using the cable for series connection (SF4A-CSL□). Contact our office for further details.

Handy-controller

Designation	Appearance	Model No.
Handy-controller		SF-HC

FIBER SENSORS

LASER SENSORS

PHOTO-ELECTRIC SENSORS

MICRO PHOTO-ELECTRIC SENSORS

AREA SENSORS

SAFETY COMPONENTS

PRESSURE SENSORS

INDUCTIVE PROXIMITY SENSORS

PARTICULAR USE SENSORS

SENSOR OPTIONS

WIRE-SAVING SYSTEMS

MEASUREMENT SENSORS

STATIC CONTROL DEVICES

LASER MARKERS

Selection Guide

Light Curtains

SF4B

SF2B

BSF4-AH80

Control Units

SF-C10

Optical Touch Switch

SW-101

Other Products

Definition of Sensing Heights

ORDER GUIDE

Spare parts (Accessories for light curtain)

Designation	Model No.	Description	
Rear mounting bracket	MS-SF2N-1	Used to mount the light curtain on the rear surface (1 set for emitter and receiver)	
U-shaped rear mounting intermediate supporting bracket (Note)	MS-SF2N-2	For SF4-AH□(-N)	Used to hold the light curtain at the intermediate position for protection against vibration (for rear surface mounting) (1 set for emitter and receiver)
	MS-SF4A-H2	For SF4-AH□-H	
L-shaped intermediate supporting bracket (Note)	MS-SF2N-L	Used to install the U-shaped intermediate supporting bracket on the wall side, etc. (1 set for emitter and receiver)	

Note: The number of sets required varies depending on the product. Refer to "SPECIFICATIONS" on p.573 for further details.

Rear mounting bracket

- **MS-SF2N-1**

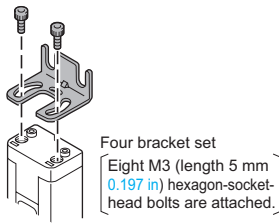

U-shaped rear mounting intermediate supporting bracket
L-shaped intermediate supporting bracket

- **MS-SF2N-2**
- **MS-SF4A-H2**
- **MS-SF2N-L**

Note: The right figure is only applicable to the **MS-SF2N-2**. The **MS-SF4A-H2** has a different shape.

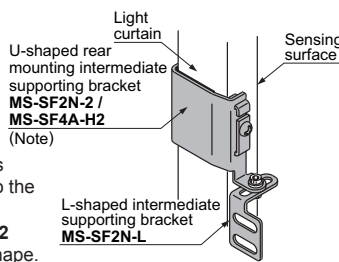

- **MS-SF2N-2 / MS-SF4A-H2**
Set of 2 pcs. each of U-shaped rear supporting bracket and retaining plate

- **MS-SF2N-L**
Two L-shaped bracket set
Two M3 (length 10 mm 0.394 in) pan head screws, two M4 (length 10 mm 0.394 in) hexagon-socket-head bolts and two nuts are attached.

OPTIONS

Designation	Model No.	Description	
Large display unit for light curtain	SF-IND-2	With the large display unit put on the light curtain, the operation is easily observable from various directions. • Supply voltage: 24 V DC ± 15 % • Current consumption: 12 mA or less	
Side mounting bracket	MS-SF2N-3	Used for side-mounting of light curtains (four bracket set for emitter and receiver)	
U-shaped side mounting intermediate supporting bracket (Note 1)	MS-SF2N-4	For SF4-AH□(-N)	Used to hold the light curtain at the intermediate position for protection against vibration (for side mounting) (1 set for emitter and receiver)
	MS-SF4A-H4	For SF4-AH□-H	
Center sensor mounting bracket (Note 2)	MS-SF2N-5	Used for one-point rear mounting Convenient for mounting on an aluminum frame (four bracket set for emitter and receiver)	
Laser alignment tool (Note 3)	SF-LAT-2N	Easy to align the beam axis with the visible laser beam	

- Notes: 1) The number of sets required varies depending on the product. Contact our office for further details.
2) Multiple beam channel sensors requiring the intermediate supporting bracket (36 beam channels or more) cannot be mounted on an aluminum frame with the center sensor mounting bracket.
3) Refer to "SF4B series" on p.494 / p.513 for further details about the laser alignment tool.

U-shaped side mounting intermediate supporting bracket

- **MS-SF2N-4**
- **MS-SF4A-H4**

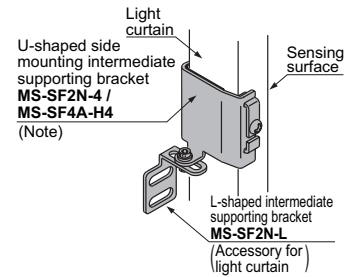

Note: The above figure is only applicable to the **MS-SF2N-4**. The **MS-SF4A-H4** has a different shape.

- **MS-SF2N-4 / MS-SF4A-H4**
Set of 2 pcs. each of U-shaped side supporting bracket and retaining plate

Large display unit for light curtain

- **SF-IND-2**

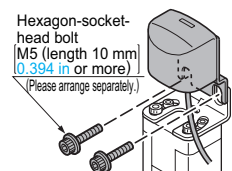

Attaches to upper edge of light curtain. Tighten together the mounting bracket provided with the light curtain and the mounting bracket of **SF-IND-2**.

Side mounting bracket

- **MS-SF2N-3**

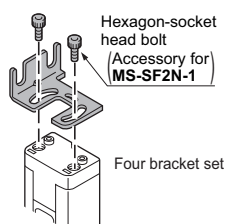

Center sensor mounting bracket

- **MS-SF2N-5**

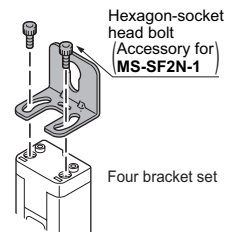

Laser alignment tool

- **SF-LAT-2N**

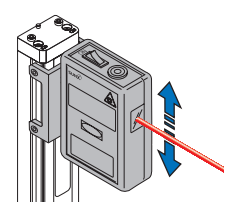

OPTIONS

Applicable beam channels		8 beam channels	12 beam channels	16 beam channels	20 beam channels	24 beam channels	28 beam channels	32 beam channels	36 beam channels	40 beam channels	48 beam channels	56 beam channels	64 beam channels	72 beam channels	80 beam channels	88 beam channels	96 beam channels
Front protection cover	For SF4-AH□(-N)	Model No. FC-SF4A-H8	FC-SF4A-H12	FC-SF4A-H16	FC-SF4A-H20	FC-SF4A-H24	FC-SF4A-H28	FC-SF4A-H32	FC-SF4A-H36	FC-SF4A-H40	FC-SF4A-H48	FC-SF4A-H56	FC-SF4A-H64	FC-SF4A-H72	FC-SF4A-H80	FC-SF4A-H88	FC-SF4A-H96
	For SF4-AH□-H	Model No. FC-SF4A-H8-H	FC-SF4A-H12-H	FC-SF4A-H16-H	FC-SF4A-H20-H	FC-SF4A-H24-H	FC-SF4A-H28-H	FC-SF4A-H32-H	FC-SF4A-H36-H	FC-SF4A-H40-H	FC-SF4A-H48-H	FC-SF4A-H56-H	FC-SF4A-H64-H	FC-SF4A-H72-H	FC-SF4A-H80-H	FC-SF4A-H88-H	FC-SF4A-H96-H
Slit mask	For SF4-AH□(-N)	Model No. OS-SF4A-H8	OS-SF4A-H12	OS-SF4A-H16	OS-SF4A-H20	OS-SF4A-H24	OS-SF4A-H28	OS-SF4A-H32	OS-SF4A-H36	OS-SF4A-H40	OS-SF4A-H48	OS-SF4A-H56	OS-SF4A-H64	OS-SF4A-H72	OS-SF4A-H80	OS-SF4A-H88	OS-SF4A-H96
	For SF4-AH□-H	Model No. OS-SF4A-H8-H	OS-SF4A-H12-H	OS-SF4A-H16-H	OS-SF4A-H20-H	OS-SF4A-H24-H	OS-SF4A-H28-H	OS-SF4A-H32-H	OS-SF4A-H36-H	OS-SF4A-H40-H	OS-SF4A-H48-H	OS-SF4A-H56-H	OS-SF4A-H64-H	OS-SF4A-H72-H	OS-SF4A-H80-H	OS-SF4A-H88-H	OS-SF4A-H96-H
Front protection unit	Model No.	MC-SF4AH-8	MC-SF4AH-12	MC-SF4AH-16	MC-SF4AH-20	MC-SF4AH-24	MC-SF4AH-28	MC-SF4AH-32	MC-SF4AH-36	MC-SF4AH-40	MC-SF4AH-48	MC-SF4AH-56	MC-SF4AH-64	MC-SF4AH-72	MC-SF4AH-80	MC-SF4AH-88	MC-SF4AH-96

Note: The model Nos. given above denote a single unit, not a pair of units. 2 pcs. (2 sets) are required to mount the emitter / receiver.

Front protection cover

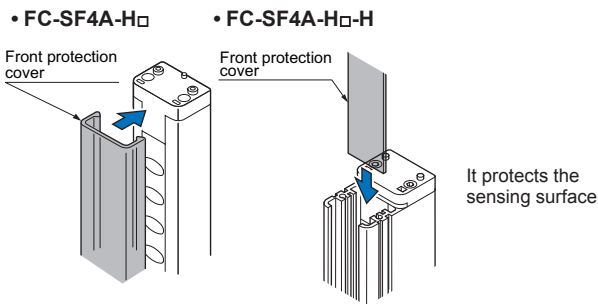

Front protection unit

• MC-SF4AH-□
It protects sensing surface from damage due to striking of an object.

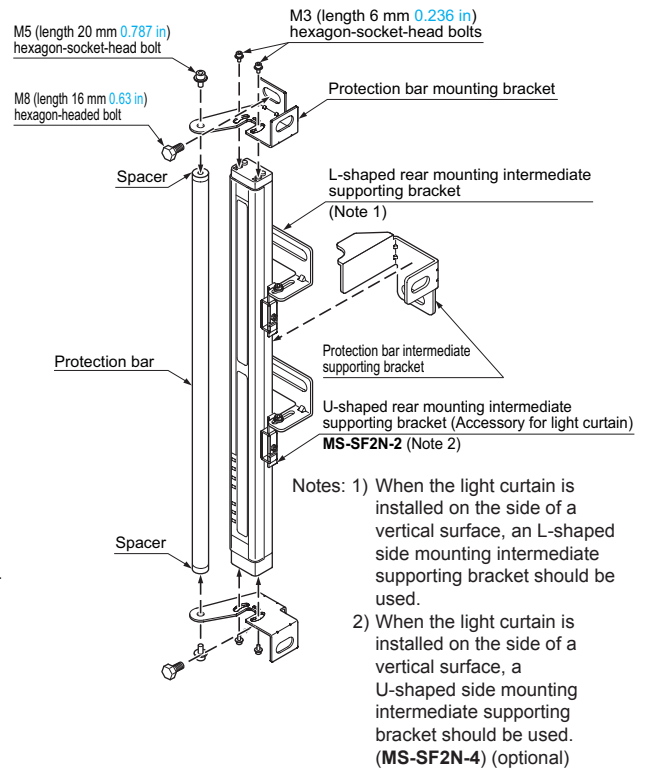

Operating range

<FC-SF4A-H□ / FC-SF4A-H□-H>

- Front protection cover on the emitter side: 0.3 to 7 m **0.984 to 22.966 ft**
- Front protection cover on the receiver side: 0.3 to 6 m **0.984 to 19.685 ft**
- Front protection cover on both sides: 0.3 to 5 m **0.984 to 16.404 ft**

Slit mask

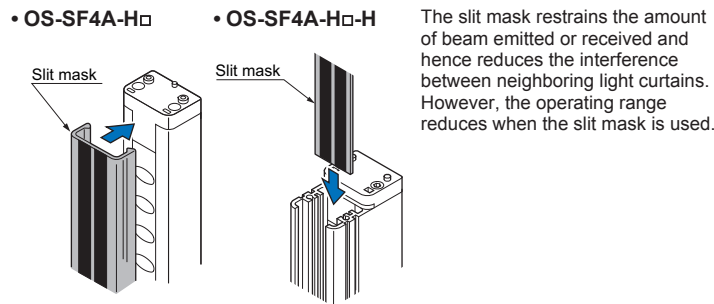

Operating range

<OS-SF4A-H□>

- Slit on the emitter side: 0.3 to 4 m **0.984 to 13.123 ft**
- Slit on the receiver side: 0.3 to 3 m **0.984 to 9.843 ft**
- Slit on both sides: 0.3 to 2 m **0.984 to 6.561 ft**

<OS-SF4A-H□-H>

- Slit on the emitter side: 0.3 to 3 m **0.984 to 9.843 ft**
- Slit on the receiver side: 0.3 to 3 m **0.984 to 9.843 ft**
- Slit on both sides: 0.3 to 1.5 m **0.984 to 4.921 ft**

FIBER SENSORS

LASER SENSORS

PHOTO-ELECTRIC SENSORS

MICRO PHOTO-ELECTRIC SENSORS

AREA SENSORS

SAFETY COMPONENTS

PRESSURE SENSORS

INDUCTIVE PROXIMITY SENSORS

PARTICULAR USE SENSORS

SENSOR OPTIONS

WIRE-SAVING SYSTEMS

MEASUREMENT SENSORS

STATIC CONTROL DEVICES

LASER MARKERS

Selection Guide

Light Curtains

SF4B

SF2B

BSF4-AH80

Control Units

SF-C10

Optical Touch Switch

SW-101

Other Products

Definition of Sensing Heights

SPECIFICATIONSThe CAD data in the dimensions can be downloaded from the SUNX website: <http://www.sunx.com>**Common specifications**

Item	Type	NPN output equivalent	PNP output equivalent
	Model No.	SF4-AH□-N	SF4-AH□(-H)
Applicable standards	EN 954-1 (Category 4), EN 61496-1 (Type 4), IEC 61496-1/2 (Type 4), UL 61496-1/2 (Type 4), UL 1998		
Operating range	0.3 to 7 m 0.984 to 22.966 ft		
Detection capability	ø30 mm ø1.181 in opaque object (Note 2)		
Effective aperture angle	±2.5° or less [for an operating range exceeding 3 m 9.843 ft (conforming to IEC 61496-2 / UL 61496-2)]		
Supply voltage	24 V DC ± 10 % Ripple P-P 10 % or less		
Control outputs (OSSD1, OSSD2)	Semiconductor output (NPN output equivalent) 2 outputs • Maximum sink current: 200 mA • Applied voltage: Same as supply voltage (between control output and 0 V) • Residual voltage: 2 V or less (at 200 mA sink current)		Semiconductor output (PNP output equivalent) 2 outputs • Maximum source current: 200 mA • Applied voltage: Same as supply voltage (between control output and +V) • Residual voltage: 2.5 V or less (at 200 mA source current)
	Operation mode	ON when all beam channels are received, OFF when one or more beam channels are interrupted (OFF also in case of any malfunction in the light curtain or the synchronization signal)	
Response time	In normal operation: OFF response 11 ms or less, ON response 70 ms or less In the blanking function set condition: OFF response 15 ms or less, ON response 70 ms or less		
	Series connection	In normal operation: OFF response 20 ms or less, ON response 70 ms or less In the blanking function set condition: OFF response 20 ms or less, ON response 70 ms or less	
Auxiliary output (Non-safety output)	NPN open-collector transistor • Maximum sink current: 60 mA • Applied voltage: Same as supply voltage (between auxiliary output and 0 V) • Residual voltage: 2 V or less (at 60 mA sink current)		PNP open-collector transistor • Maximum source current: 60 mA • Applied voltage: Same as supply voltage (between auxiliary output and +V) • Residual voltage: 2.5 V or less (at 60 mA source current)
	Operation mode	OFF when control outputs are ON, ON when control outputs are OFF (It is possible to use the handy-controller to switch the mode to ON when control outputs are ON and OFF when control outputs are OFF.)	
Interference prevention function	Incorporated (In case of series connection: 3 sets max., Max. beam channels 192 beam channels)		
Test input (emission halt) function	Incorporated		
Test input (emission halt input)	Emission: 0 to +1.5 V (source current: 2 mA or less) Emission halt: Open, or +9 V to Vs (Note 3)	Emission: +9 V to Vs (sink current: 2 mA or less)(Note 3) Emission halt: Open, or 0 to +1.5 V	
Degree of protection	IP65 (IEC), (Refer to p.984 for details of standards)		
Ambient temperature	-10 to +55 °C +14 to +131 °F (No dew condensation or icing allowed), Storage: -25 to +70 °C -13 to +158 °F		
Emitting element	Infrared LED (Peak emission wavelength: 870 nm 0.034 mil)		
Material	Enclosure: Aluminium, Front case: Polycarbonate, Lens: Polycarbonate, Cap: Polycarbonate and ABS		
Dimensions	W28 × H (protective height + 27) × D21 mm W1.102 × H (protective height + 1.063) × D0.827 in	W28 × H (protective height + 27) × D21 mm (SF4-AH□-H: D41 mm) W1.102 × H (protective height + 1.063) × D0.827 in (SF4-AH□-H: D1.614 in)	
Accessories	MS-SF2N-1 (Rear sensor mounting bracket): 1 set for emitter and receiver MS-SF2N-2 (U-shaped rear mounting intermediate supporting bracket, MS-SF4A-H2 for "-H" type): (Note 4) MS-SF2N-L (L-shaped intermediate supporting bracket): (Note 4), SF4-AH-TR (Test rod): 1 pc.		

- Notes: 1) Where measurement conditions have not been specified precisely, the conditions used were an ambient temperature of +20 °C +68 °F.
2) In this light curtain, the floating blanking function can be set by using the Handy-controller (**SF-HC**)(optional). When the floating blanking function is used, the size of the min. sensing object is changed. For details on the floating blanking function, refer to **SF4B** series on p.484 / p.506.
3) Vs is the same value as the voltage of the used power supply to be used.
4) **MS-SF2N-2 / MS-SF4A-H2** (U-shaped rear mounting intermediate supporting bracket) and **MS-SF2N-L** (L-shaped intermediate supporting bracket) are attached with the following light curtains.
The number of attached U-shaped rear mounting intermediate supporting bracket and L-shaped intermediate supporting bracket are different depending on the light curtain as follows.
SF4-AH36(-N/H), SF4-AH40(-N/H): 1 set, **SF4-AH48(-N/H)**: 2 sets, **SF4-AH56(-N/H), SF4-AH64(-N/H), SF4-AH72(-N/H)**: 3 sets
SF4-AH80(-N/H): 4 sets, **SF4-AH88(-N/H), SF4-AH96(-N/H)**: 5 sets

PRECAUTIONS FOR PROPER USE

Refer to p.986~ for general precautions.



- Do not utilize this light curtain in "PSDI Mode", in which the light curtain is utilized as an activator for machinery.
- To use this product in the U.S.A., refer to OSHA 1910. 212 and OSHA 1910. 217 for installation, and in Europe, refer to EN 999 as well. Observe your national and local requirements before installing this product.

- This catalog is a guide to select a suitable product. Be sure to read the instruction manual attached to the product prior to its use.