



Chipsmall Limited consists of a professional team with an average of over 10 year of expertise in the distribution of electronic components. Based in Hongkong, we have already established firm and mutual-benefit business relationships with customers from,Europe,America and south Asia,supplying obsolete and hard-to-find components to meet their specific needs.

With the principle of “Quality Parts,Customers Priority,Honest Operation,and Considerate Service”,our business mainly focus on the distribution of electronic components. Line cards we deal with include Microchip,ALPS,ROHM,Xilinx,Pulse,ON,Everlight and Freescale. Main products comprise IC,Modules,Potentiometer,IC Socket,Relay,Connector.Our parts cover such applications as commercial,industrial, and automotives areas.

We are looking forward to setting up business relationship with you and hope to provide you with the best service and solution. Let us make a better world for our industry!



Contact us

Tel: +86-755-8981 8866 Fax: +86-755-8427 6832

Email & Skype: info@chipsmall.com Web: www.chipsmall.com

Address: A1208, Overseas Decoration Building, #122 Zhenhua RD., Futian, Shenzhen, China



8A, 50V - 600V Glass Passivated Super Fast Rectifiers

FEATURES

- High efficiency, low VF
- High current capability
- High surge current capability
- Low power loss
- Compliant to RoHS Directive 2011/65/EU and in accordance to WEEE 2002/96/EC
- Halogen-free according to IEC 61249-2-21

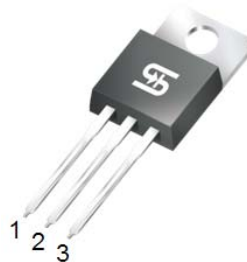
TO-220AB

MECHANICAL DATA

Case: TO-220AB

Molding compound, UL flammability classification rating 94V-0

Part no. with suffix "H" means AEC-Q101 qualified

Packing code with suffix "G" means green compound (halogen-free)

Terminal: Matte tin plated leads, solderable per JESD22-B102

Meet JESD 201 class 2 whisker test

Polarity: As marked

Mounting torque: 0.56 Nm max.

Weight: 1.82 g (approximately)



MAXIMUM RATINGS AND ELECTRICAL CHARACTERISTICS (T_A=25°C unless otherwise noted)

PARAMETER	SYMBOL	SF	SF	SF	SF	SF	SF	SF	SF	UNIT
		801G	802G	803G	804G	805G	806G	807G	808G	
Maximum repetitive peak reverse voltage	V _{RRM}	50	100	150	200	300	400	500	600	V
Maximum RMS voltage	V _{RMS}	35	70	105	140	210	280	350	480	V
Maximum DC blocking voltage	V _{DC}	50	100	150	200	300	400	500	600	V
Maximum average forward rectified current	I _{F(AV)}	8								A
Peak forward surge current, 8.3 ms single half sine-wave superimposed on rated load	I _{FSM}	125								A
Maximum instantaneous forward voltage (Note 1) @ 4 A	V _F	0.975			1.3		1.7			V
Maximum reverse current @ rated V _R T _J =25°C T _J =100°C	I _R	10 400								μA
Maximum reverse recovery time (Note 2)	t _{rr}	35								ns
Typical junction capacitance (Note 3)	C _J	70				50				pF
Typical thermal resistance	R _{θJC}	3								°C/W
Operating junction temperature range	T _J	- 55 to +150								°C
Storage temperature range	T _{STG}	- 55 to +150								°C

Note 1: Pulse test with PW=300μs, 1% duty cycle

Note 2: Test conditions: I_F=0.5A, I_R=1.0A, I_{RR}=0.25A.

Note 3: Measured at 1 MHz and applied reverse voltage of 4.0 V DC.

ORDERING INFORMATION					
PART NO.	PART NO. SUFFIX	PACKING CODE	PACKING CODE SUFFIX (*)	PACKAGE	PACKING
SF80xG (Note 1)	H	C0	G	TO-220AB	50 / Tube

Note 1: "x" defines voltage from 50V (SF801G) to 600V (SF808G)

*: Optional available

EXAMPLE					
EXAMPLE PART NO.	PART NO.	PART NO. SUFFIX	PACKING CODE	PACKING CODE SUFFIX	DESCRIPTION
SF808GHC0G	SF808G	H	C0	G	AEC-Q101 qualified Green compound

RATINGS AND CHARACTERISTICS CURVES

(T_A=25°C unless otherwise noted)

FIG.1 MAXIMUM FORWARD CURRENT DERATING CURVE

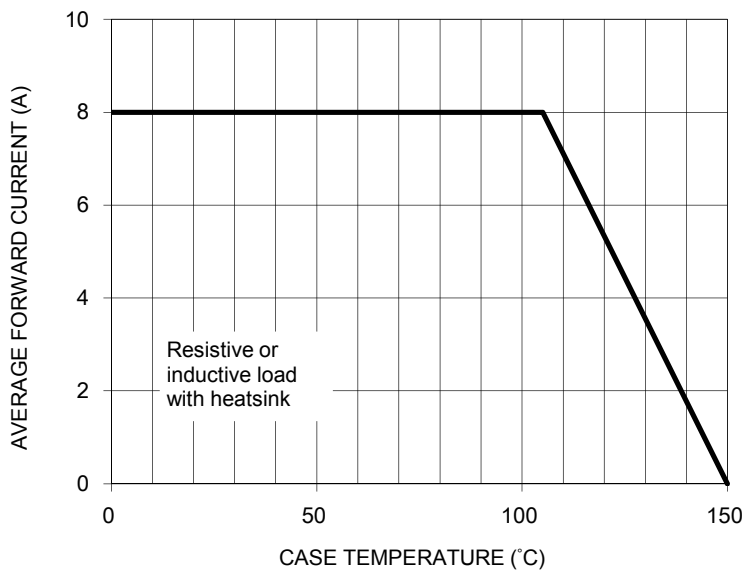

FIG. 2 TYPICAL REVERSE CHARACTERISTICS

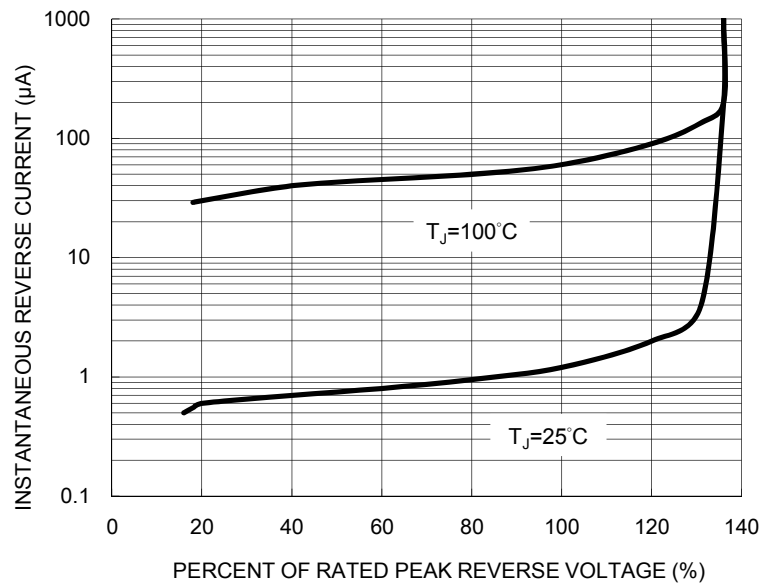

FIG. 3 MAXIMUM NON-REPETITIVE FORWARD SURGE CURRENT

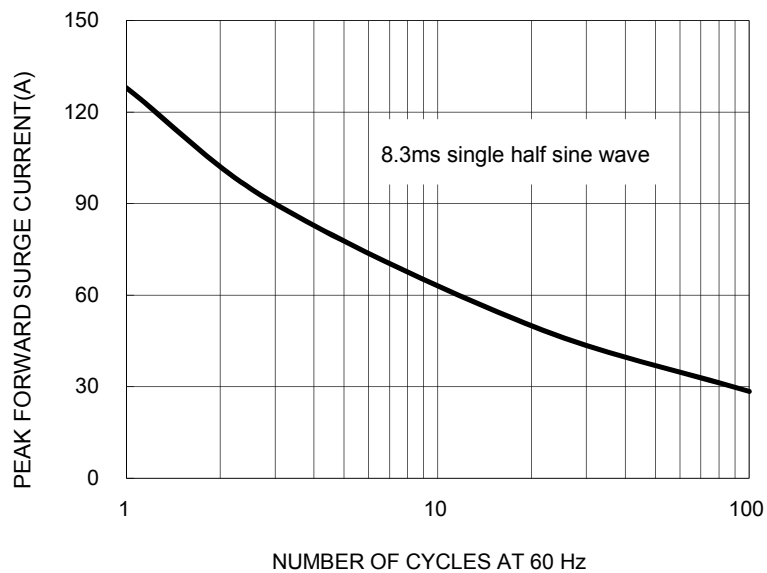

FIG. 4 TYPICAL FORWARD CHARACTERISTICS

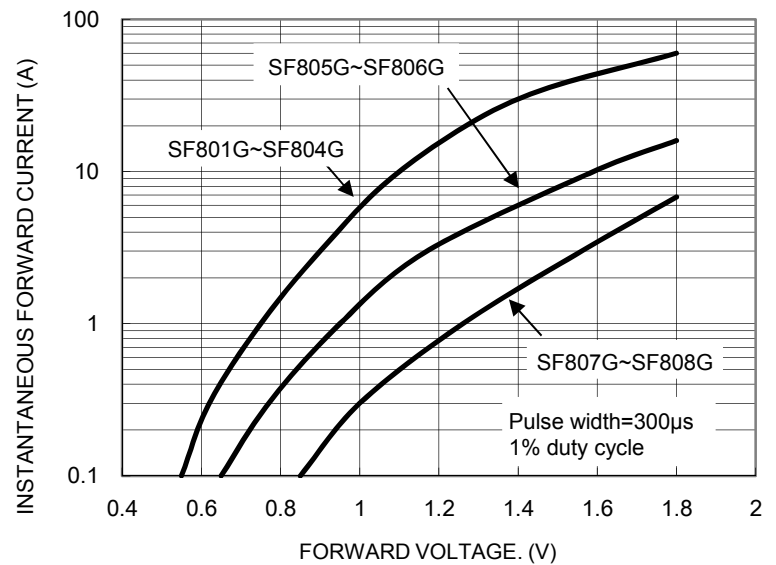

FIG. 5 TYPICAL JUNCTION CAPACITANCE

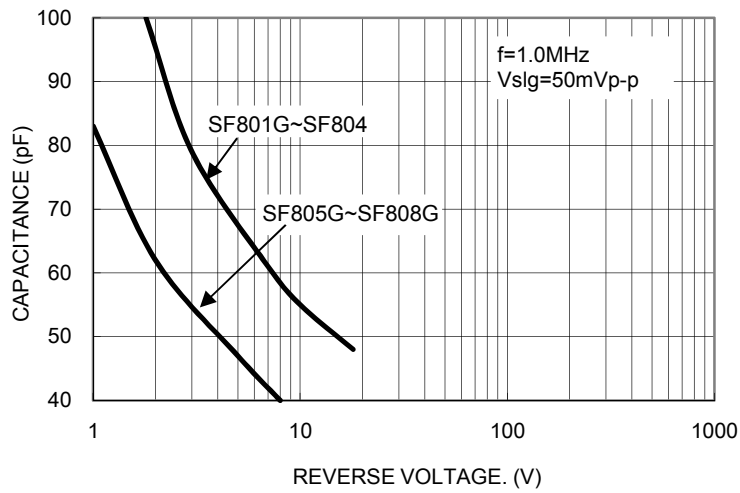
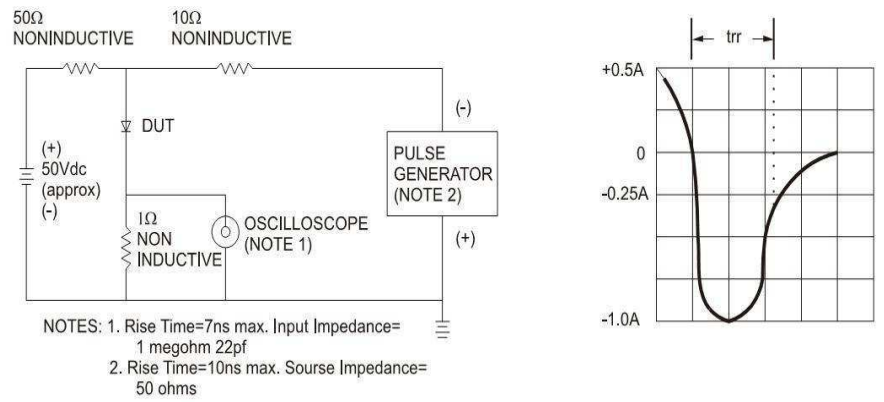
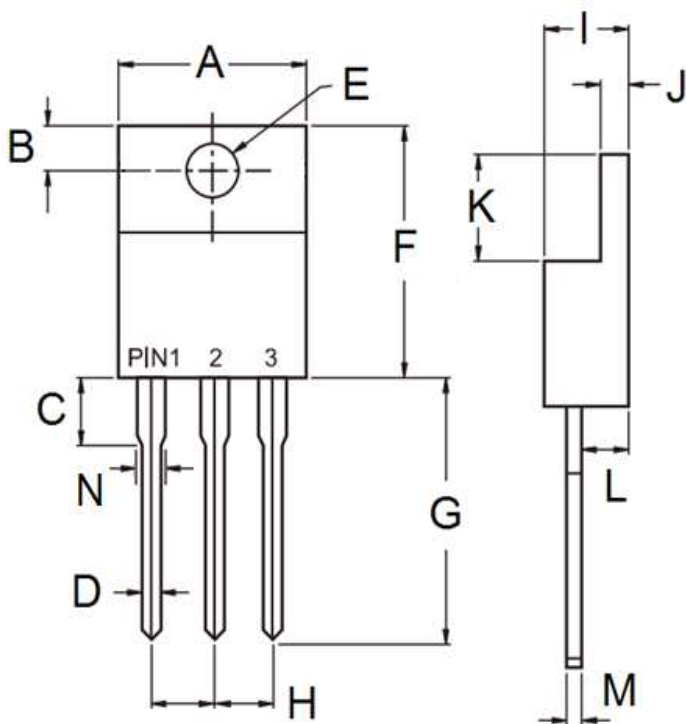

FIG.6 REVERSE RECOVERY TIME CHARACTERISTIC AND TEST CIRCUIT DIAGRAM



PACKAGE OUTLINE DIMENSIONS
TO-220AB



DIM.	Unit (mm)		Unit (inch)	
	Min	Max	Min	Max
A	-	10.50	-	0.413
B	2.62	3.44	0.103	0.135
C	2.80	4.20	0.110	0.165
D	0.68	0.94	0.027	0.037
E	3.54	4.00	0.139	0.157
F	14.60	16.00	0.575	0.630
G	13.19	14.79	0.519	0.582
H	2.41	2.67	0.095	0.105
I	4.42	4.76	0.174	0.187
J	1.14	1.40	0.045	0.055
K	5.84	6.86	0.230	0.270
L	2.20	2.80	0.087	0.110
M	0.35	0.64	0.014	0.025
N	1.14	1.77	0.045	0.070

MARKING DIAGRAM

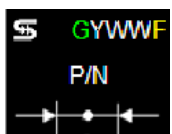

- P/N = Specific Device Code
- G = Green Compound
- YWW = Date Code
- F = Factory Code

Notice

Specifications of the products displayed herein are subject to change without notice. TSC or anyone on its behalf, assumes no responsibility or liability for any errors or inaccuracies.

Information contained herein is intended to provide a product description only. No license, express or implied, to any intellectual property rights is granted by this document. Except as provided in TSC's terms and conditions of sale for such products, TSC assumes no liability whatsoever, and disclaims any express or implied warranty, relating to sale and/or use of TSC products including liability or warranties relating to fitness for a particular purpose, merchantability, or infringement of any patent, copyright, or other intellectual property right.

The products shown herein are not designed for use in medical, life-saving, or life-sustaining applications. Customers using or selling these products for use in such applications do so at their own risk and agree to fully indemnify TSC for any damages resulting from such improper use or sale.