



Chipsmall Limited consists of a professional team with an average of over 10 year of expertise in the distribution of electronic components. Based in Hongkong, we have already established firm and mutual-benefit business relationships with customers from,Europe,America and south Asia,supplying obsolete and hard-to-find components to meet their specific needs.

With the principle of "Quality Parts,Customers Priority,Honest Operation,and Considerate Service",our business mainly focus on the distribution of electronic components. Line cards we deal with include Microchip,ALPS,ROHM,Xilinx,Pulse,ON,Everlight and Freescale. Main products comprise IC,Modules,Potentiometer,IC Socket,Relay,Connector.Our parts cover such applications as commercial,industrial, and automotives areas.

We are looking forward to setting up business relationship with you and hope to provide you with the best service and solution. Let us make a better world for our industry!



Contact us

Tel: +86-755-8981 8866 Fax: +86-755-8427 6832

Email & Skype: info@chipsmall.com Web: www.chipsmall.com

Address: A1208, Overseas Decoration Building, #122 Zhenhua RD., Futian, Shenzhen, China



NOTES:

1. $\text{\textcircled{C}}$ REPRESENTS A CRITICAL DIMENSION.
2. MINIMUM PUSHOUT FORCE: .5 LB.
3. COPLANARITY: .004[0.10] = POS 05 THRU 26
.006[0.15] = POS 27 THRU 50
4. TUBE ALL POSITIONS. PARTS TO BE TUBED WITH NOTCH GOING WITH ARROW.
5. PINS CAN BE ORIENTED IN ANY DIRECTION; BOTH ROWS MUST FACE SAME WAY.
6. SEE NOTCH FOR PROPER ORIENTATION.
7. MAXIMUM PIN HEIGHT VARIATION: .003[0.08].
8. DUE TO HIGH AMOUNT OF INSERTION FORCE NEEDED, THE -LC OPTION IS NOT COMPATIBLE WITH AUTO PLACEMENT. SAMTEC RECOMMENDS MANUAL PLACEMENT FOR ALL ASSEMBLIES WITH THE -LC OPTION.
9. MEASUREMENT TO BE TAKEN AT BEND.

SFC-1XX-XX-XX-D-XX

No OF POSITIONS
ALL POSITIONS AVAILABLE
-02 THRU -50

OPTIONS
(LEAVE BLANK FOR STANDARD AND USE SFM-XX-D)
-A: ALIGNMENT PIN (USE SFM-XX-D-A) (SEE FIG 4, SHT 2)
-LC: LOCKING CLIP (SEE FIG 6, SHT 3 & NOTE 8) (USE SFM-XX-D-LC)
-TR: TAPE & REEL (SEE SHT 3)
-K: POLYIMIDE FILM PAD (.005[0.13] THICKNESS) (SEE FIG 3, SHT 2) (USE K-DOT-.157-.250-.005)

LEAD STYLE
-T1: THROUGH HOLE (SEE FIG. 1, SHT. 1)
-T2: SURFACE MOUNT (SEE FIG. 2, SHT. 2)

BODY SPECIFICATION
-D: DOUBLE ROW

PLATING SPECIFICATION
-F: 3 μ " FLASH SELECTIVE GOLD IN CONTACT AREA, MATTE TIN ON TAIL
-L: 10 μ " LIGHT SELECTIVE GOLD IN CONTACT AREA, MATTE TIN ON TAIL
-FM: 3 μ " FLASH SELECTIVE GOLD IN CONTACT AREA, MATTE TIN ON TAIL
-LM: 10 μ " LIGHT SELECTIVE GOLD IN CONTACT AREA, MATTE TIN ON TAIL

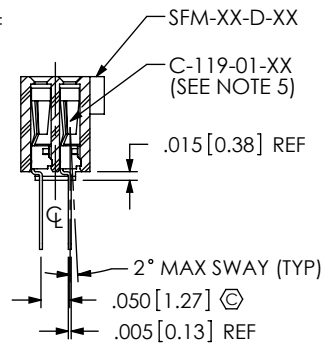
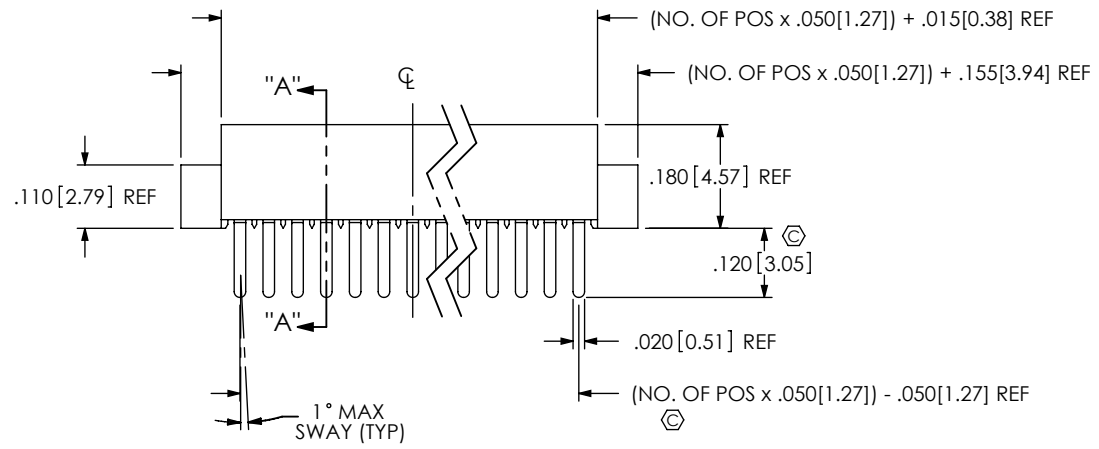
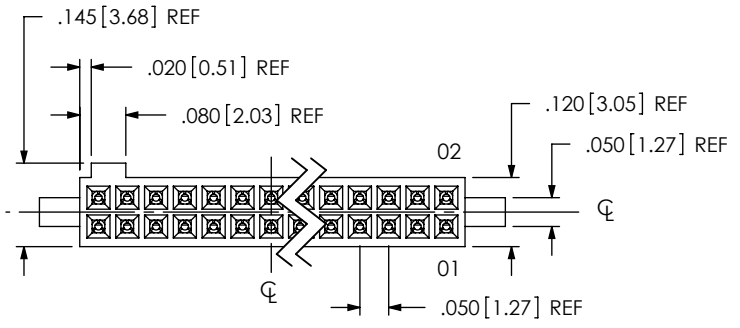

SECTION "A"- "A"

FIG 1
THROUGH HOLE/STRAIGHT MODIFIED

UNLESS OTHERWISE SPECIFIED, DIMENSIONS ARE IN INCHES.
TOLERANCES ARE:
DECIMALS ANGLES
.XX: $\pm .01$ [.3] 2°
.XXX: $\pm .005$ [.13]
.XXXX: $\pm .0020$ [.051]

PROPRIETARY NOTE
* THIS DOCUMENT CONTAINS CONFIDENTIAL AND PROPRIETARY INFORMATION AND ALL DESIGN, MANUFACTURING, REPRODUCTION, USE, PATENT RIGHTS AND SALES RIGHTS ARE EXPRESSLY RESERVED BY SAMTEC, INC. THIS DOCUMENT SHALL NOT BE DISCLOSED, IN WHOLE OR PART, TO ANY UNAUTHORIZED PERSON OR ENTITY NOR REPRODUCED, TRANSFERRED OR INCORPORATED IN ANY OTHER PROJECT IN ANY MANNER WITHOUT THE EXPRESS WRITTEN CONSENT OF SAMTEC, INC.

samtec
520 PARK EAST BLVD., NEW ALBANY, IN 47150
PHONE: 812-944-6733 FAX: 812-948-5047
e-Mail: info@SAMTEC.com code 55322

MATERIAL: DO NOT SCALE DRAWING SHEET SCALE: 3:1
INSULATOR: LCP, COLOR: BLACK
CONTACT: PHOSPHOR BRONZE

DESCRIPTION:
.050 x .050 SOCKET STRIP DOUBLE ROW ASSEMBLY
DWG. NO.
SFC-1XX-XX-XX-D-XX

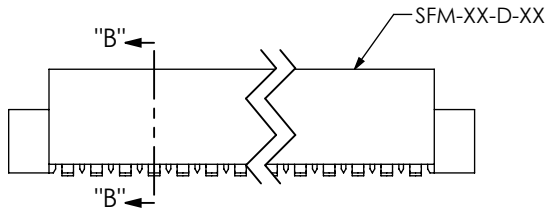
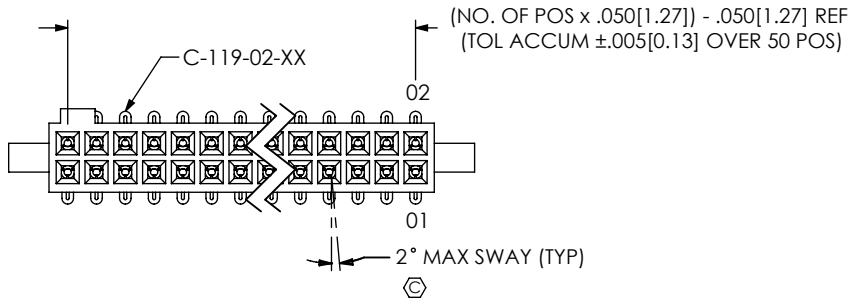
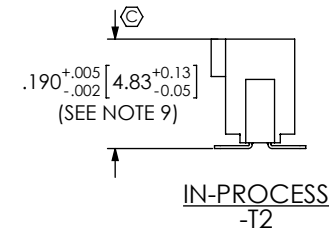
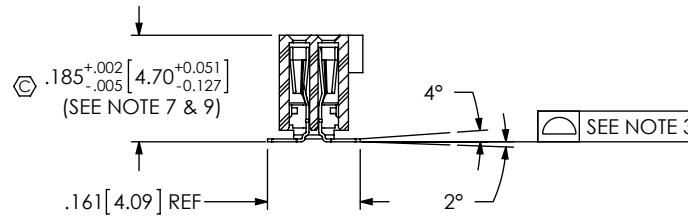

FIG 2
-T2: SURFACE MOUNT
(SAME AS FIG 1, DIFFERENT AS SHOWN)



FOR HAND FILL ONLY
NOTE: DIMENSION APPLIES PRIOR TO RE-PRESS, SEE SECTION "B-B" FOR FINISHED DIMENSION

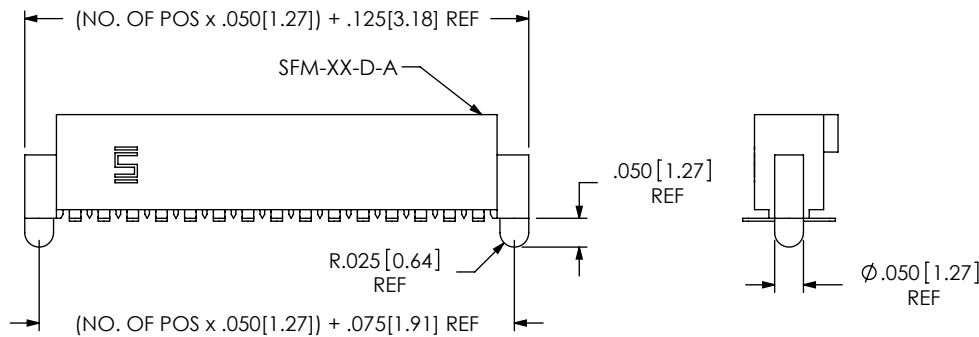

FIG 4
-A: ALIGNMENT PIN
(SAME AS FIG 2, DIFFERENT AS SHOWN)

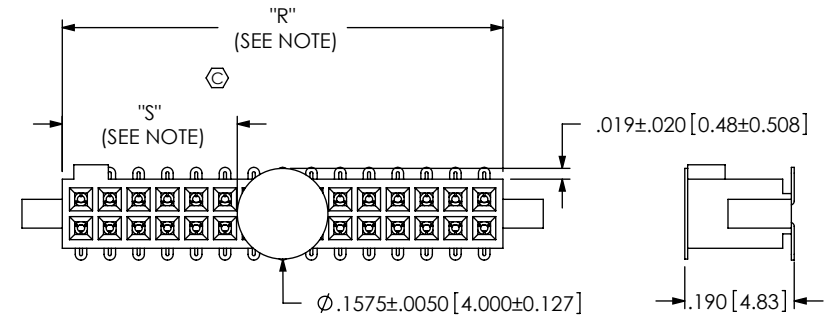

FIG 3
-K: POLYIMIDE FILM PAD
(SAME AS FIG 2, DIFFERENT AS SHOWN)
NOTE: "R" = USED MEASURED DIMENSION REF
"S" = {"R" - .1575[4.000]}/2±.020[0.51]

PROPRIETARY NOTE
THIS DOCUMENT CONTAINS CONFIDENTIAL AND PROPRIETARY INFORMATION AND ALL DESIGN, MANUFACTURING, REPRODUCTION, USE, PATENT RIGHTS AND SALES RIGHTS ARE EXPRESSLY RESERVED BY SAMTEC, INC. THIS DOCUMENT SHALL NOT BE DISCLOSED, IN WHOLE OR PART, TO ANY UNAUTHORIZED PERSON OR ENTITY NOR REPRODUCED, TRANSFERRED OR INCORPORATED IN ANY OTHER PROJECT IN ANY MANNER WITHOUT THE EXPRESS WRITTEN CONSENT OF SAMTEC, INC.



520 PARK EAST BLVD, NEW ALBANY, IN 47150
PHONE: 812-944-6733 FAX: 812-948-5047
e-Mail info@SAMTEC.com code 55322

DO NOT SCALE DRAWING

SHEET SCALE: 3:1

DESCRIPTION:
.050 x .050 SOCKET STRIP DOUBLE ROW ASSEMBLY

DWG. NO.
SFC-1XX-XX-XX-D-XX

BY: BRATCHER 5/25/01 SHEET 2 OF 3

REVISION X

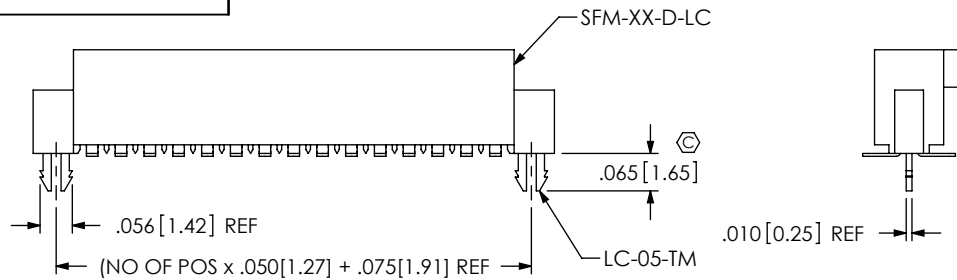
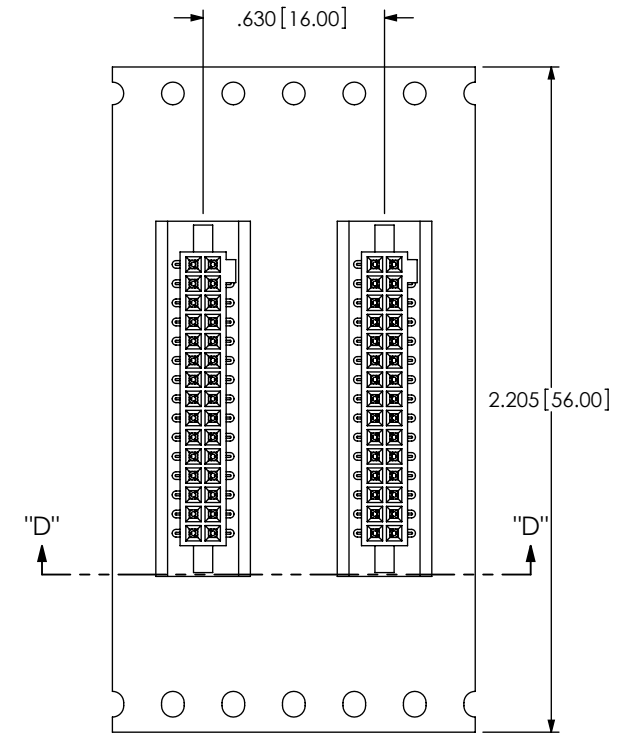
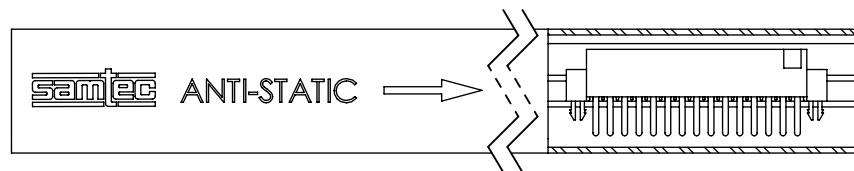
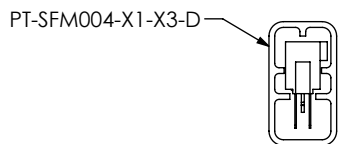
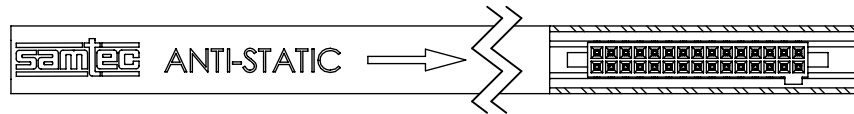
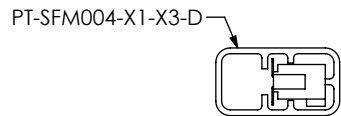
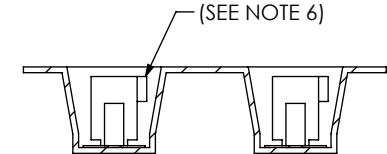

FIG 6
-LC: LOCKING CLIP
(SAME AS FIG 2, DIFFERENT AS SHOWN)



UNWINDING DIRECTION →



SECTION "D"- "D"
SCALE 2 : 1
PACKAGING VIEW
-TR: TAPE AND REEL

LEAD STYLE	PACKAGING TUBE	PLUG
-105-T2-X-D, -105-T2-X-D-LC, -105-T2-D-A, -105-T2-D-K-LC	PT-1-24-14-09	TP-24-02
-T1-D, -T1-D-LC, -T1-D-A, -T1-D-K	PT-SFM004-X1-X3-D	TP-24-02
-T2-D, -T2-D-K, -T2-D-LC, -T2-D-A, -T2-D-K-A, -T2-D-LC-K	PT-SFM004-X1-X3-D	TP-24-02
-102-T1-D, -102-T1-D-LC, -102-T1-D-A, -102-T1-D-K	PT-1-24-15-09	TP-24-02

5 POS -T1 LEAD STYLE MAY BE TUBED USING
PT-1-24-15-09, TP-24-02

F:\DWG\MISC\MKTG\SFC-1XX-XX-XX-D-XX-MKT.SLDDRW

PROPRIETARY NOTE

THIS DOCUMENT CONTAINS CONFIDENTIAL AND PROPRIETARY INFORMATION AND ALL DESIGN, MANUFACTURING, REPRODUCTION, USE, PATENT RIGHTS AND SALES RIGHTS ARE EXPRESSLY RESERVED BY SAMTEC, INC. THIS DOCUMENT SHALL NOT BE DISCLOSED, IN WHOLE OR PART, TO ANY UNAUTHORIZED PERSON OR ENTITY NOR REPRODUCED, TRANSFERRED OR INCORPORATED IN ANY OTHER PROJECT IN ANY MANNER WITHOUT THE EXPRESS WRITTEN CONSENT OF SAMTEC, INC.



520 PARK EAST BLVD, NEW ALBANY, IN 47150
PHONE: 812-944-6733 FAX: 812-948-5047
e-Mail info@SAMTEC.com code 55322

DO NOT SCALE DRAWING

SHEET SCALE: 3:1

DESCRIPTION:
.050 x .050 SOCKET STRIP DOUBLE ROW ASSEMBLY

DWG. NO.
SFC-1XX-XX-XX-D-XX

BY: BRATCHER 5/25/01

SHEET 3 OF 3