



Chipsmall Limited consists of a professional team with an average of over 10 year of expertise in the distribution of electronic components. Based in Hongkong, we have already established firm and mutual-benefit business relationships with customers from,Europe,America and south Asia,supplying obsolete and hard-to-find components to meet their specific needs.

With the principle of “Quality Parts,Customers Priority,Honest Operation,and Considerate Service”,our business mainly focus on the distribution of electronic components. Line cards we deal with include Microchip,ALPS,ROHM,Xilinx,Pulse,ON,Everlight and Freescale. Main products comprise IC,Modules,Potentiometer,IC Socket,Relay,Connector.Our parts cover such applications as commercial,industrial, and automotives areas.

We are looking forward to setting up business relationship with you and hope to provide you with the best service and solution. Let us make a better world for our industry!



Contact us

Tel: +86-755-8981 8866 Fax: +86-755-8427 6832

Email & Skype: info@chipsmall.com Web: www.chipsmall.com

Address: A1208, Overseas Decoration Building, #122 Zhenhua RD., Futian, Shenzhen, China



High Speed PIN Photodiode

Version 1.2

SFH 2701

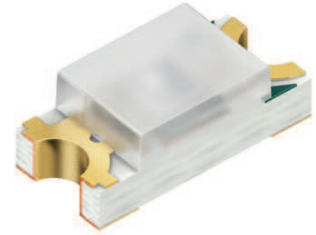

Features:

- Especially suitable for applications from 400 nm to 1050 nm
- Fast switching time within the specified wavelength
- Fast switching time at low reverse voltage (<5V)
- Ultra short decay time ("slow tail")
- IEC Standard 3216 Chipled package

Applications

- Optical disc drives (CD, DVD)
- Photointerrupters
- Industrial electronics
- For control and drive circuits

Ordering Information

Type:	Photocurrent I_P [μA] $\lambda = 650 \text{ nm}, E_e = 0.5 \text{ mW/cm}^2, V_R = 5 \text{ V}$	Ordering Code
SFH 2701	1.2 (≥ 0.8)	Q65110A2960

Maximum Ratings ($T_A = 25\text{ °C}$)

Parameter	Symbol	Values	Unit
Operating and storage temperature range	$T_{op}; T_{stg}$	-40 ... 85	°C
Reverse voltage	V_R	15	V
Reverse voltage ($t < 120\text{ s}$)	V_R	20	V
ESD withstand voltage (acc. to ANSI/ ESDA/ JEDEC JS-001 - HBM)	V_{ESD}	2000	V

Characteristics ($T_A = 25\text{ °C}$)

Parameter	Symbol	Values	Unit
Spectral sensitivity ($\lambda = 650\text{ nm}$)	(typ) $S_{\lambda\text{ typ}}$	0.45	A / W
Spectral sensitivity ($\lambda = 780\text{ nm}$)	(typ) $S_{\lambda\text{ typ}}$	0.5	A / W
Photocurrent ($\lambda = 650\text{ nm}$, $E_e = 0.5\text{ mW/cm}^2$, $V_R = 5\text{ V}$)	(typ (min)) I_P	1.2 (≥ 0.8)	μA
Photocurrent ($\lambda = 780\text{ nm}$, $E_e = 0.5\text{ mW/cm}^2$, $V_R = 5\text{ V}$)	(typ) I_P	1.4	μA
Wavelength of max. sensitivity	(typ) $\lambda_{S\text{ max}}$	820	nm
Spectral range of sensitivity	(typ) $\lambda_{10\%}$	(typ) 400 ... 1050	nm
Radiant sensitive area	(typ) A	0.36	mm^2
Dimensions of radiant sensitive area	(typ) L x W	0.6 x 0.6	mm x mm
Distance from chip front to case surface	(typ) H	0.3	mm
Half angle	(typ) φ	± 60	°
Dark current ($V_R = 5\text{ V}$)	(typ (max)) I_R	0.05 (≤ 5)	nA
Rise and fall time ($V_R = 5\text{ V}$, $R_L = 50\ \Omega$, $\lambda = 650\text{ nm}$, $I_P = 1\text{ mA}$)	(typ) t_r, t_f	1.8	ns
Rise and fall time ($V_R = 5\text{ V}$, $R_L = 50\ \Omega$, $\lambda = 780\text{ nm}$, $I_P = 1\text{ mA}$)	(typ) t_r, t_f	2	ns
Forward voltage	(typ) V_F	0.8	V
Capacitance ($V_R = 0\text{ V}$, $f = 1\text{ MHz}$, $E = 0$)	(typ) C_0	3 (≤ 5)	pF

Parameter		Symbol	Values	Unit
Temperature coefficient of $S_{\lambda_{650nm}}$	(typ)	TC_1	-0.03	% / K
Temperature coefficient of $S_{\lambda_{780nm}}$	(typ)	TC_1	-0.01	% / K
Noise equivalent power ($NEP = 17.9 \times 10^{-15} \times (I_R)^{1/2} / S_\lambda$) ($V_R = 5 \text{ V}$, $\lambda = 650 \text{ nm}$)	(typ)	NEP	0.009	pW / Hz ^{1/2}

Relative Spectral Sensitivity ^{1) page 12}

$$S_{rel} = f(\lambda)$$

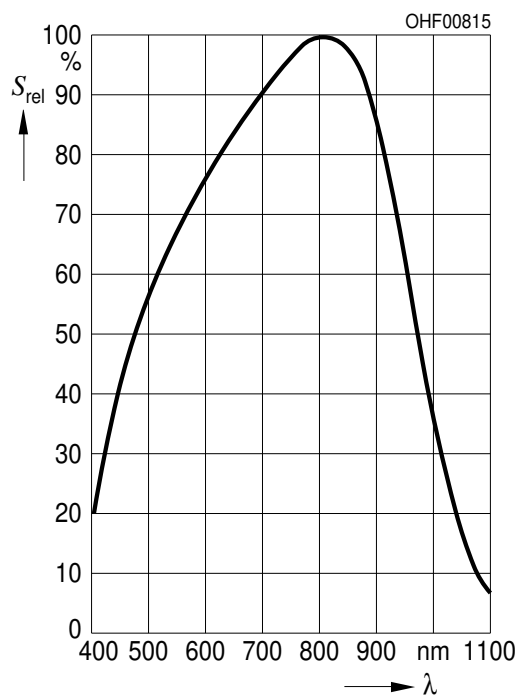

Dark Current ^{1) page 12}

$$I_R = f(V_R), E = 0$$

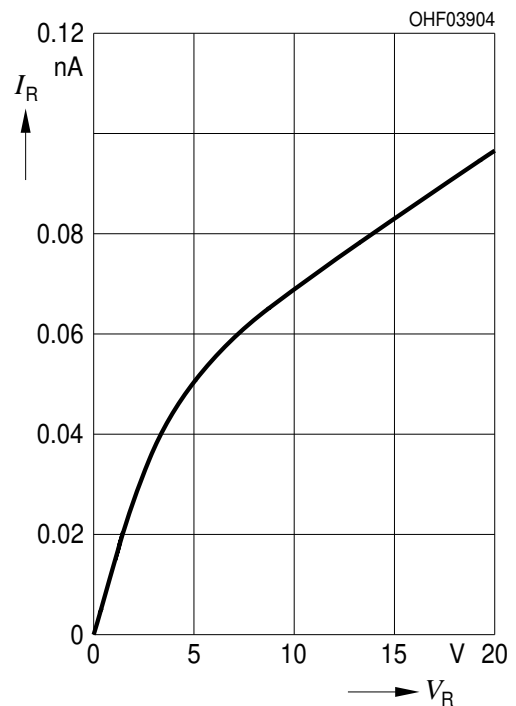

Capacitance ^{1) page 12}

$C = f(V_R), f = 1 \text{ MHz}, E = 0$

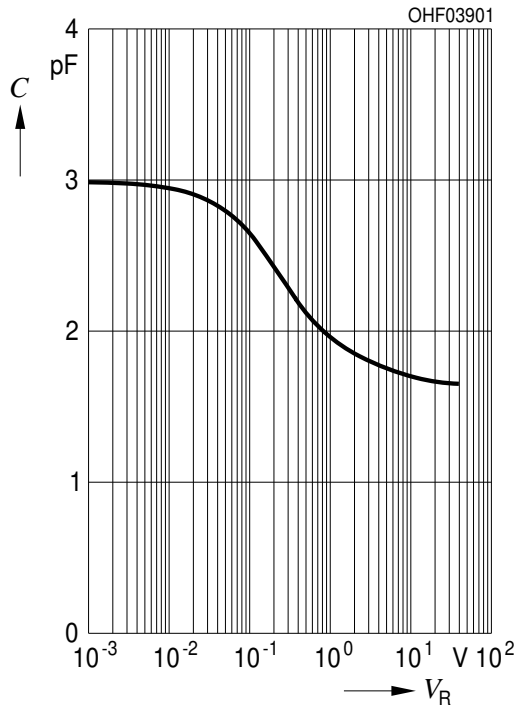

Switching Time ^{1) page 12}

$t_r, t_f = f(V_R), R_L = 50 \Omega, \lambda = 650 \text{ nm}, I_p = 200 \mu\text{A}$

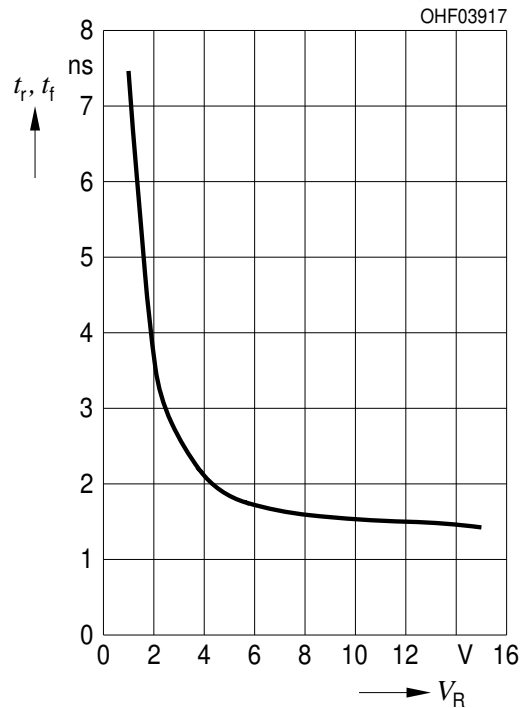

Dark Current ^{1) page 12}

$I_R = f(T_A), V_R = 5V, E = 0$

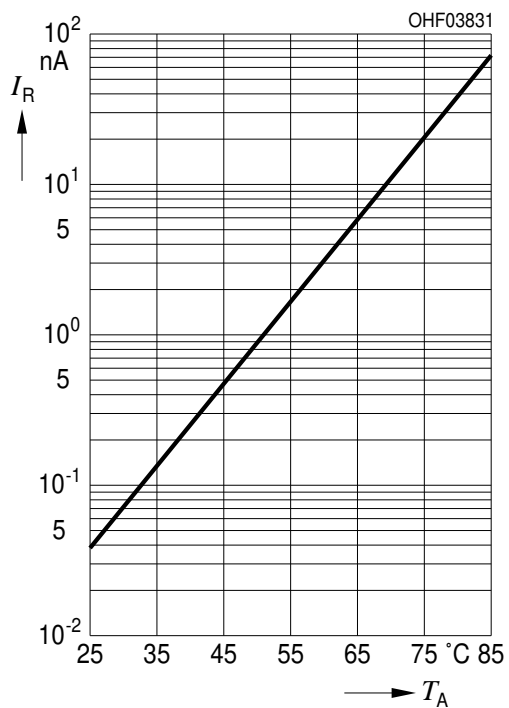

Directional Characteristics ^{1) page 12}

$S_{rel} = f(\phi)$

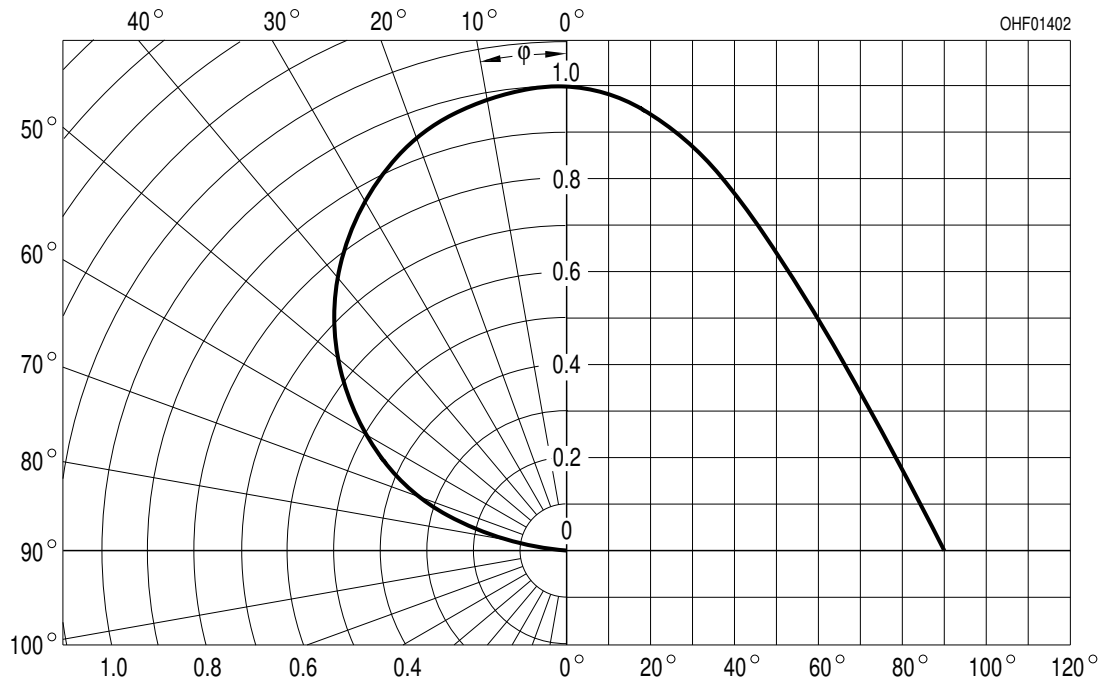

Package Outline

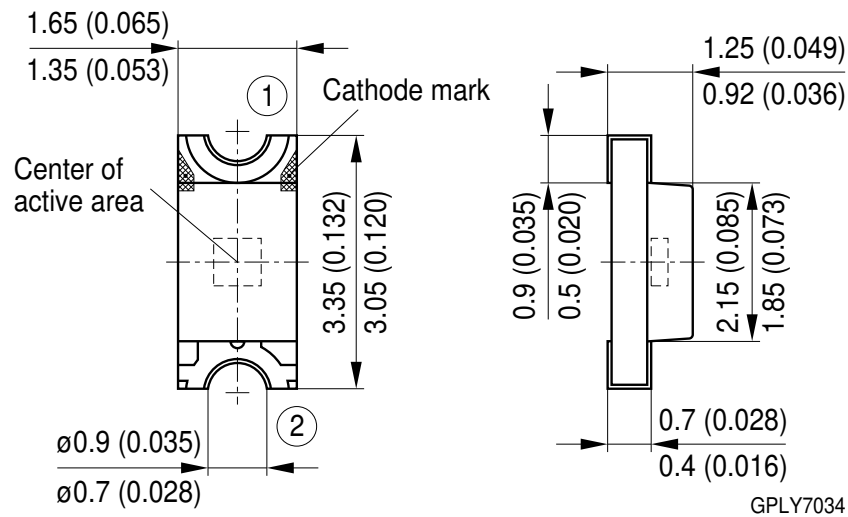

Dimensions in mm (inch).

Pinning

Pin	Description
1	Cathode
2	Anode

Package

Chiplid (EIA 1206)

Approximate Weight:

7.6 mg

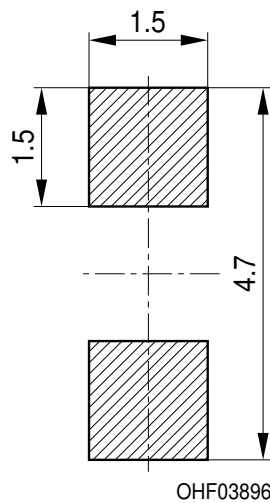
Recommended Solder Pad

Dimensions in mm.

Reflow Soldering Profile

Product complies to MSL Level 3 acc. to JEDEC J-STD-020E

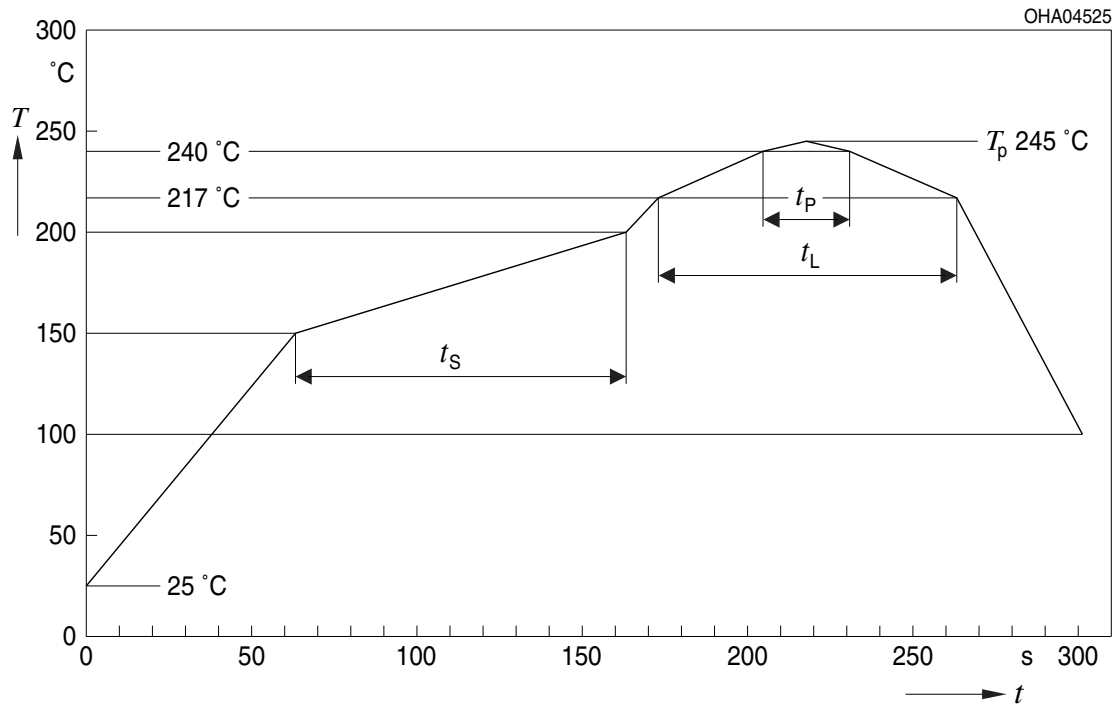

OHA04612

Profile Feature Profil-Charakteristik	Symbol Symbol	Pb-Free (SnAgCu) Assembly			Unit Einheit
		Minimum	Recommendation	Maximum	
Ramp-up rate to preheat*) 25 °C to 150 °C			2	3	K/s
Time t_S T_{Smin} to T_{Smax}	t_S	60	100	120	s
Ramp-up rate to peak*) T_{Smax} to T_P			2	3	K/s
Liquidus temperature	T_L	217			°C
Time above liquidus temperature	t_L		80	100	s
Peak temperature	T_P		245	260	°C
Time within 5 °C of the specified peak temperature $T_P - 5$ K	t_P	10	20	30	s
Ramp-down rate* T_P to 100 °C			3	6	K/s
Time 25 °C to T_P				480	s

All temperatures refer to the center of the package, measured on the top of the component

* slope calculation DT/Dt : Dt max. 5 s; fulfillment for the whole T-range

Taping

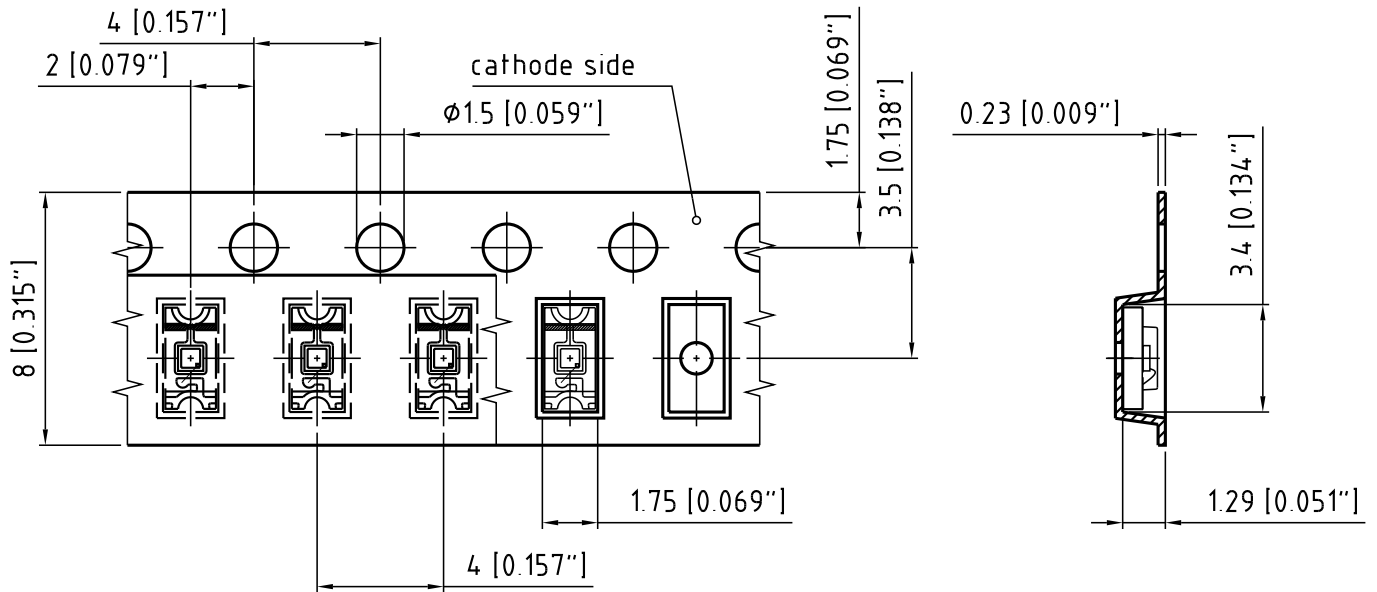

C63062-A3843-B2-02

Dimensions in mm (inch).

Tape and Reel

8 mm tape with 3000 pcs. on ϕ 180 mm reel

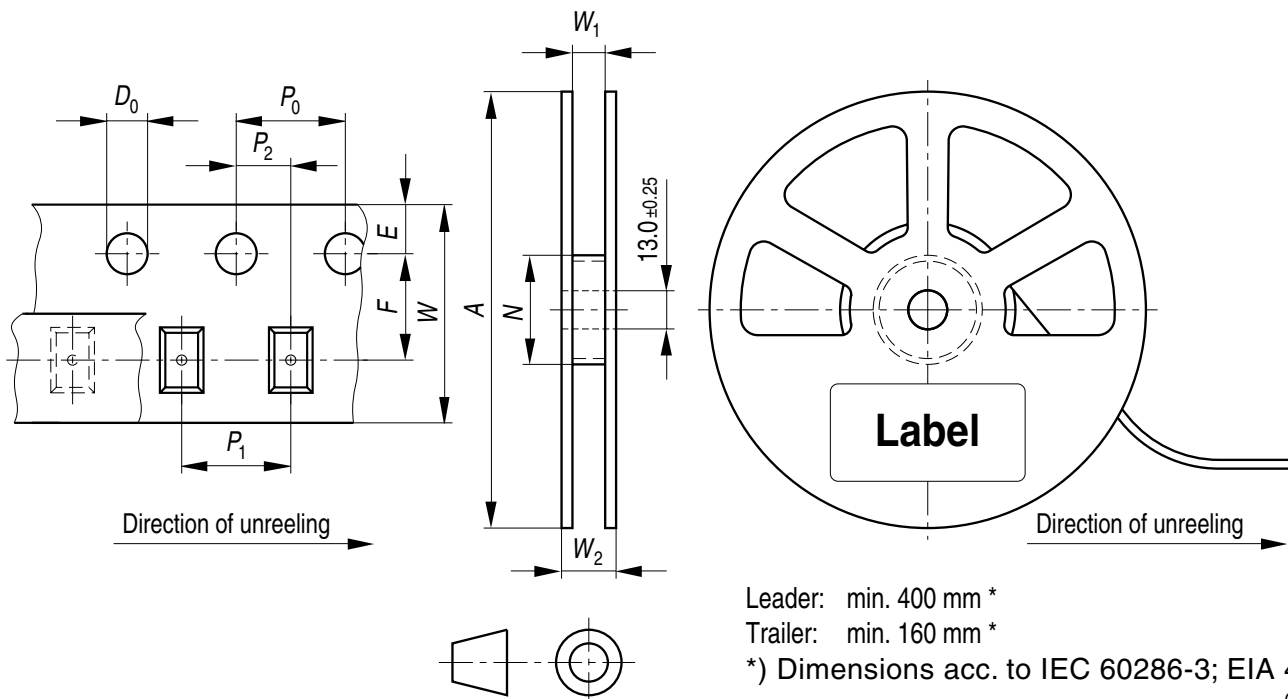

Tape dimensions [mm]

W	P ₀	P ₁	P ₂	D ₀	E	F
8 + 0.3 / -0.1	4 ± 0.1	2 ± 0.05 or 4 ± 0.1	2 ± 0.05	1.5 ± 0.1	1.75 ± 0.1	3.5 ± 0.05

Reel dimensions [mm]

A	W	N _{min}	W ₁	W _{2max}
180	8	60	8.4 + 2	14.4

Barcode-Product-Label (BPL)

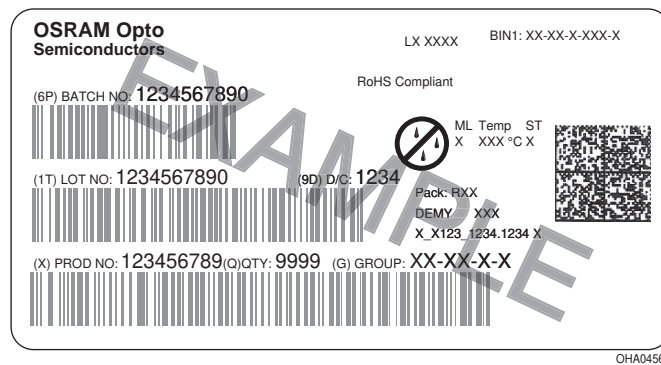

Dry Packing Process and Materials

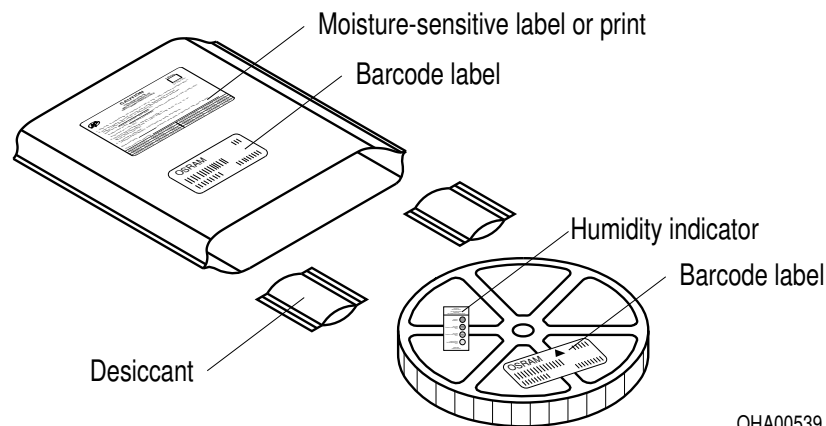

Note:

Moisture-sensitive product is packed in a dry bag containing desiccant and a humidity card. Regarding dry pack you will find further information in the internet. Here you will also find the normative references like JEDEC.

Transportation Packing and Materials

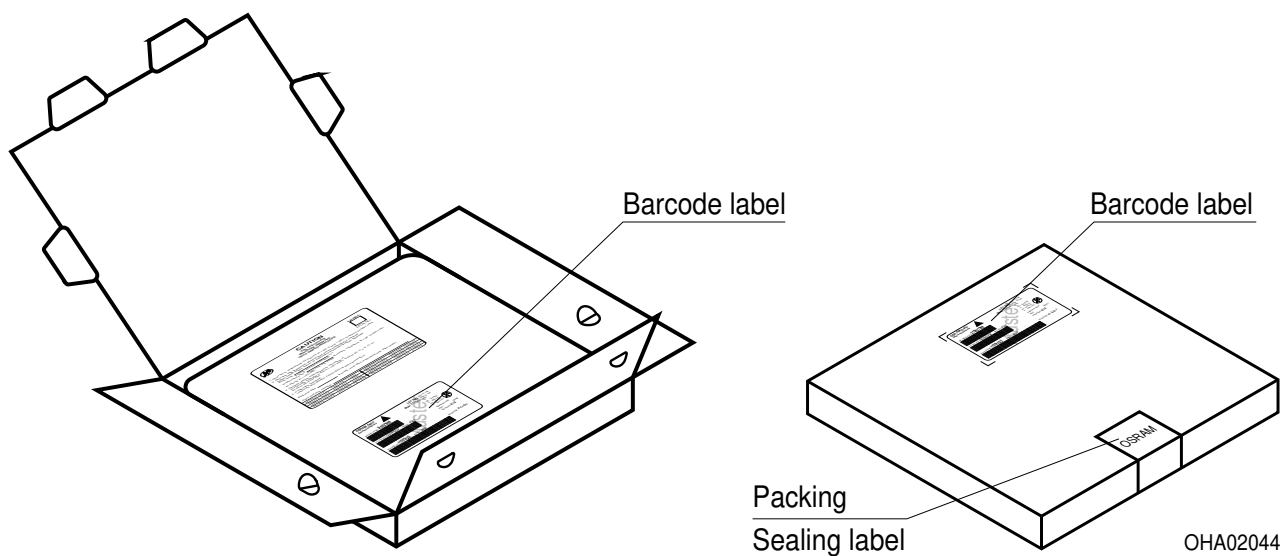

Dimensions of transportation box in mm

Width	Length	Height
200 ± 5	195 ± 5	30 ± 5

Disclaimer

Language english will prevail in case of any discrepancies or deviations between the two language wordings.

Attention please!

The information describes the type of component and shall not be considered as assured characteristics.

Terms of delivery and rights to change design reserved. Due to technical requirements components may contain dangerous substances.

For information on the types in question please contact our Sales Organization.

If printed or downloaded, please find the latest version in the Internet.

Packing

Please use the recycling operators known to you. We can also help you – get in touch with your nearest sales office.

By agreement we will take packing material back, if it is sorted. You must bear the costs of transport. For packing material that is returned to us unsorted or which we are not obliged to accept, we shall have to invoice you for any costs incurred.

Components used in life-support devices or systems must be expressly authorized for such purpose!

Critical components* may only be used in life-support devices** or systems with the express written approval of OSRAM OS.

*) A critical component is a component used in a life-support device or system whose failure can reasonably be expected to cause the failure of that life-support device or system, or to affect its safety or the effectiveness of that device or system.

**) Life support devices or systems are intended (a) to be implanted in the human body, or (b) to support and/or maintain and sustain human life. If they fail, it is reasonable to assume that the health and the life of the user may be endangered.

Glossary

- ¹⁾ **Typical Values:** Due to the special conditions of the manufacturing processes of LED, the typical data or calculated correlations of technical parameters can only reflect statistical figures. These do not necessarily correspond to the actual parameters of each single product, which could differ from the typical data and calculated correlations or the typical characteristic line. If requested, e.g. because of technical improvements, these typ. data will be changed without any further notice.

Published by OSRAM Opto Semiconductors GmbH
Leibnizstraße 4, D-93055 Regensburg
www.osram-os.com © All Rights Reserved.

EU RoHS and China RoHS compliant product



此产品符合欧盟 RoHS 指令的要求；
按照中国的相关法规和标准，不含有毒有害物质或元素。