



Chipsmall Limited consists of a professional team with an average of over 10 year of expertise in the distribution of electronic components. Based in Hongkong, we have already established firm and mutual-benefit business relationships with customers from,Europe,America and south Asia,supplying obsolete and hard-to-find components to meet their specific needs.

With the principle of “Quality Parts,Customers Priority,Honest Operation,and Considerate Service”,our business mainly focus on the distribution of electronic components. Line cards we deal with include Microchip,ALPS,ROHM,Xilinx,Pulse,ON,Everlight and Freescale. Main products comprise IC,Modules,Potentiometer,IC Socket,Relay,Connector.Our parts cover such applications as commercial,industrial, and automotives areas.

We are looking forward to setting up business relationship with you and hope to provide you with the best service and solution. Let us make a better world for our industry!



## Contact us

Tel: +86-755-8981 8866 Fax: +86-755-8427 6832

Email & Skype: info@chipsmall.com Web: www.chipsmall.com

Address: A1208, Overseas Decoration Building, #122 Zhenhua RD., Futian, Shenzhen, China



# Silicon NPN Phototransistor

## Version 1.3

### SFH 309



#### Features:

- **Spectral range of sensitivity:** (typ) 380 ... 1150 nm
- **Package:** 3mm Radial (T 1), Epoxy
- **Special:** High photosensitivity
- High linearity
- Available in groups

#### Applications

- Photointerrupters
- Industrial electronics
- For control and drive circuits

#### Ordering Information

Type:	Photocurrent $I_{PCE}$ [ $\mu$ A] $\lambda = 950 \text{ nm}$ , $E_e = 0.5 \text{ mW/cm}^2$ , $V_{CE} = 5 \text{ V}$	Ordering Code
SFH 309	400 ... 5000	Q62702P0859
SFH 309-3/4	630 ... 2000	Q62702P3592
SFH 309-4	1000 ... 2000	Q62702P0998
SFH 309-4/5	1000 ... 3200	Q62702P3593
SFH 309-5	1600 ... 3200	Q62702P0999
SFH 309-5/6	1600 ... 5000	Q62702P3594

*Note:* Only one bin within one packing unit (variation less than 2:1)

**Maximum Ratings** ( $T_A = 25\text{ °C}$ )

Parameter	Symbol	Values	Unit
Operating and storage temperature range	$T_{op}; T_{stg}$	-40 ... 100	°C
Collector-emitter voltage	$V_{CE}$	35	V
Collector current	$I_C$	15	mA
Collector surge current ( $\tau < 10\ \mu\text{s}$ )	$I_{CS}$	75	mA
Total Power dissipation	$P_{tot}$	165	mW
Thermal resistance	$R_{thJA}$	450	K / W
ESD withstand voltage (acc. to ANSI/ ESDA/ JEDEC JS-001 - HBM)	$V_{ESD}$	2000	V

**Characteristics** ( $T_A = 25\text{ °C}$ )

Parameter		Symbol	Values	Unit
Wavelength of max. sensitivity	(typ)	$\lambda_{S\ max}$	860	nm
Spectral range of sensitivity	(typ)	$\lambda_{10\%}$	(typ) 380 ... 1150	nm
Radiant sensitive area ( $\varnothing 220\ \mu\text{m}$ )	(typ)	A	0.038	mm <sup>2</sup>
Dimensions of chip area	(typ)	L x W	(typ) 0.45 x 0.45	mm x mm
Distance chip front to case surface	(min ... max)	H	(min ... max) 2.4 ... 2.8	mm
Half angle	(typ)	$\varphi$	$\pm 12$	°
Capacitance ( $V_{CE} = 0\ \text{V}$ , $f = 1\ \text{MHz}$ , $E = 0$ )	(typ)	$C_{CE}$	5	pF
Dark current ( $V_{CE} = 20\ \text{V}$ , $E = 0$ )	(typ (max))	$I_{CE0}$	1 ( $\leq 50$ )	nA

Grouping ( $T_A = 25\text{ °C}$ ,  $\lambda = 950\text{ nm}$ )

Group	Min Photocurrent $E_e = 0.5\text{ mW/cm}^2$ , $V_{CE} = 5\text{ V}$ $I_{PCE, min}\text{ }[\mu\text{A}]$	Max Photocurrent $E_e = 0.5\text{ mW/cm}^2$ , $V_{CE} = 5\text{ V}$ $I_{PCE, max}\text{ }[\mu\text{A}]$	Typ Photocurrent $E_V = 1000\text{ lx, Std. Light A, } V_{CE} = 5\text{ V}$ $I_{PCE}\text{ }[\mu\text{A}]$	Rise and fall time $I_C = 1\text{ mA, } V_{CC} = 5\text{ V, } R_L = 1\text{ k}\Omega$ $t_r, t_f\text{ }[\mu\text{s}]$
-2	400	800	1500	5
-3	630	1250	2800	6
-4	1000	2000	4500	7
-5	1600	3200	7200	8
-6	2500	5000	11200	9

Group	Collector-emitter saturation voltage $I_C = I_{PCEmin} \times 0.3, E_e = 0.5\text{ mW/cm}^2$ $V_{CEsat}\text{ }[\text{mV}]$
-2	200
-3	200
-4	200
-5	200
-6	200

Note.:  $I_{PCEmin}$  is the min. photocurrent of the specified group.

**Relative Spectral Sensitivity** <sup>1) page 9</sup>

$S_{rel} = f(\lambda)$

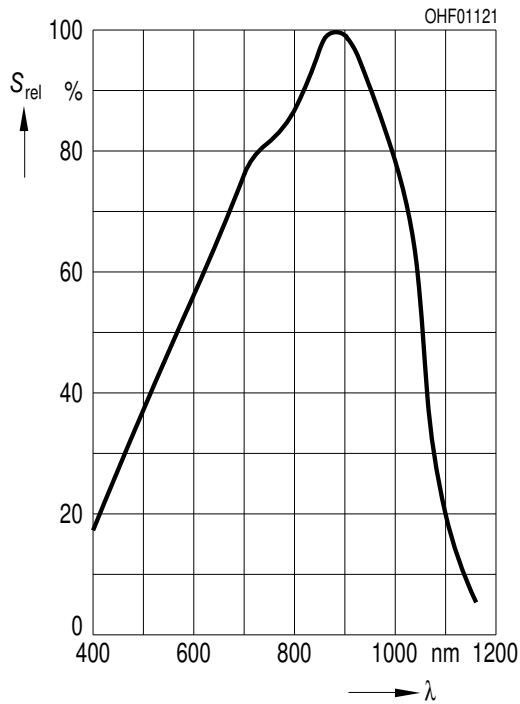

**Photocurrent** <sup>1) page 9</sup>

$I_{PCE} = f(E_e), V_{CE} = 5 V$

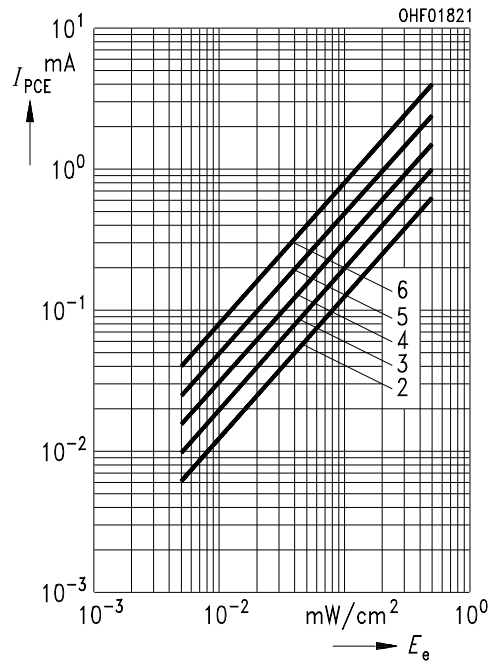

**Photocurrent** <sup>1) page 9</sup>

$I_{PCE} = f(V_{CE}), E_e = \text{Parameter}$

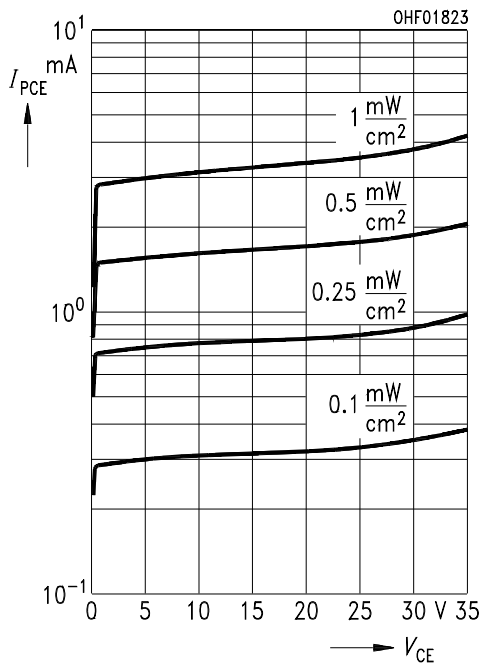

**Photocurrent** <sup>1) page 9</sup>

$I_{PCE} / I_{PCE}(25^\circ C) = f(T_A), V_{CE} = 5 V$

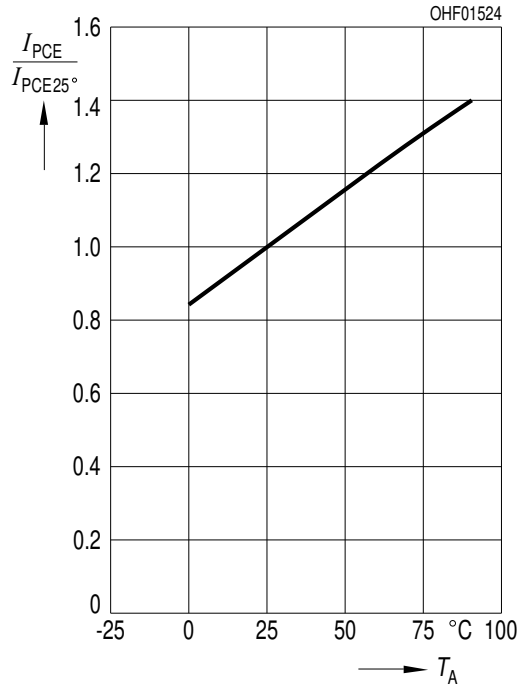

**Dark Current** <sup>1) page 9</sup>

$I_{CE0} = f(V_{CE}), E = 0$

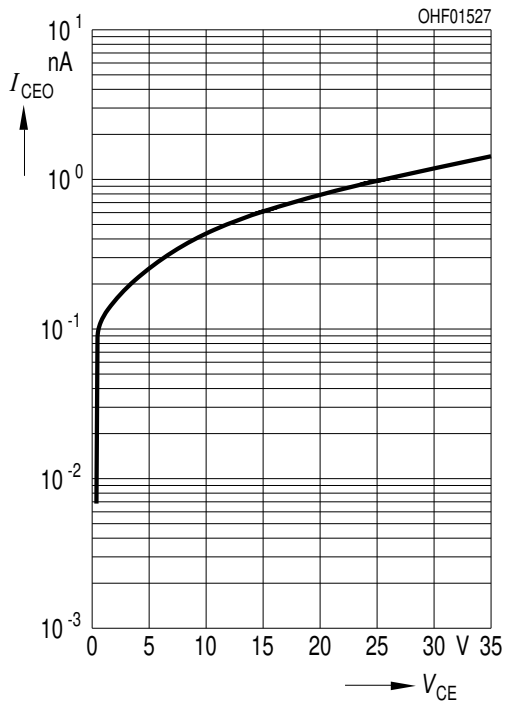

**Dark Current** <sup>1) page 9</sup>

$I_{CE0} = f(T_A), V_{CE} = 20 \text{ V}, E = 0$

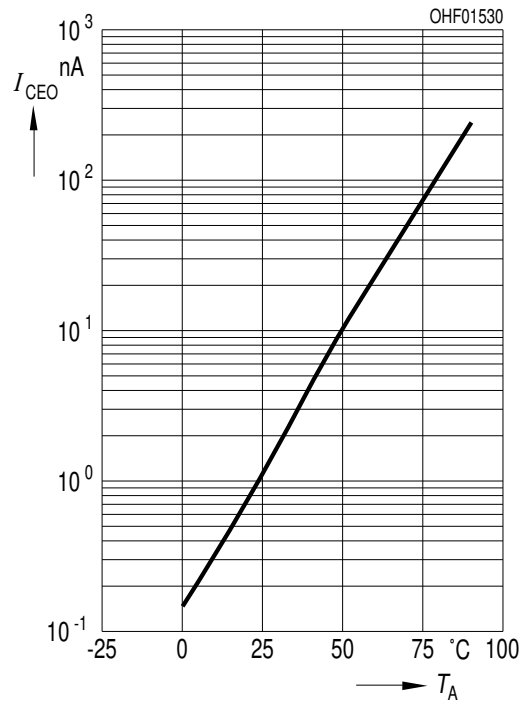

**Collector-Emitter Capacitance** <sup>1) page 9</sup>

$C_{CE} = f(V_{CE}), f = 1 \text{ MHz}, E = 0$

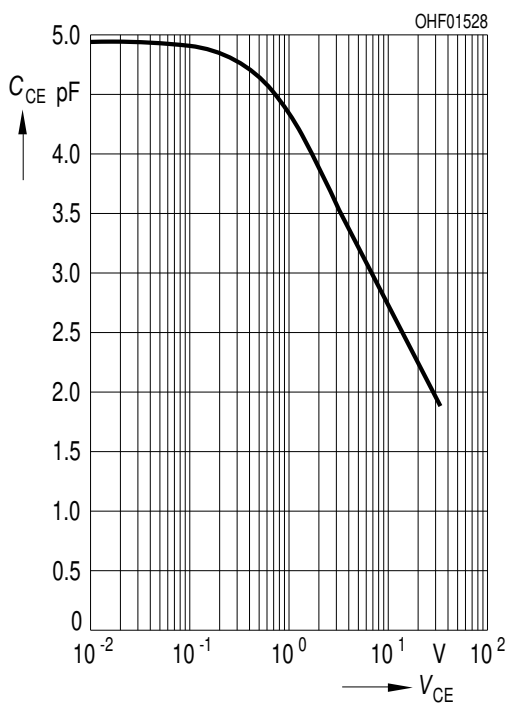

**Power Consumption**

$P_{tot} = f(T_A)$

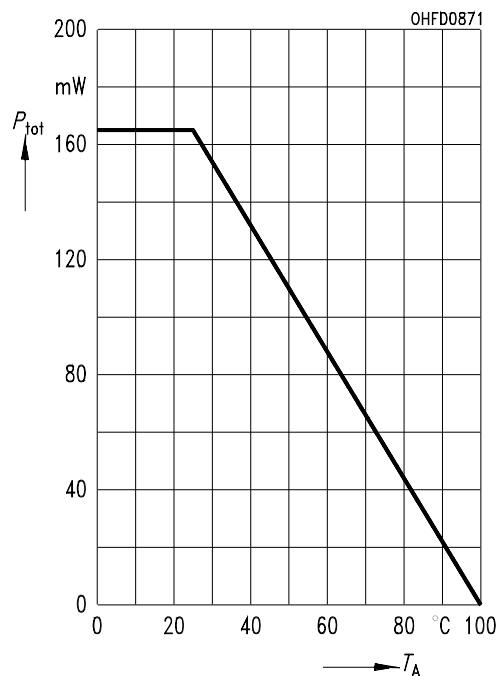

**Directional Characteristics** <sup>1) page 9</sup>

$S_{rel} = f(\phi)$

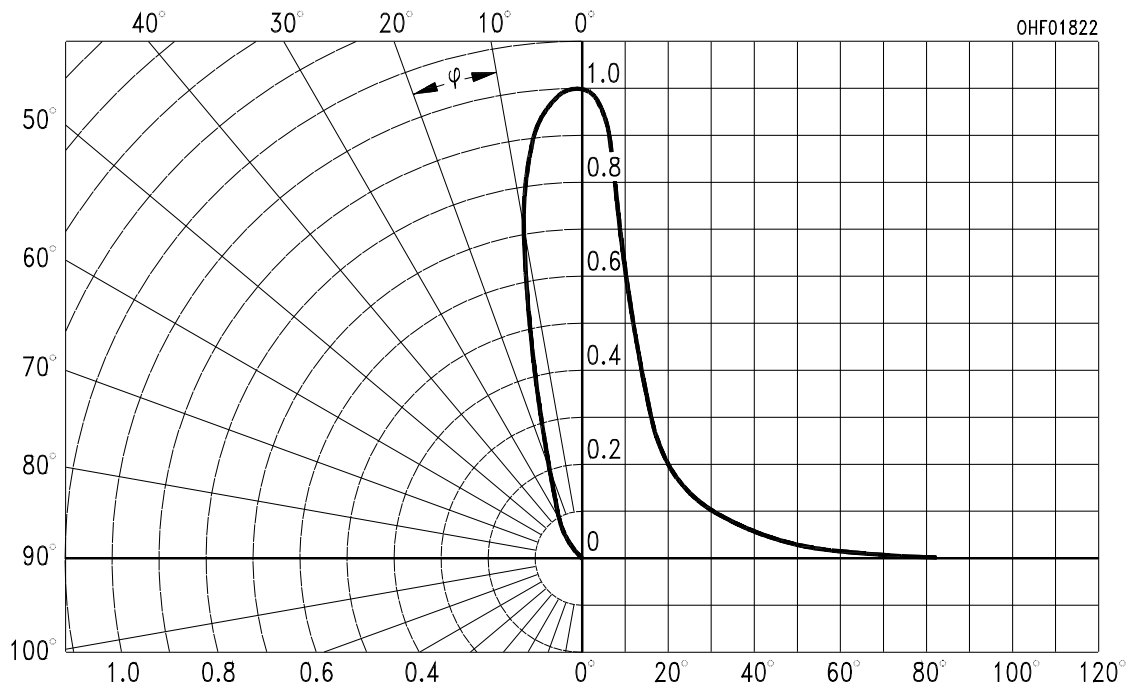

**Package Outline**

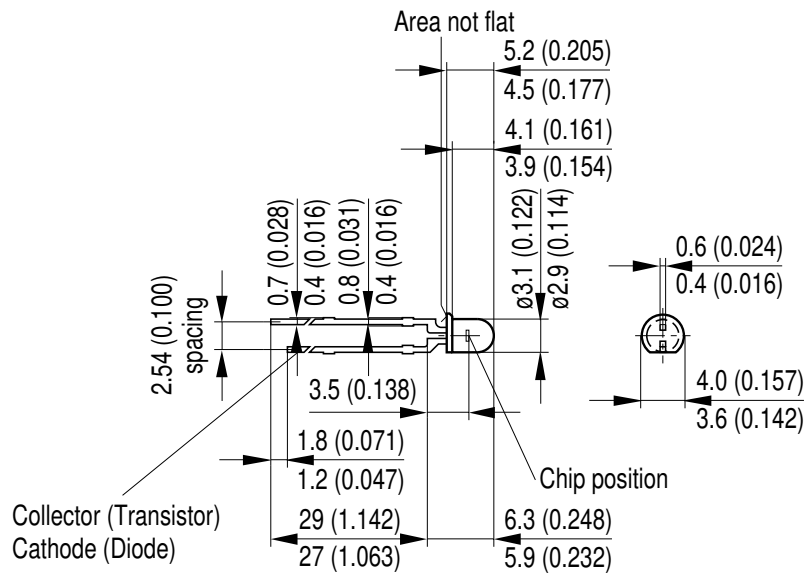

GEOY6653

*Dimensions in mm (inch).*

**Package**

3mm Radial (T 1), Epoxy

**Approximate Weight:**

0.2 g

**Note**

Packing information is available on the internet (online product catalog).

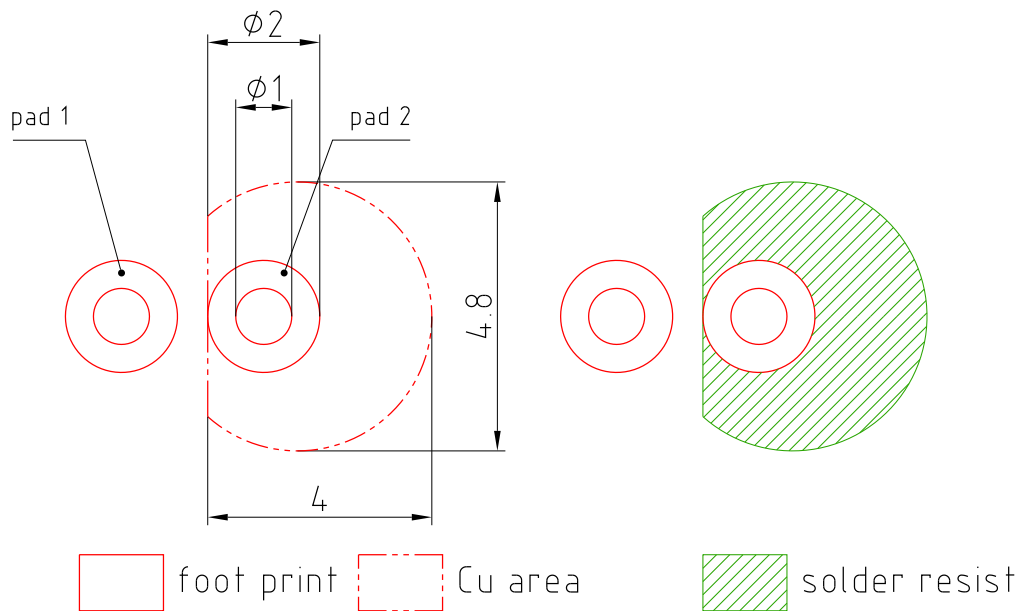
**Recommended Solder Pad**

E062.3010.188-01

Dimensions in mm.

**Note:**

pad 1: emitter



**TTW Soldering**

IEC-61760-1 TTW

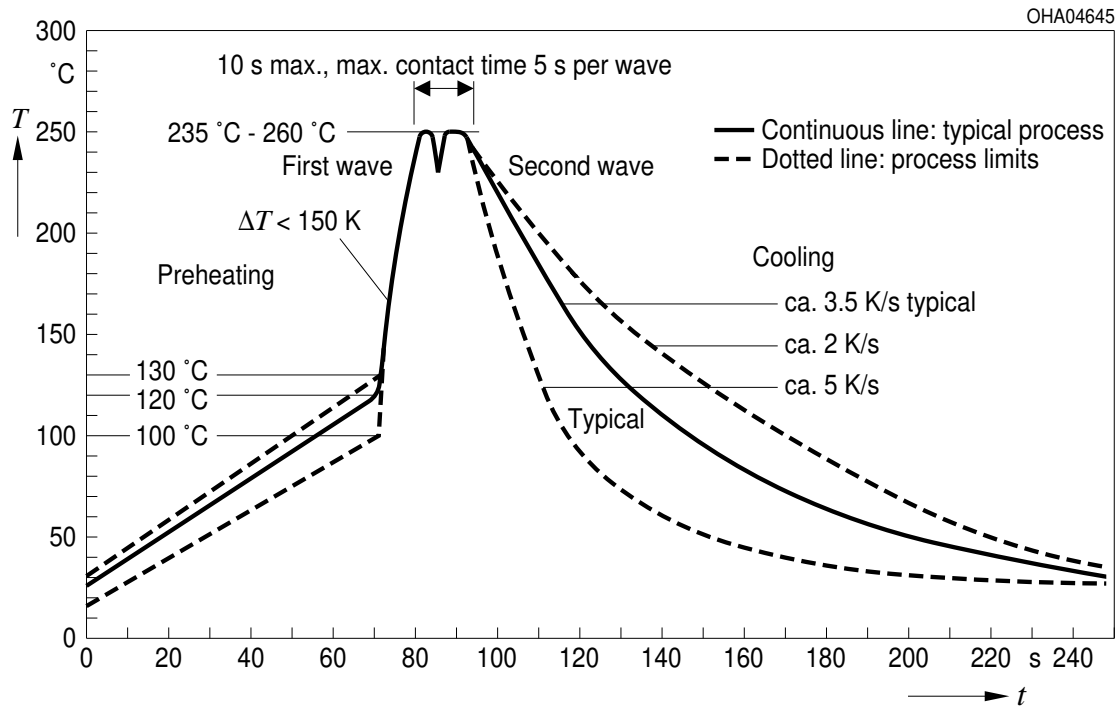
**Disclaimer**

Language english will prevail in case of any discrepancies or deviations between the two language wordings.

**Attention please!**

The information describes the type of component and shall not be considered as assured characteristics.

Terms of delivery and rights to change design reserved. Due to technical requirements components may contain dangerous substances.

For information on the types in question please contact our Sales Organization.

If printed or downloaded, please find the latest version in the Internet.

**Packing**

Please use the recycling operators known to you. We can also help you – get in touch with your nearest sales office. By agreement we will take packing material back, if it is sorted. You must bear the costs of transport. For packing material that is returned to us unsorted or which we are not obliged to accept, we shall have to invoice you for any costs incurred.

**Components used in life-support devices or systems must be expressly authorized for such purpose!**

Critical components\* may only be used in life-support devices\*\* or systems with the express written approval of OSRAM OS.

\*) A critical component is a component used in a life-support device or system whose failure can reasonably be expected to cause the failure of that life-support device or system, or to affect its safety or the effectiveness of that device or system.

\*\*) Life support devices or systems are intended (a) to be implanted in the human body, or (b) to support and/or maintain and sustain human life. If they fail, it is reasonable to assume that the health and the life of the user may be endangered.

**Glossary**

- <sup>1)</sup> **Typical Values:** Due to the special conditions of the manufacturing processes of LED, the typical data or calculated correlations of technical parameters can only reflect statistical figures. These do not necessarily correspond to the actual parameters of each single product, which could differ from the typical data and calculated correlations or the typical characteristic line. If requested, e.g. because of technical improvements, these typ. data will be changed without any further notice.

**Published by OSRAM Opto Semiconductors GmbH**  
**Leibnizstraße 4, D-93055 Regensburg**  
**www.osram-os.com © All Rights Reserved.**

EU RoHS and China RoHS compliant product



此产品符合欧盟 RoHS 指令的要求；  
按照中国的相关法规和标准，不含有毒有害物质或元素。