



Chipsmall Limited consists of a professional team with an average of over 10 year of expertise in the distribution of electronic components. Based in Hongkong, we have already established firm and mutual-benefit business relationships with customers from,Europe,America and south Asia,supplying obsolete and hard-to-find components to meet their specific needs.

With the principle of "Quality Parts,Customers Priority,Honest Operation,and Considerate Service",our business mainly focus on the distribution of electronic components. Line cards we deal with include Microchip,ALPS,ROHM,Xilinx,Pulse,ON,Everlight and Freescale. Main products comprise IC,Modules,Potentiometer,IC Socket,Relay,Connector.Our parts cover such applications as commercial,industrial, and automotives areas.

We are looking forward to setting up business relationship with you and hope to provide you with the best service and solution. Let us make a better world for our industry!



Contact us

Tel: +86-755-8981 8866 Fax: +86-755-8427 6832

Email & Skype: info@chipsmall.com Web: www.chipsmall.com

Address: A1208, Overseas Decoration Building, #122 Zhenhua RD., Futian, Shenzhen, China



Optocoupler, Phototransistor Output, Low Input Current, with Base Connection, 5300 V_{RMS}

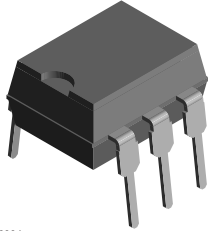

I179004

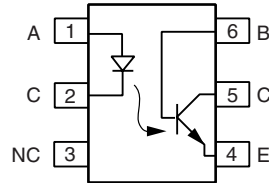

DESCRIPTION

The SFH608 is an optocoupler designed for high current transfer ratio at low input currents with the output transistor saturated. This makes the device ideal for low current switching applications. The SFH608 is packaged in a six pin plastic DIP.

AGENCY APPROVALS

- UL1577, file no. E52744 system code H or J, double protection
- DIN EN 60747-5-5 (VDE 0884) available with option 1
- CSA 93751
- BSI IEC 60950; IEC 60065

FEATURES

- Very high CTR at $I_F = 1.0 \text{ mA}$, $V_{CE} = 0.5 \text{ V}$
- Specified minimum CTR at $I_F = 0.5 \text{ mA}$
- $V_{CE} = 1.5 \text{ V} \geq 32 \%$ (typ. 120 %)
- Good CTR linearity with forward current
- Low CTR degradation
- High collector-emitter voltage, $V_{CEO} = 55 \text{ V}$
- Isolation test voltage: 5300 V_{RMS}
- Low current input
- Low coupling capacitance
- High common mode transient immunity
- Lead (Pb)-free component
- Component in accordance to RoHS 2002/95/EC and WEEE 2002/96/EC

RoHS
COMPLIANT

APPLICATIONS

- Telecommunications
- Industrial controls
- Office machines
- Microprocessor system interfaces

ORDER INFORMATION

PART	REMARKS
SFH608-2	CTR 63 % to 125 %, DIP-6
SFH608-3	CTR 100 % to 200 %, DIP-6
SFH608-4	CTR 160 % to 320 %, DIP-6
SFH608-5	CTR 250 % to 500 %, DIP-6
SFH608-2-X006	CTR 63 % to 125 %, DIP-6 400 mil (option 6)
SFH608-2-X007	CTR 63 % to 125 %, SMD-6 (option 7)
SFH608-2-X009	CTR 63 % to 125 %, SMD-6 (option 9)
SFH608-3-X006	CTR 100 % to 200 %, DIP-6 400 mil (option 6)
SFH608-3-X007	CTR 100 % to 200 %, SMD-6 (option 7)
SFH608-4-X006	CTR 160 % to 320 %, DIP-6 400 mil (option 6)
SFH608-4-X007	CTR 160 % to 320 %, SMD-6 (option 7)
SFH608-5-X007	CTR 250 % to 500 %, SMD-6 (option 7)

Note

For additional information on the available options refer to option information.

Vishay Semiconductors Optocoupler, Phototransistor Output,
Low Input Current, with Base
Connection, 5300 V_{RMS}

ABSOLUTE MAXIMUM RATINGS (1)				
PARAMETER	TEST CONDITION	SYMBOL	VALUE	UNIT
INPUT				
Reverse voltage		V _R	6	V
DC forward current		I _F	50	mA
Surge forward current	t _p ≤ 10 μs	I _{FSM}	2.5	A
Total power dissipation		P _{diss}	70	mW
OUTPUT				
Collector emitter voltage		V _{CE}	55	V
Collector base voltage		V _{CB0}	55	V
Emitter base voltage		V _{EBO}	7	V
Collector current		I _C	50	mA
Surge collector current	t _p ≤ 1.0 ms		100	mA
Total power dissipation		P _{diss}	150	mW
COUPLER				
Isolation test voltage between emitter and detector	t = 1.0 s	V _{ISO}	5300	V _{RMS}
Creepage distance			≥ 7	mm
Clearance distance			≥ 7	mm
Comparative tracking index per DIN IEC 112/VDE0303, part 1			175	
Isolation resistance	V _{IO} = 500 V, T _{amb} = 25 °C	R _{IO}	≥ 10 ¹²	Ω
	V _{IO} = 500 V, T _{amb} = 100 °C	R _{IO}	≥ 10 ¹¹	Ω
Storage temperature range		T _{stg}	- 55 to + 150	°C
Operating temperature range		T _{amb}	- 55 to + 100	°C
Soldering temperature (2)	max. 10 s, dip soldering: distance to seating plane ≥ 1.5 mm	T _{sld}	260	°C

Notes

(1) T_{amb} = 25 °C, unless otherwise specified.

Stresses in excess of the absolute maximum ratings can cause permanent damage to the device. Functional operation of the device is not implied at these or any other conditions in excess of those given in the operational sections of this document. Exposure to absolute maximum ratings for extended periods of the time can adversely affect reliability.

(2) Refer to reflow profile for soldering conditions for surface mounted devices (SMD). Refer to wave profile for soldering conditions for through hole devices (DIP).

ELECTRICAL CHARACTERISTICS							
PARAMETER	TEST CONDITION	PART	SYMBOL	MIN.	TYP.	MAX.	UNIT
INPUT							
Forward voltage	I _F = 5 mA		V _F		1.1	1.5	V
Reverse voltage	I _R = 10 μA		V _R	6			V
Reverse current	V _R = 6 V		I _R		0.01	10	μA
Capacitance	V _R = 0 V, f = 1 MHz		C _O		25		pF
Thermal resistance			R _{thja}		1070		K/W
OUTPUT							
Collector emitter voltage	I _{CE} = 10 μA		V _{CEO}	55			V
Emitter base voltage	I _{EB} = 10 μA		V _{EBO}	7			V
Collector emitter capacitance	V _{CE} = 5 V, f = 1 MHz		C _{CE}		10		pF
Collector base capacitance	V _{CE} = 5 V, f = 1 MHz		C _{CB}		16		pF
Emitter base capacitance	V _{CE} = 5 V, f = 1 MHz		C _{EB}		10		pF
Thermal resistance			R _{thja}		500		K/W
Collector emitter leakage current	V _{CE} = 10 V		I _{CEO}		10	200	nA



Optocoupler, Phototransistor Output, Vishay Semiconductors
 Low Input Current, with Base
 Connection, 5300 V_{RMS}

ELECTRICAL CHARACTERISTICS							
PARAMETER	TEST CONDITION	PART	SYMBOL	MIN.	TYP.	MAX.	UNIT
COUPLER							
Coupling capacitance			C _C		0.6		pF
Saturation voltage, collector emitter	I _C = 0.32 mA, I _F = 1 mA	SFH608-2	V _{CEsat}		0.25	0.4	V
	I _C = 0.5 mA, I _F = 1 mA	SFH608-3	V _{CEsat}		0.25	0.4	V
	I _C = 0.8 mA, I _F = 1 mA	SFH608-4	V _{CEsat}		0.25	0.4	V
	I _C = 1.25 mA, I _F = 1 mA	SFH608-5	V _{CEsat}		0.25	0.4	V

Note

T_{amb} = 25 °C, unless otherwise specified.

Minimum and maximum values are testing requirements. Typical values are characteristics of the device and are the result of engineering evaluation. Typical values are for information only and are not part of the testing requirements.

CURRENT TRANSFER RATIO							
PARAMETER	TEST CONDITION	PART	SYMBOL	MIN.	TYP.	MAX.	UNIT
Coupling transfer ratio	I _F = 1 mA, V _{CC} = 0.5 V	SFH608-2	CTR	63		125	%
	I _F = 0.5 mA, V _{CC} = 1.5 V	SFH608-2	CTR	32	75		%
	I _F = 1 mA, V _{CC} = 0.5 V	SFH608-3	CTR	100		200	%
	I _F = 0.5 mA, V _{CC} = 1.5 V	SFH608-3	CTR	50	120		%
	I _F = 1 mA, V _{CC} = 0.5 V	SFH608-4	CTR	160		320	%
	I _F = 0.5 mA, V _{CC} = 1.5 V	SFH608-4	CTR	80	200		%
	I _F = 1 mA, V _{CC} = 0.5 V	SFH608-5	CTR	250		500	%
	I _F = 0.5 mA, V _{CC} = 1.5 V	SFH608-5	CTR	125	300		%

SWITCHING CHARACTERISTICS							
PARAMETER	TEST CONDITION	SYMBOL	MIN.	TYP.	MAX.	UNIT	
Turn-on time	I _C = 2 mA (to adjust by I _F), R _L = 100 Ω, V _{CC} = 5 V	t _{on}		8		μs	
Rise time	I _C = 2 mA (to adjust by I _F), R _L = 100 Ω, V _{CC} = 5 V	t _r		5		μs	
Turn-off time	I _C = 2 mA (to adjust by I _F), R _L = 100 Ω, V _{CC} = 5 V	t _{off}		7.5		μs	
Fall time	I _C = 2 mA (to adjust by I _F), R _L = 100 Ω, V _{CC} = 5 V	t _f		7		μs	

SAFETY AND INSULATION RATINGS							
PARAMETER	TEST CONDITION	SYMBOL	MIN.	TYP.	MAX.	UNIT	
Climatic classification (according to IEC 68 part 1)				55/100/21			
Comparative tracking index		CTI	175		399		
V _{IOTM}			8000			V	
V _{IORM}			890			V	
P _{SO}					700	mW	
I _{SI}					400	mA	
T _{SI}					175	°C	
Creepage distance	standard DIP-6		7			mm	
Clearance distance	standard DIP-6		7			mm	
Creepage distance	400 mil DIP-6		8			mm	
Clearance distance	400 mil DIP-6		8			mm	
Insulation thickness, reinforced rated	per IEC 60950 2.10.5.1		0.4			mm	

Note

As per IEC 60747-5-2, § 7.4.3.8.1, this optocoupler is suitable for "safe electrical insulation" only within the safety ratings. Compliance with the safety ratings shall be ensured by means of protective circuits.

TYPICAL CHARACTERISTICS

T_{amb} = 25 °C, unless otherwise specified

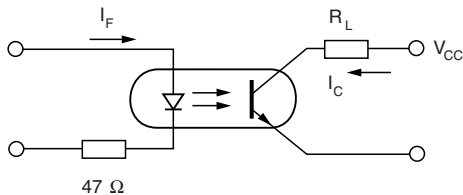

isfh608_01

Fig. 1 - Switching Schematic

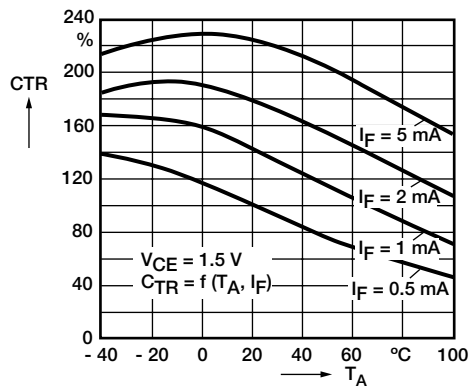

isfh608_04

Fig. 4 - Current Transfer Ratio (typ.)

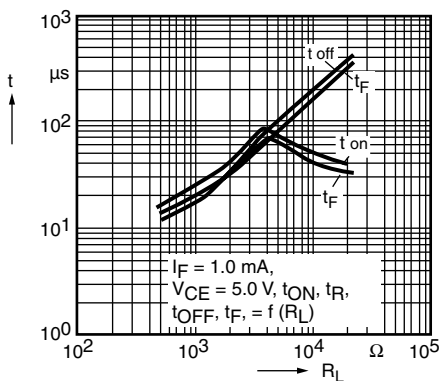

isfh608_02

Fig. 2 - Switching Times

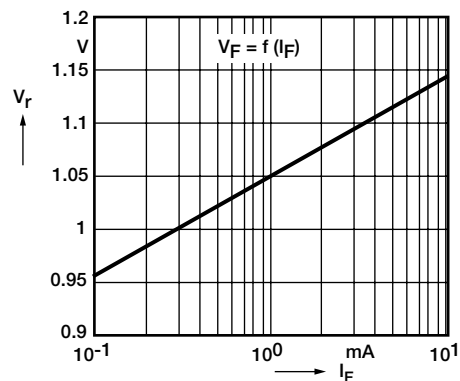

isfh608_05

Fig. 5 - Diode Forward Voltage (typ.)

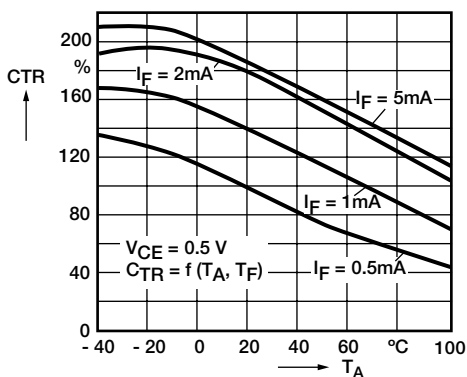

isfh608_03

Fig. 3 - Current Transfer Ratio (typ.)

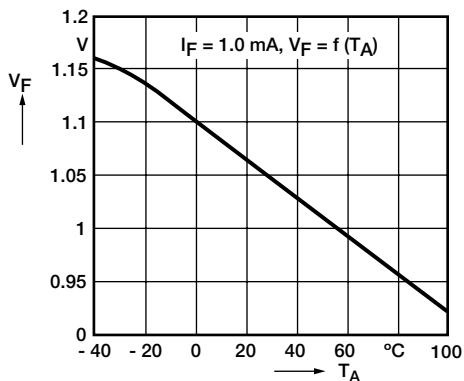

isfh608_06

Fig. 6 - Diode Forward Voltage (typ.)

Optocoupler, Phototransistor Output, Vishay Semiconductors
 Low Input Current, with Base
 Connection, 5300 V_{RMS}

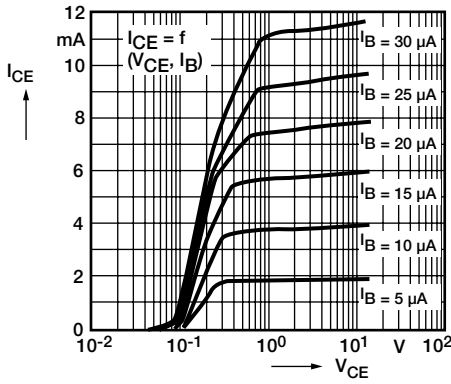

isfh608_07

Fig. 7 - Output Characteristics

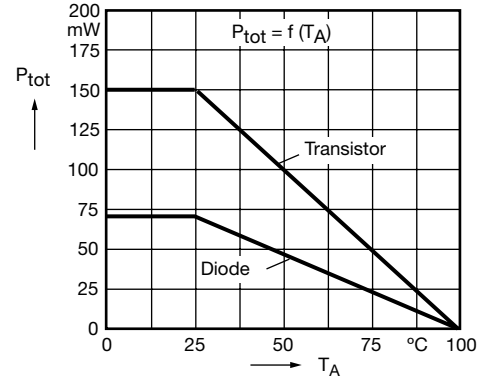

isfh608_10

Fig. 10 - Permissible Power Dissipation for Transistor and Diode

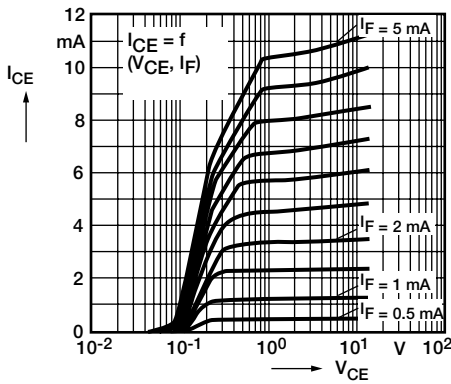

isfh608_08

Fig. 8 - Output Characteristics

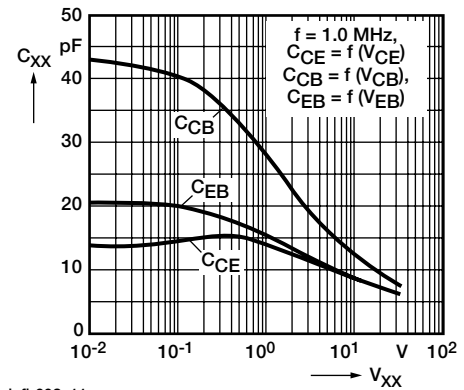

isfh608_11

Fig. 11 - Transistor Capacitance

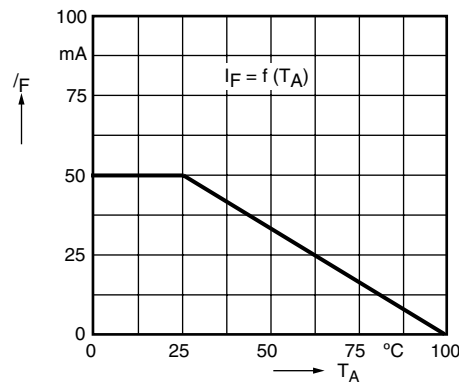

isfh608_09

Fig. 9 - Permissible Forward Current Diode

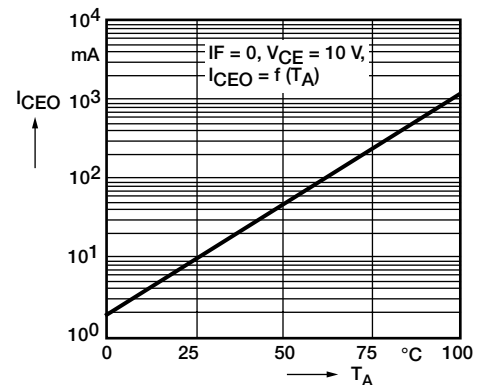

isfh608_12

Fig. 12 - Collector Emitter Leakage Current vs. Temperature

SFH608



Vishay Semiconductors Optocoupler, Phototransistor Output,
Low Input Current, with Base
Connection, 5300 V_{RMS}

PACKAGE DIMENSIONS in inches (millimeters)

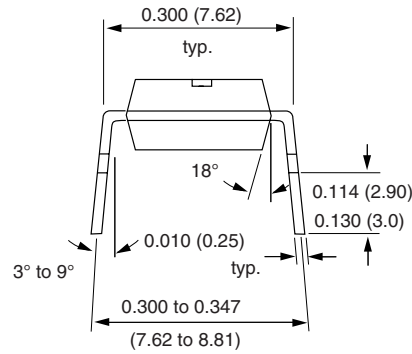
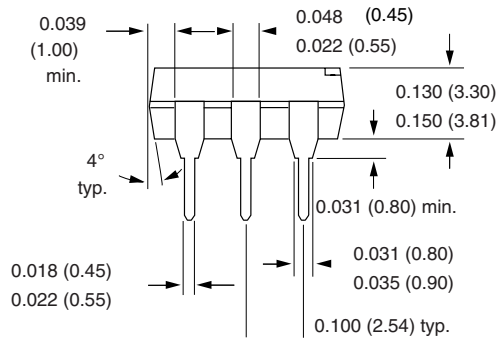
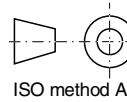
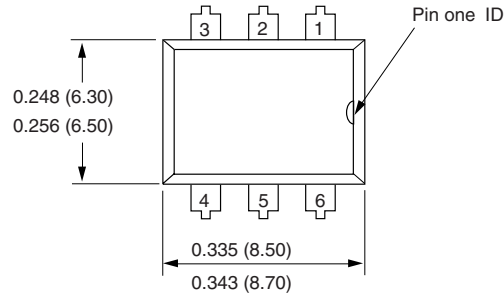

i178004

Option 6

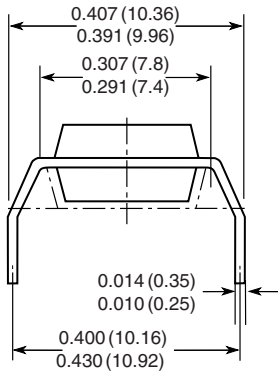

Option 7

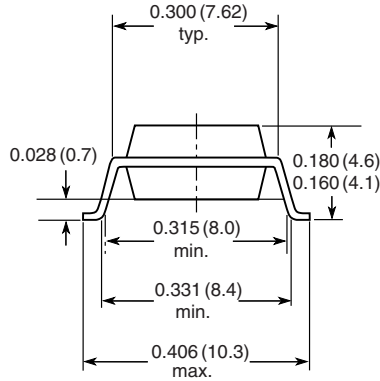

Option 9

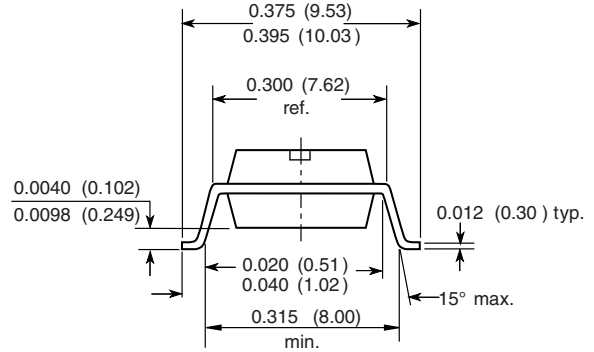

18450



Optocoupler, Phototransistor Output, Vishay Semiconductors
Low Input Current, with Base
Connection, 5300 V_{RMS}

OZONE DEPLETING SUBSTANCES POLICY STATEMENT

It is the policy of Vishay Semiconductor GmbH to

1. Meet all present and future national and international statutory requirements.
2. Regularly and continuously improve the performance of our products, processes, distribution and operating systems with respect to their impact on the health and safety of our employees and the public, as well as their impact on the environment.

It is particular concern to control or eliminate releases of those substances into the atmosphere which are known as ozone depleting substances (ODSs).

The Montreal Protocol (1987) and its London Amendments (1990) intend to severely restrict the use of ODSs and forbid their use within the next ten years. Various national and international initiatives are pressing for an earlier ban on these substances.

Vishay Semiconductor GmbH has been able to use its policy of continuous improvements to eliminate the use of ODSs listed in the following documents.

1. Annex A, B and list of transitional substances of the Montreal Protocol and the London Amendments respectively.
2. Class I and II ozone depleting substances in the Clean Air Act Amendments of 1990 by the Environmental Protection Agency (EPA) in the USA.
3. Council Decision 88/540/EEC and 91/690/EEC Annex A, B and C (transitional substances) respectively.

Vishay Semiconductor GmbH can certify that our semiconductors are not manufactured with ozone depleting substances and do not contain such substances.

We reserve the right to make changes to improve technical design
and may do so without further notice.

Parameters can vary in different applications. All operating parameters must be validated for each customer application by the customer. Should the buyer use Vishay Semiconductors products for any unintended or unauthorized application, the buyer shall indemnify Vishay Semiconductors against all claims, costs, damages, and expenses, arising out of, directly or indirectly, any claim of personal damage, injury or death associated with such unintended or unauthorized use.

Vishay Semiconductor GmbH, P.O.B. 3535, D-74025 Heilbronn, Germany



Disclaimer

All product specifications and data are subject to change without notice.

Vishay Intertechnology, Inc., its affiliates, agents, and employees, and all persons acting on its or their behalf (collectively, "Vishay"), disclaim any and all liability for any errors, inaccuracies or incompleteness contained herein or in any other disclosure relating to any product.

Vishay disclaims any and all liability arising out of the use or application of any product described herein or of any information provided herein to the maximum extent permitted by law. The product specifications do not expand or otherwise modify Vishay's terms and conditions of purchase, including but not limited to the warranty expressed therein, which apply to these products.

No license, express or implied, by estoppel or otherwise, to any intellectual property rights is granted by this document or by any conduct of Vishay.

The products shown herein are not designed for use in medical, life-saving, or life-sustaining applications unless otherwise expressly indicated. Customers using or selling Vishay products not expressly indicated for use in such applications do so entirely at their own risk and agree to fully indemnify Vishay for any damages arising or resulting from such use or sale. Please contact authorized Vishay personnel to obtain written terms and conditions regarding products designed for such applications.

Product names and markings noted herein may be trademarks of their respective owners.