



Chipsmall Limited consists of a professional team with an average of over 10 year of expertise in the distribution of electronic components. Based in Hongkong, we have already established firm and mutual-benefit business relationships with customers from,Europe,America and south Asia,supplying obsolete and hard-to-find components to meet their specific needs.

With the principle of “Quality Parts,Customers Priority,Honest Operation,and Considerate Service”,our business mainly focus on the distribution of electronic components. Line cards we deal with include Microchip,ALPS,ROHM,Xilinx,Pulse,ON,Everlight and Freescale. Main products comprise IC,Modules,Potentiometer,IC Socket,Relay,Connector.Our parts cover such applications as commercial,industrial, and automotives areas.

We are looking forward to setting up business relationship with you and hope to provide you with the best service and solution. Let us make a better world for our industry!



Contact us

Tel: +86-755-8981 8866 Fax: +86-755-8427 6832

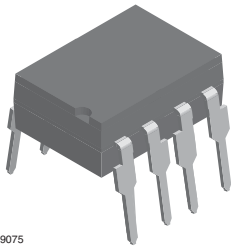
Email & Skype: info@chipsmall.com Web: www.chipsmall.com

Address: A1208, Overseas Decoration Building, #122 Zhenhua RD., Futian, Shenzhen, China

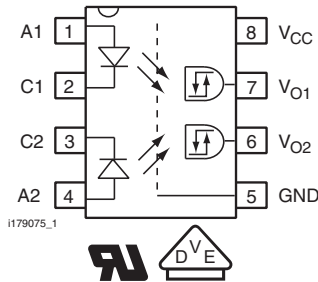




High Speed Optocoupler, Dual, 5 MBd



1179075



FEATURES

- Data rate 5 Mbits/s (2.5 Mbit/s over temperature)
- Buffer
- Isolation test voltage, 5300 V_{RMS}
- TTL, LSTTL and CMOS compatible
- Internal shield for very high common mode transient immunity
- Wide supply voltage range (4.5 V to 15 V)
- Low input current (1.6 mA to 5 mA)
- Specified from 0 °C to 85 °C
- Compliant to RoHS Directive to 2002/95/EC and in accordance WEEE 2002/96/EC



RoHS COMPLIANT

DESCRIPTION

The dual channel 5 Mb/s SFH6731 and SFH6732 high speed optocoupler consists of a GaAlAs infrared emitting diode, optically coupled with an integrated photo detector. The detector incorporates a Schmitt-Trigger stage for improved noise immunity. A Faraday shield provides a common mode transient immunity of 1000 V/μs at V_{CM} = 50 V for SFH6731 and 500 V/μs at V_{CM} = 300 V for SFH6732.

The SFH6731 and SFH6732 uses an industry standard DIP-8 package. With standard lead bending, creepage distance and clearance of ≥ 7 mm with lead bending options 6, 7 and 9 ≥ 8 mm are achieved.

AGENCY APPROVALS

- UL1577, file no. E52744 system code H, double protection
- DIN EN 60747-5-2 (VDE 0884)/DIN EN 60747-5-5 (pending), available with option 1

APPLICATIONS

- Industrial control
- Replace pulse transformers
- Routine logic interfacing
- Motion/power control
- High speed line receiver
- Microprocessor system interfaces
- Computer peripheral interfaces

ORDERING INFORMATION		
<div style="display: flex; justify-content: space-around;"> <div style="border: 1px solid black; padding: 2px;">S</div> <div style="border: 1px solid black; padding: 2px;">F</div> <div style="border: 1px solid black; padding: 2px;">H</div> <div style="border: 1px solid black; padding: 2px;">6</div> <div style="border: 1px solid black; padding: 2px;">7</div> <div style="border: 1px solid black; padding: 2px;">3</div> <div style="border: 1px solid black; padding: 2px;">#</div> <div style="border: 1px solid black; padding: 2px;">-</div> <div style="border: 1px solid black; padding: 2px;">X</div> <div style="border: 1px solid black; padding: 2px;">0</div> <div style="border: 1px solid black; padding: 2px;">#</div> <div style="border: 1px solid black; padding: 2px;">#</div> <div style="border: 1px solid black; padding: 2px;">T</div> </div>	PART NUMBER	PACKAGE OPTION
		TAPE AND REEL
AGENCY CERTIFIED/PACKAGE	CMR (kV/μs)	CMR (kV/μs)
UL	1	5
DIP-8	SFH6731	SFH6732
SMD-8, option 7	-	SFH6732-X007T
VDE, UL	1	5
SMD-8, option 7	SFH6731-X017T	-

TRUTH TABLE (positive logic)		
PARTS	IR DIODE	OUTPUT
SFH6731	On	H
	Off	L
SFH6732	On	H
	Off	L



ABSOLUTE MAXIMUM RATINGS (T _{amb} = 25 °C, unless otherwise specified)				
PARAMETER	TEST CONDITION	SYMBOL	VALUE	UNIT
INPUT				
Reverse voltage		V _R	3	V
DC Forward current		I _F	10	mA
Surge forward current	t _p ≤ 1 μs, 300 pulses/s	I _{FSM}	1	A
Power dissipation		P _{diss}	20	mW
OUTPUT				
Supply voltage		V _{CC}	- 0.5 to + 15	V
Output voltage		V _O	- 0.5 to + 15	V
Average output current		I _O	25	mA
Power dissipation		P _{diss}	100	mW
COUPLER				
Storage temperature range		T _{stg}	- 55 to + 125	°C
Ambient temperature range		T _{amb}	- 40 to + 85	°C
Lead soldering temperature	t = 10 s	T _s	260	°C
Isolation test voltage	t = 1 s	V _{ISO}	5300	V _{RMS}
Pollution degree			2	
Creepage distance and clearance	Standard lead bending		7	mm
	Option 6, 7, 9		8	mm
Comparative tracking index per DIN IEC 112/VDE 0303, part 1		CTI	175	
Isolation resistance	V _{IO} = 500 V, T _{amb} = 25 °C	R _{IO}	10 ¹²	Ω
	V _{IO} = 500 V, T _{amb} = 100 °C	R _{IO}	10 ¹¹	Ω

Note

- Stresses in excess of the absolute maximum ratings can cause permanent damage to the device. Functional operation of the device is not implied at these or any other conditions in excess of those given in the operational sections of this document. Exposure to absolute maximum ratings for extended periods of the time can adversely affect reliability.

ELECTRICAL CHARACTERISTICS (T _{amb} = 25 °C, unless otherwise specified)						
PARAMETER	TEST CONDITION	SYMBOL	MIN.	TYP.	MAX.	UNIT
INPUT (1)						
Forward voltage	I _F = 5 mA	V _F		1.6	1.75	V
		V _F			1.8	V
Input current hysteresis	V _{CC} = 5 V, I _{HYS} = I _{Fon} - I _{Foff}			01		mA
Reverse current	V _R = 3 V	I _R		0.5	10	μA
Capacitance	V _R = 0 V, f = 1MHz	C _O		60		pF
Thermal resistance		R _{thja}		700		K/W
OUTPUT (1)						
Logic low output voltage	I _{OL} = 6.4 mA	V _{OL}			0.5	V
Logic high output voltage	I _{OH} = - 2.6 mA, V _{OH} = V _{CC} - 1.8 V (2)	V _{OH}	2.4	(2)		V
Output leakage current (V _{OUT} > V _{CC})	V _O = 5.5 V, V _{CC} = 4.5 V, I _F = 5 mA	I _{OHH}		0.5	100	μA
	V _O = 15 V, V _{CC} = 4.5 V, I _F = 5 mA	I _{OHH}		1	500	μA
Logic low supply current	V _{CC} = 5.5 V, I _F = 0 A	I _{CCL}		3.7	6	mA
	V _{CC} = 15 V, I _F = 0 A	I _{CCL}		4.1	6.5	mA
Logic high supply current	V _{CC} = 5.5 V, I _F = 5 mA	I _{CCH}		3.4	4	mA
	V _{CC} = 15 V, I _F = 5 mA	I _{CCH}		3.7	5	mA
Logic low short circuit output current	V _O = V _{CC} = 5.5 V, I _F = 0 A	I _{OSL}	25			mA
	V _O = V _{CC} = 15 V, I _F = 0 A	I _{OSL}	40			mA



ELECTRICAL CHARACTERISTICS ($T_{amb} = 25\text{ }^{\circ}\text{C}$, unless otherwise specified)						
PARAMETER	TEST CONDITION	SYMBOL	MIN.	TYP.	MAX.	UNIT
OUTPUT						
Logic high short circuit output current	$V_{CC} = 5.5\text{ V}$, $V_O = 0\text{ V}$, $I_F = 5\text{ mA}$	I_{OSH}			- 10	mA
	$V_{CC} = 15\text{ V}$, $V_O = 0\text{ V}$, $I_F = 5\text{ mA}$	I_{OSH}			- 25	mA
Thermal resistance				300		K/W
COUPLER						
Capacitance (input to output)	$f = 1\text{ MHz}$, pins 1 to 4 and 5 to 8 shorted together	C_{IO}		0.6		pF

Notes

- Minimum and maximum values are testing requirements. Typical values are characteristics of the device and are the result of engineering evaluation. Typical values are for information only and are not part of the testing requirements.
- $0\text{ }^{\circ}\text{C} \leq T_{amb} \leq 85\text{ }^{\circ}\text{C}$; $4.5\text{ V} \leq V_{CC} \leq 15\text{ V}$; $1.6\text{ mA} \leq I_{Fon} \leq 5\text{ mA}$; $2 \leq V_{EH} \leq 15\text{ V}$; $0 \leq V_{EL} \leq 0.8\text{ V}$; $0\text{ mA} \leq I_{Foff} \leq 0.1\text{ mA}$. Typical values: $T_{amb} = 25\text{ }^{\circ}\text{C}$; $V_{CC} = 5\text{ V}$; $I_{Fon} = 3\text{ mA}$ unless otherwise specified.
- Output short circuit time $\leq 10\text{ ms}$.

SWITCHING CHARACTERISTICS						
PARAMETER	TEST CONDITION	SYMBOL	MIN.	TYP.	MAX.	UNIT
Propagation delay time to logic low output level	without peaking capacitor	t_{PHL}		120		ns
	with peaking capacitor	t_{PHL}		115	300	ns
	without peaking capacitor	t_{PLH}		125		ns
	with peaking capacitor	t_{PLH}		90	300	ns
Output rise time	10 % to 90 %	t_r		40		ns
Output fall time	90 % to 10 %	t_f		10		ns

Note

- $0\text{ }^{\circ}\text{C} \leq T_{amb} \leq 85\text{ }^{\circ}\text{C}$; $4.5\text{ V} \leq V_{CC} \leq 15\text{ V}$; $1.6\text{ mA} \leq I_{Fon} \leq 5\text{ mA}$; $0\text{ mA} \leq I_{Foff} \leq 0.1\text{ mA}$. Typical values: $T_{amb} = 25\text{ }^{\circ}\text{C}$; $V_{CC} = 5\text{ V}$; $I_{Fon} = 3\text{ mA}$ unless otherwise specified.

RECOMMENDED OPERATING CONDITIONS						
PARAMETER	TEST CONDITION	SYMBOL	MIN.	TYP.	MAX.	UNIT
Supply voltage		V_{CC}	4.5		15	V
Forward input current		I_{Fon}	1.6 ⁽¹⁾		5	mA
		I_{Foff}			0.1	mA
Operating temperature		T_A	0		85	$^{\circ}\text{C}$

Notes

- A 0.1 μF bypass capacitor connected between pins 5 and 8 must be used.
- ⁽¹⁾ We recommend using a 2.2 mA to permit at least 20 % CTR degradation guard band.

COMMON MODE TRANSIENT IMMUNITY							
PARAMETER	TEST CONDITION	PART	SYMBOL	MIN.	TYP.	MAX.	UNIT
Logic high common mode transient immunity ⁽¹⁾	$ V_{CM} = 50\text{ V}$, $I_F = 1.6\text{ mA}$	SFH6731	$ CM_H $	1000			V/ μs
	$ V_{CM} = 300\text{ V}$, $I_F = 1.6\text{ mA}$	SFH6732	$ CM_H $	5000			V/ μs
Logic low common mode transient immunity ⁽¹⁾	$ V_{CM} = 50\text{ V}$, $I_F = 0\text{ mA}$	SFH6731	$ CM_L $	1000			V/ μs
	$ V_{CM} = 1000\text{ V}$, $I_F = 0\text{ mA}$	SFH6732	$ CM_L $	10 000			V/ μs

Notes

- $T_{amb} = 25\text{ }^{\circ}\text{C}$, $V_{CC} = 5\text{ V}$ ⁽¹⁾
- ⁽¹⁾ CMH is the maximum slew rate of a common mode voltage VCM at which the output voltage remains at logic high level ($V_O > 2\text{ V}$). CML is the maximum slew rate of a common mode voltage VCM at which the output voltage remains at logic low level ($V_O < 0.8\text{ V}$).

SAFETY AND INSULATION RATINGS						
PARAMETER	TEST CONDITION	SYMBOL	MIN.	TYP.	MAX.	UNIT
Climatic classification (according to IEC 68 part 1)				55/100/21		
Comparative tracking index		CTI	175		399	
V_{IOTM}			8000			V
V_{IORM}			890			V
P_{SO}					500	mW
I_{SI}					300	mA
T_{SI}					175	°C
Creepage distance	Standard DIP-8		7			mm
Clearance distance	Standard DIP-8		7			mm
Creepage distance	400 mil DIP-8		8			mm
Clearance distance	400 mil DIP-8		8			mm

Note

- As per DIN EN 60747-5-2 (VDE 0884), § 7.4.3.8.1, this optocoupler is suitable for “safe electrical insulation” only within the safety ratings. Compliance with the safety ratings shall be ensured by means of protective circuits.

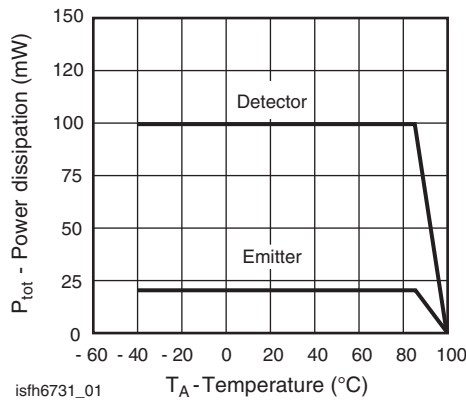
TYPICAL CHARACTERISTICS ($T_{amb} = 25\text{ °C}$, unless otherwise specified)


Fig. 1 - Permissible Total Power Dissipation vs. Temperature

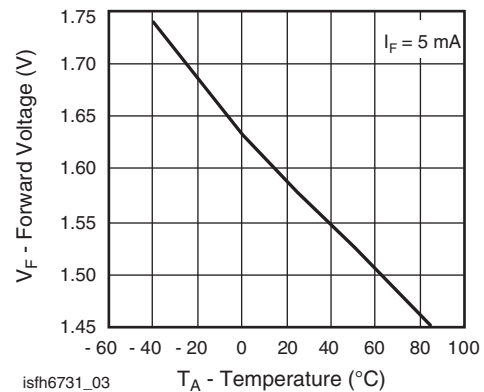


Fig. 3 - Typical Forward Input Voltage vs. Temperature

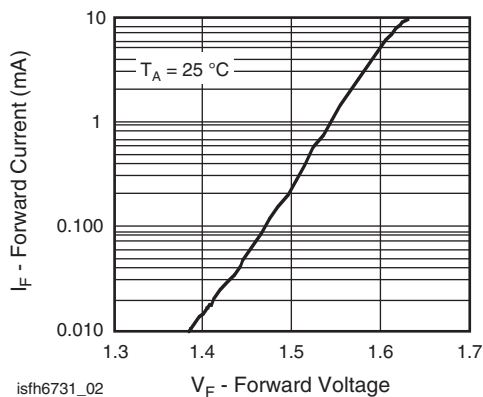


Fig. 2 - Typical Input Diode Forward Current vs. Forward Voltage

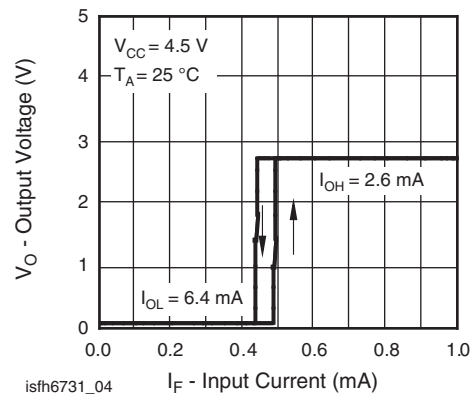


Fig. 4 - Typical Output Voltage vs. Forward Input Current

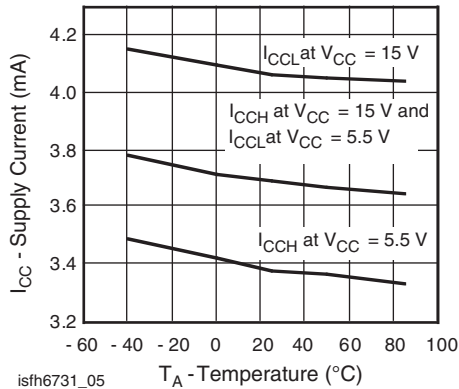


Fig. 5 - Typical Supply Current vs. Temperature

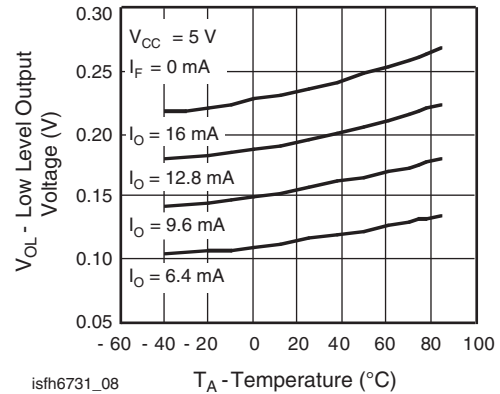


Fig. 8 - Typical Low Level Output Voltage vs. Temperature

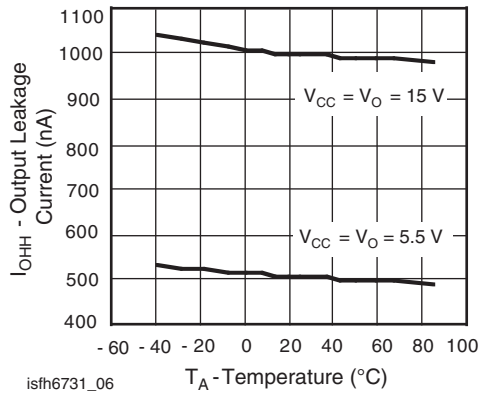


Fig. 6 - Typical Output Leakage Current vs. Temperature

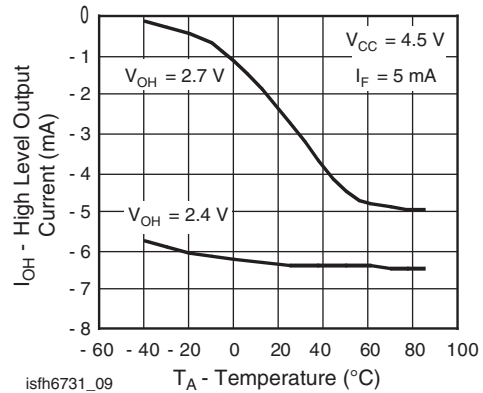


Fig. 9 - Typical High Level Output Current vs. Temperature

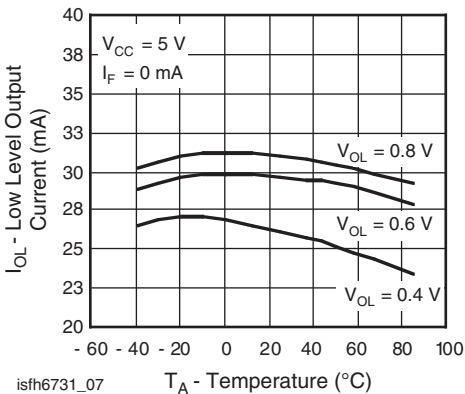


Fig. 7 - Typical Low Level Output Current vs. Temperature

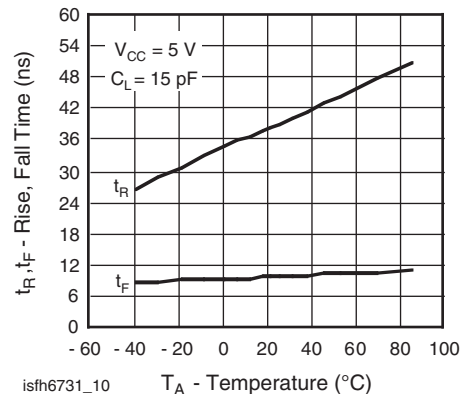


Fig. 10 - Rise and Fall Time vs. Ambient Temperature

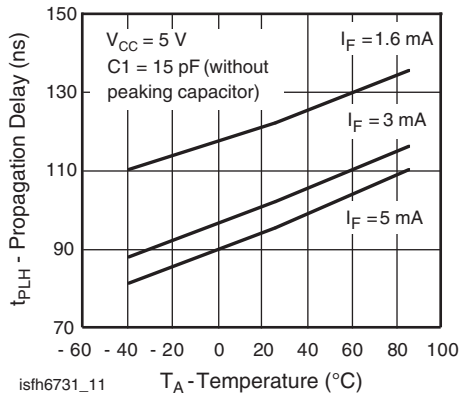


Fig. 11 - Typical Propagation Delays to Logic High vs. Temperature

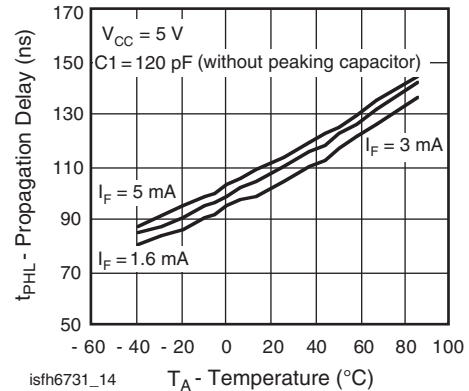


Fig. 14 - Typical Propagation Delays to Logic Low vs. Temperature

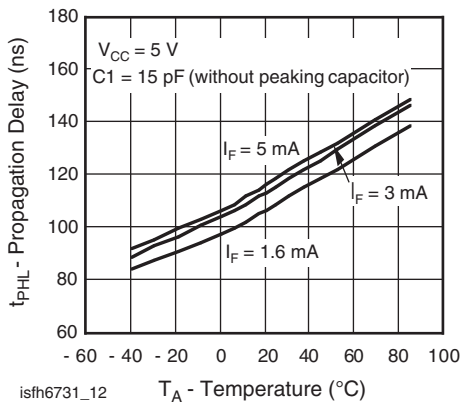


Fig. 12 - Typical Propagation Delays to Logic Low vs. Temperature

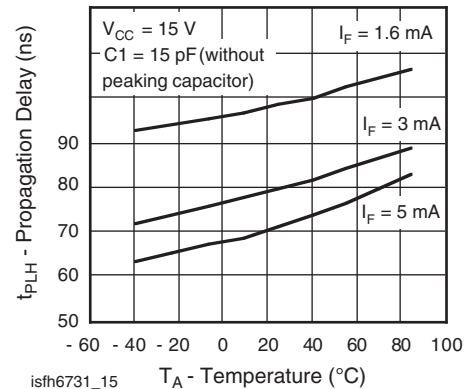


Fig. 15 - Typical Propagation Delays to Logic High vs. Temperature

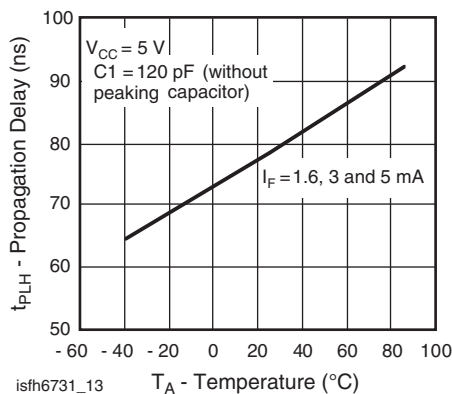


Fig. 13 - Typical Propagation Delays to Logic High vs. Temperature

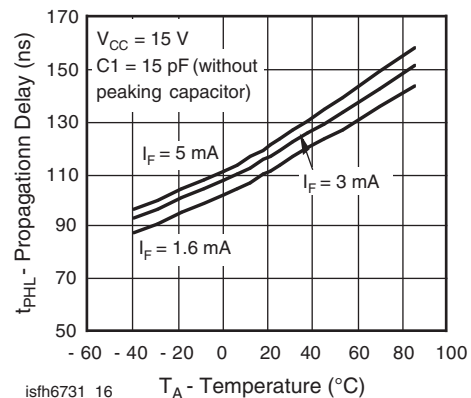


Fig. 16 - Typical Propagation Delays to Logic Low vs. Temperature

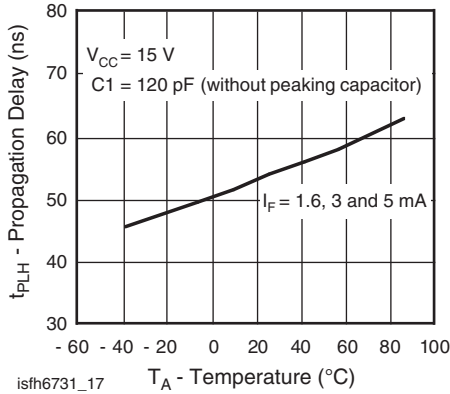


Fig. 17 - Typical Propagation Delays to Logic High vs. Temperature

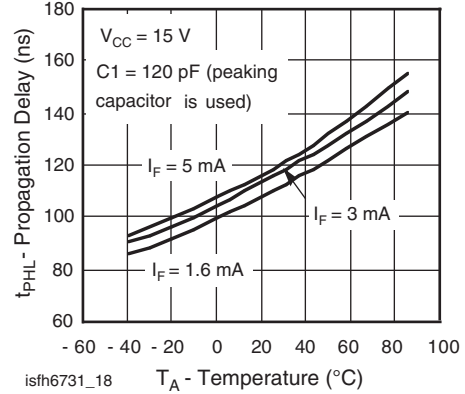


Fig. 18 - Typical Propagation Delays to Logic Low vs. Temperature

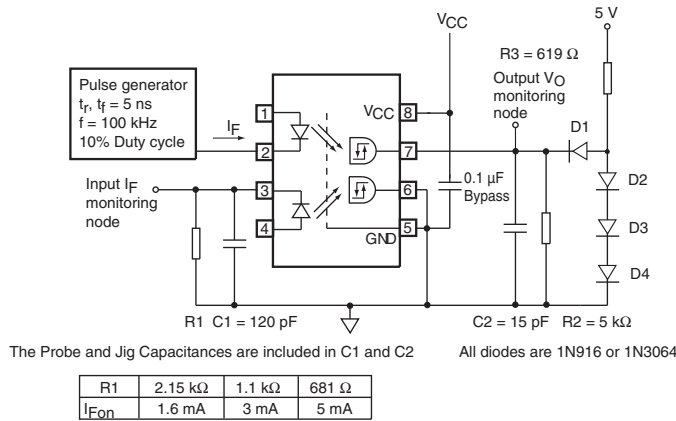


Fig. 19 - Test Circuit for t_{PLH}

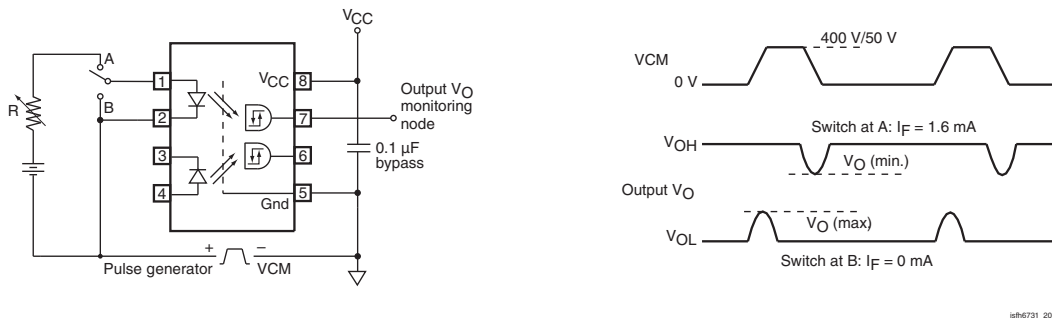
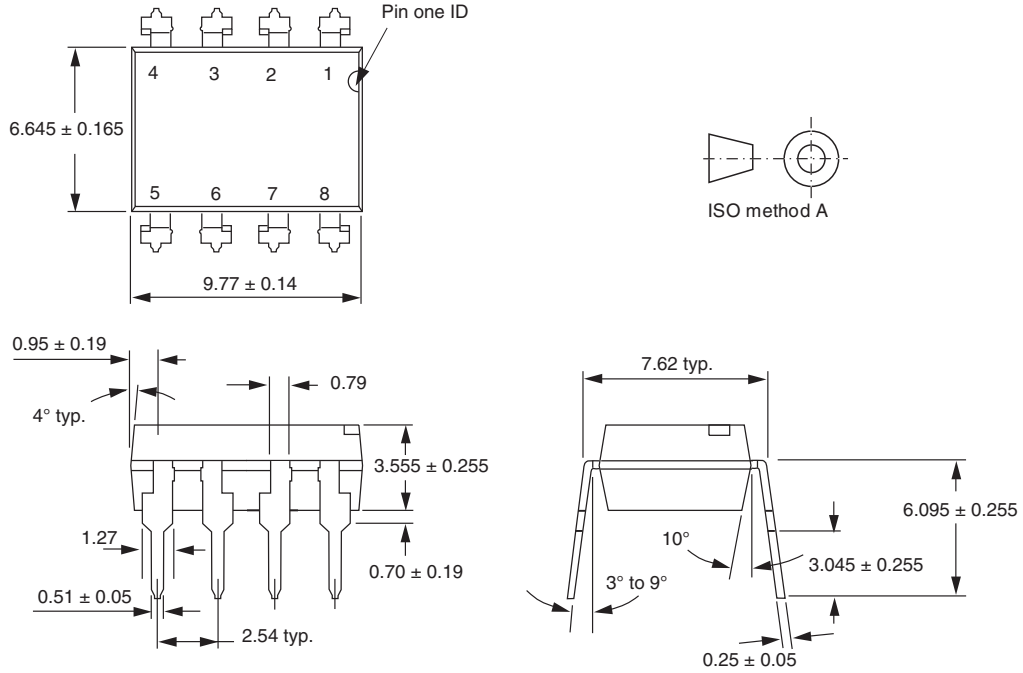


Fig. 20 - Test Circuit for Common Mode Transient Immunity and Typical Waveforms

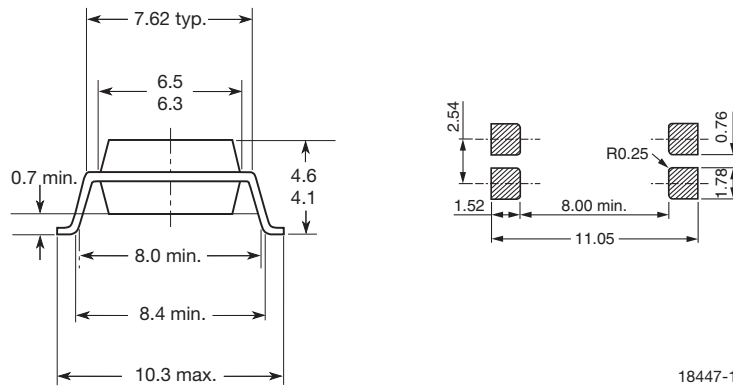


PACKAGE DIMENSIONS in millimeters



1178006

Option 7



18447-1

PACKAGE MARKING (example)



Notes

- The VDE logo is only marked on option 1 parts.
- Tape and reel suffix (T) is not part of the package marking.



Disclaimer

ALL PRODUCT, PRODUCT SPECIFICATIONS AND DATA ARE SUBJECT TO CHANGE WITHOUT NOTICE TO IMPROVE RELIABILITY, FUNCTION OR DESIGN OR OTHERWISE.

Vishay Intertechnology, Inc., its affiliates, agents, and employees, and all persons acting on its or their behalf (collectively, "Vishay"), disclaim any and all liability for any errors, inaccuracies or incompleteness contained in any datasheet or in any other disclosure relating to any product.

Vishay makes no warranty, representation or guarantee regarding the suitability of the products for any particular purpose or the continuing production of any product. To the maximum extent permitted by applicable law, Vishay disclaims (i) any and all liability arising out of the application or use of any product, (ii) any and all liability, including without limitation special, consequential or incidental damages, and (iii) any and all implied warranties, including warranties of fitness for particular purpose, non-infringement and merchantability.

Statements regarding the suitability of products for certain types of applications are based on Vishay's knowledge of typical requirements that are often placed on Vishay products in generic applications. Such statements are not binding statements about the suitability of products for a particular application. It is the customer's responsibility to validate that a particular product with the properties described in the product specification is suitable for use in a particular application. Parameters provided in datasheets and/or specifications may vary in different applications and performance may vary over time. All operating parameters, including typical parameters, must be validated for each customer application by the customer's technical experts. Product specifications do not expand or otherwise modify Vishay's terms and conditions of purchase, including but not limited to the warranty expressed therein.

Except as expressly indicated in writing, Vishay products are not designed for use in medical, life-saving, or life-sustaining applications or for any other application in which the failure of the Vishay product could result in personal injury or death. Customers using or selling Vishay products not expressly indicated for use in such applications do so at their own risk. Please contact authorized Vishay personnel to obtain written terms and conditions regarding products designed for such applications.

No license, express or implied, by estoppel or otherwise, to any intellectual property rights is granted by this document or by any conduct of Vishay. Product names and markings noted herein may be trademarks of their respective owners.

Material Category Policy

Vishay Intertechnology, Inc. hereby certifies that all its products that are identified as RoHS-Compliant fulfill the definitions and restrictions defined under Directive 2011/65/EU of The European Parliament and of the Council of June 8, 2011 on the restriction of the use of certain hazardous substances in electrical and electronic equipment (EEE) - recast, unless otherwise specified as non-compliant.

Please note that some Vishay documentation may still make reference to RoHS Directive 2002/95/EC. We confirm that all the products identified as being compliant to Directive 2002/95/EC conform to Directive 2011/65/EU.

Vishay Intertechnology, Inc. hereby certifies that all its products that are identified as Halogen-Free follow Halogen-Free requirements as per JEDEC JS709A standards. Please note that some Vishay documentation may still make reference to the IEC 61249-2-21 definition. We confirm that all the products identified as being compliant to IEC 61249-2-21 conform to JEDEC JS709A standards.



Disclaimer

ALL PRODUCT, PRODUCT SPECIFICATIONS AND DATA ARE SUBJECT TO CHANGE WITHOUT NOTICE TO IMPROVE RELIABILITY, FUNCTION OR DESIGN OR OTHERWISE.

Vishay Intertechnology, Inc., its affiliates, agents, and employees, and all persons acting on its or their behalf (collectively, "Vishay"), disclaim any and all liability for any errors, inaccuracies or incompleteness contained in any datasheet or in any other disclosure relating to any product.

Vishay makes no warranty, representation or guarantee regarding the suitability of the products for any particular purpose or the continuing production of any product. To the maximum extent permitted by applicable law, Vishay disclaims (i) any and all liability arising out of the application or use of any product, (ii) any and all liability, including without limitation special, consequential or incidental damages, and (iii) any and all implied warranties, including warranties of fitness for particular purpose, non-infringement and merchantability.

Statements regarding the suitability of products for certain types of applications are based on Vishay's knowledge of typical requirements that are often placed on Vishay products in generic applications. Such statements are not binding statements about the suitability of products for a particular application. It is the customer's responsibility to validate that a particular product with the properties described in the product specification is suitable for use in a particular application. Parameters provided in datasheets and/or specifications may vary in different applications and performance may vary over time. All operating parameters, including typical parameters, must be validated for each customer application by the customer's technical experts. Product specifications do not expand or otherwise modify Vishay's terms and conditions of purchase, including but not limited to the warranty expressed therein.

Except as expressly indicated in writing, Vishay products are not designed for use in medical, life-saving, or life-sustaining applications or for any other application in which the failure of the Vishay product could result in personal injury or death. Customers using or selling Vishay products not expressly indicated for use in such applications do so at their own risk. Please contact authorized Vishay personnel to obtain written terms and conditions regarding products designed for such applications.

No license, express or implied, by estoppel or otherwise, to any intellectual property rights is granted by this document or by any conduct of Vishay. Product names and markings noted herein may be trademarks of their respective owners.

Material Category Policy

Vishay Intertechnology, Inc. hereby certifies that all its products that are identified as RoHS-Compliant fulfill the definitions and restrictions defined under Directive 2011/65/EU of The European Parliament and of the Council of June 8, 2011 on the restriction of the use of certain hazardous substances in electrical and electronic equipment (EEE) - recast, unless otherwise specified as non-compliant.

Please note that some Vishay documentation may still make reference to RoHS Directive 2002/95/EC. We confirm that all the products identified as being compliant to Directive 2002/95/EC conform to Directive 2011/65/EU.

Vishay Intertechnology, Inc. hereby certifies that all its products that are identified as Halogen-Free follow Halogen-Free requirements as per JEDEC JS709A standards. Please note that some Vishay documentation may still make reference to the IEC 61249-2-21 definition. We confirm that all the products identified as being compliant to IEC 61249-2-21 conform to JEDEC JS709A standards.