



Chipsmall Limited consists of a professional team with an average of over 10 year of expertise in the distribution of electronic components. Based in Hongkong, we have already established firm and mutual-benefit business relationships with customers from,Europe,America and south Asia,supplying obsolete and hard-to-find components to meet their specific needs.

With the principle of “Quality Parts,Customers Priority,Honest Operation,and Considerate Service”,our business mainly focus on the distribution of electronic components. Line cards we deal with include Microchip,ALPS,ROHM,Xilinx,Pulse,ON,Everlight and Freescale. Main products comprise IC,Modules,Potentiometer,IC Socket,Relay,Connector.Our parts cover such applications as commercial,industrial, and automotives areas.

We are looking forward to setting up business relationship with you and hope to provide you with the best service and solution. Let us make a better world for our industry!



## Contact us

Tel: +86-755-8981 8866 Fax: +86-755-8427 6832

Email & Skype: info@chipsmall.com Web: www.chipsmall.com

Address: A1208, Overseas Decoration Building, #122 Zhenhua RD., Futian, Shenzhen, China



## 10A, 50V - 600V Surface Mount Super Fast Rectifiers

### FEATURES

- Low forward voltage drop
- Ideal for automated placement
- High current capability
- High surge current capability
- Compliant to RoHS Directive 2011/65/EU and in accordance to WEEE 2002/96/EC
- Halogen-free according to IEC 61249-2-21 definition

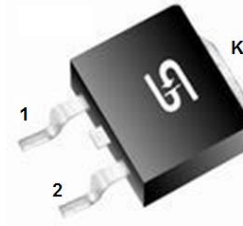

### TO-263AB (D<sup>2</sup>PAK)

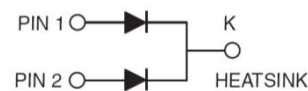

### MECHANICAL DATA

**Case:** TO-263AB (D<sup>2</sup>PAK)

Molding compound, UL flammability classification rating 94V-0

Moisture sensitivity level: level 1, per J-STD-020

Part no. with suffix "H" means AEC-Q101 qualified

Packing code with suffix "G" means green compound (halogen-free)

**Terminal:** Matte tin plated leads, solderable per JESD22-B102

Meet JESD 201 class 2 whisker test

**Polarity:** As marked

**Weight:** 1.37 g (approximately)

MAXIMUM RATINGS AND ELECTRICAL CHARACTERISTICS (T <sub>A</sub> =25°C unless otherwise noted)										
PARAMETER	SYMBOL	SFS	SFS	SFS	SFS	SFS	SFS	SFS	SFS	UNIT
		1001	1002	1003	1004	1005	1006	1007	1008	
		G	G	G	G	G	G	G	G	
Maximum repetitive peak reverse voltage	V <sub>RRM</sub>	50	100	150	200	300	400	500	600	V
Maximum RMS voltage	V <sub>RMS</sub>	35	70	105	140	210	280	350	420	V
Maximum DC blocking voltage	V <sub>DC</sub>	50	100	150	200	300	400	500	600	V
Maximum average forward rectified current	I <sub>F(AV)</sub>	10								A
Peak forward surge current, 8.3 ms single half sine-wave superimposed on rated load	I <sub>FSM</sub>	125								A
Maximum instantaneous forward voltage (Note 1) I <sub>F</sub> = 5 A	V <sub>F</sub>	0.975			1.3		1.7			V
Maximum reverse current @ rated V <sub>R</sub> T <sub>J</sub> =25°C T <sub>J</sub> =125°C	I <sub>R</sub>	1 200								μA
Maximum reverse recovery time (Note 2)	t <sub>rr</sub>	35								ns
Typical junction capacitance (Note 3)	C <sub>J</sub>	70				50				pF
Typical thermal resistance	R <sub>θJC</sub>	2								°C/W
Operating junction temperature range	T <sub>J</sub>	- 55 to +150								°C
Storage temperature range	T <sub>STG</sub>	- 55 to +150								°C

Note 1: Pulse test with PW=300μs, 1% duty cycle

Note 2: Reverse Recovery Test Conditions: I<sub>F</sub>=0.5A, I<sub>R</sub>=1.0A, I<sub>RR</sub>=0.25A

Note 3: Measured at 1 MHz and Applied Reverse Voltage of 4.0V D.C.

**ORDERING INFORMATION**

PART NO.	PART NO. SUFFIX	PACKING CODE	PACKING CODE SUFFIX (*)	PACKAGE	PACKING
SFS100xG (Note 1)	H	RN	G	D <sup>2</sup> PAK	800 / 13" Paper reel
		MN			800 / 13" Plastic reel

Note 1: "x" defines voltage from 50V (SFS1001G) to 600V (SFS1008G)

\*: Optional available

**EXAMPLE**

PREFERRED P/N	PART NO.	PART NO. SUFFIX	PACKING CODE	PACKING CODE SUFFIX	DESCRIPTION
SFS1008GHRNG	SFS1008G	H	RN	G	AEC-Q101 qualified Green compound

**RATINGS AND CHARACTERISTICS CURVES**

(T<sub>A</sub>=25°C unless otherwise noted)

FIG.1 FORWARD CURRENT DERATING CURVE

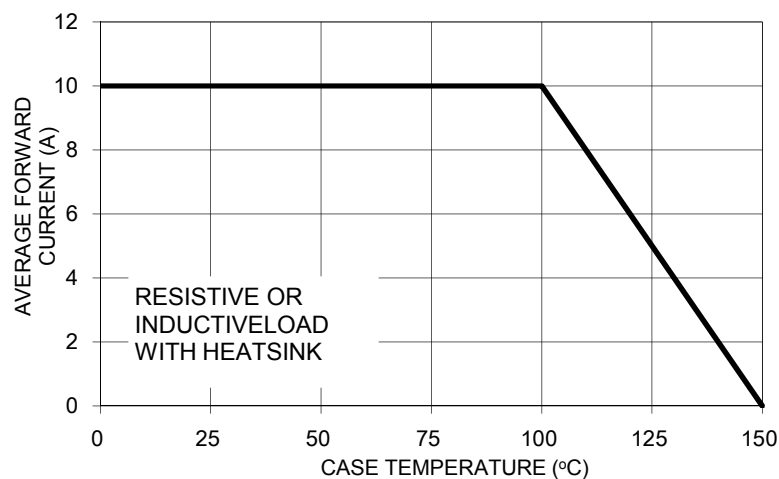

FIG. 2 TYPICAL REVERSE CHARACTERISTICS

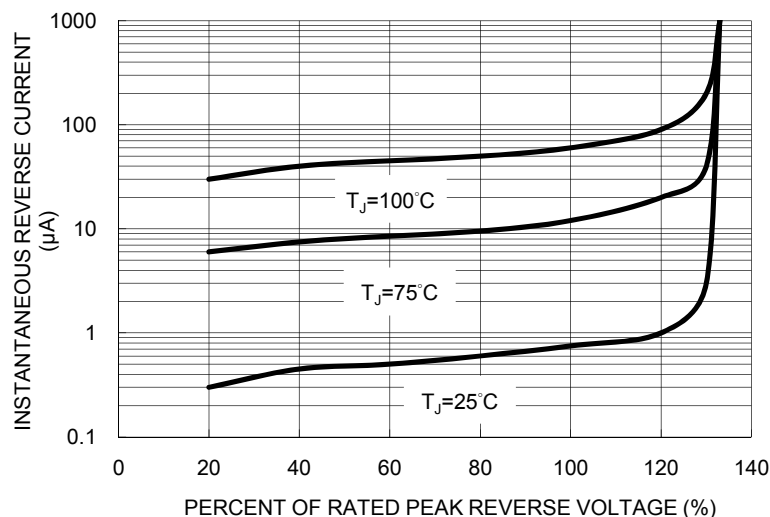

FIG. 3 MAXIMUM NON-REPETITIVE FORWARD SURGE CURRENT

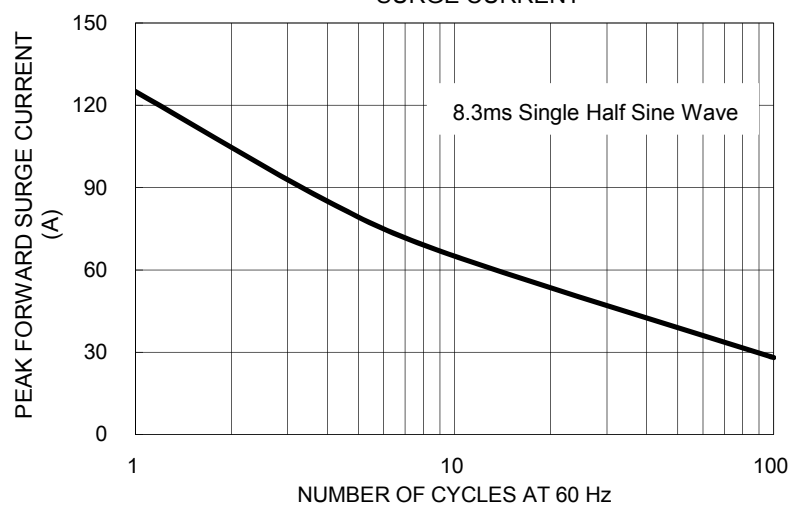
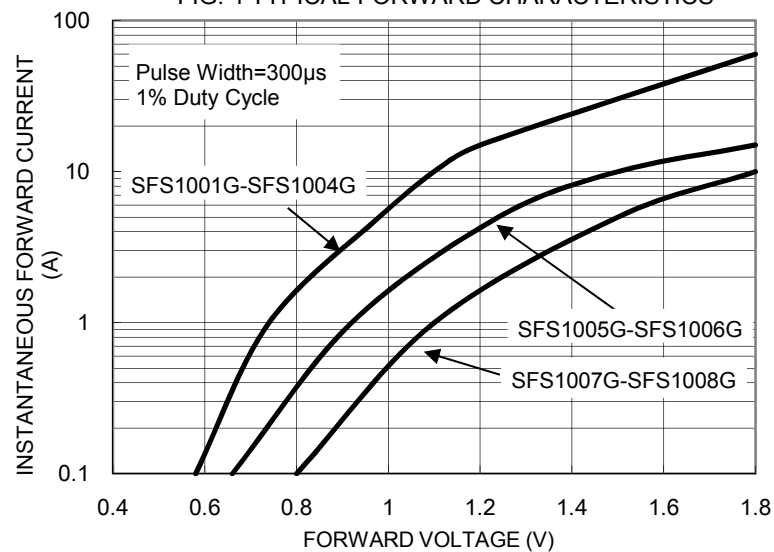
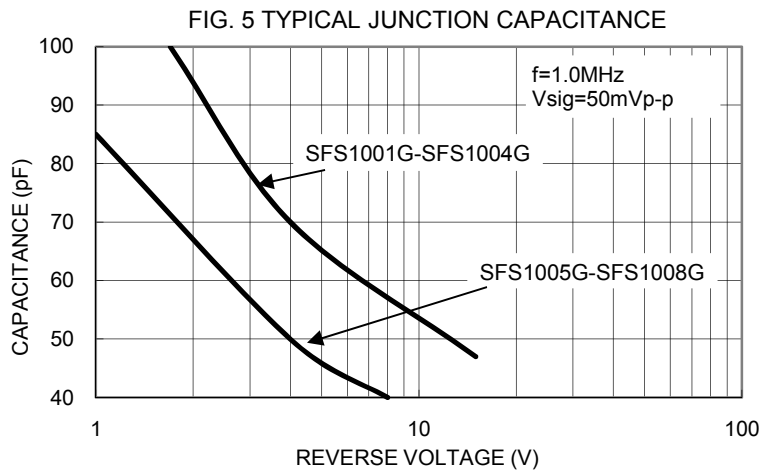
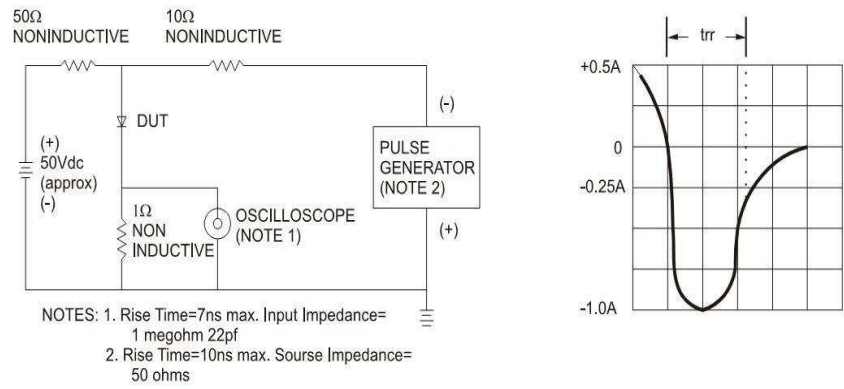

FIG. 4 TYPICAL FORWARD CHARACTERISTICS

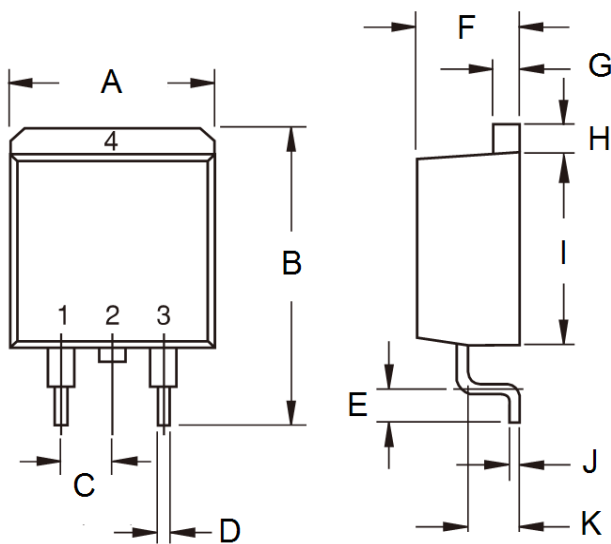



**FIG.6- REVERSE RECOVERY TIME CHARACTERISTIC AND TEST CIRCUIT DIAGRAM**



**PACKAGE OUTLINE DIMENSIONS**  
**TO-263AB (D<sup>2</sup>PAK)**



DIM.	Unit (mm)		Unit (inch)	
	Min	Max	Min	Max
A	-	10.5	-	0.413
B	14.60	15.88	0.575	0.625
C	2.41	2.67	0.095	0.105
D	0.68	0.94	0.027	0.037
E	2.29	2.79	0.090	0.110
F	4.44	4.70	0.175	0.185
G	1.14	1.40	0.045	0.055
H	1.14	1.40	0.045	0.055
I	8.25	9.25	0.325	0.364
J	0.36	0.53	0.014	0.021
K	2.03	2.79	0.080	0.110

**SUGGESTED PAD LAYOUT**

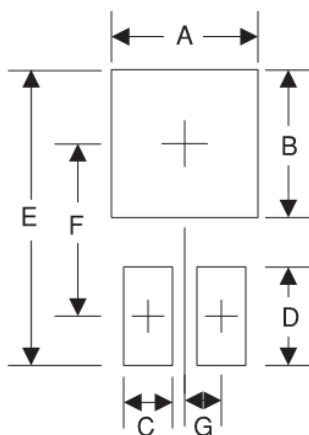

Symbol	Unit (mm)	Unit (inch)
A	10.8	0.425
B	8.3	0.327
C	1.1	0.043
D	3.5	0.138
E	16.9	0.665
F	9.5	0.374
G	2.5	0.098

**MARKING DIAGRAM**



P/N = Specific Device Code  
G = Green Compound  
YWW = Date Code  
F = Factory Code

### **Notice**

Specifications of the products displayed herein are subject to change without notice. TSC or anyone on its behalf, assumes no responsibility or liability for any errors or inaccuracies.

Information contained herein is intended to provide a product description only. No license, express or implied, to any intellectual property rights is granted by this document. Except as provided in TSC's terms and conditions of sale for such products, TSC assumes no liability whatsoever, and disclaims any express or implied warranty, relating to sale and/or use of TSC products including liability or warranties relating to fitness for a particular purpose, merchantability, or infringement of any patent, copyright, or other intellectual property right.

The products shown herein are not designed for use in medical, life-saving, or life-sustaining applications. Customers using or selling these products for use in such applications do so at their own risk and agree to fully indemnify TSC for any damages resulting from such improper use or sale.