



Chipsmall Limited consists of a professional team with an average of over 10 year of expertise in the distribution of electronic components. Based in Hongkong, we have already established firm and mutual-benefit business relationships with customers from,Europe,America and south Asia,supplying obsolete and hard-to-find components to meet their specific needs.

With the principle of “Quality Parts,Customers Priority,Honest Operation,and Considerate Service”,our business mainly focus on the distribution of electronic components. Line cards we deal with include Microchip,ALPS,ROHM,Xilinx,Pulse,ON,Everlight and Freescale. Main products comprise IC,Modules,Potentiometer,IC Socket,Relay,Connector.Our parts cover such applications as commercial,industrial, and automotives areas.

We are looking forward to setting up business relationship with you and hope to provide you with the best service and solution. Let us make a better world for our industry!



Contact us

Tel: +86-755-8981 8866 Fax: +86-755-8427 6832

Email & Skype: info@chipsmall.com Web: www.chipsmall.com

Address: A1208, Overseas Decoration Building, #122 Zhenhua RD., Futian, Shenzhen, China



REV	DESCRIPTION	DATE	APP
00	NEW DRAWING	10/10/12	

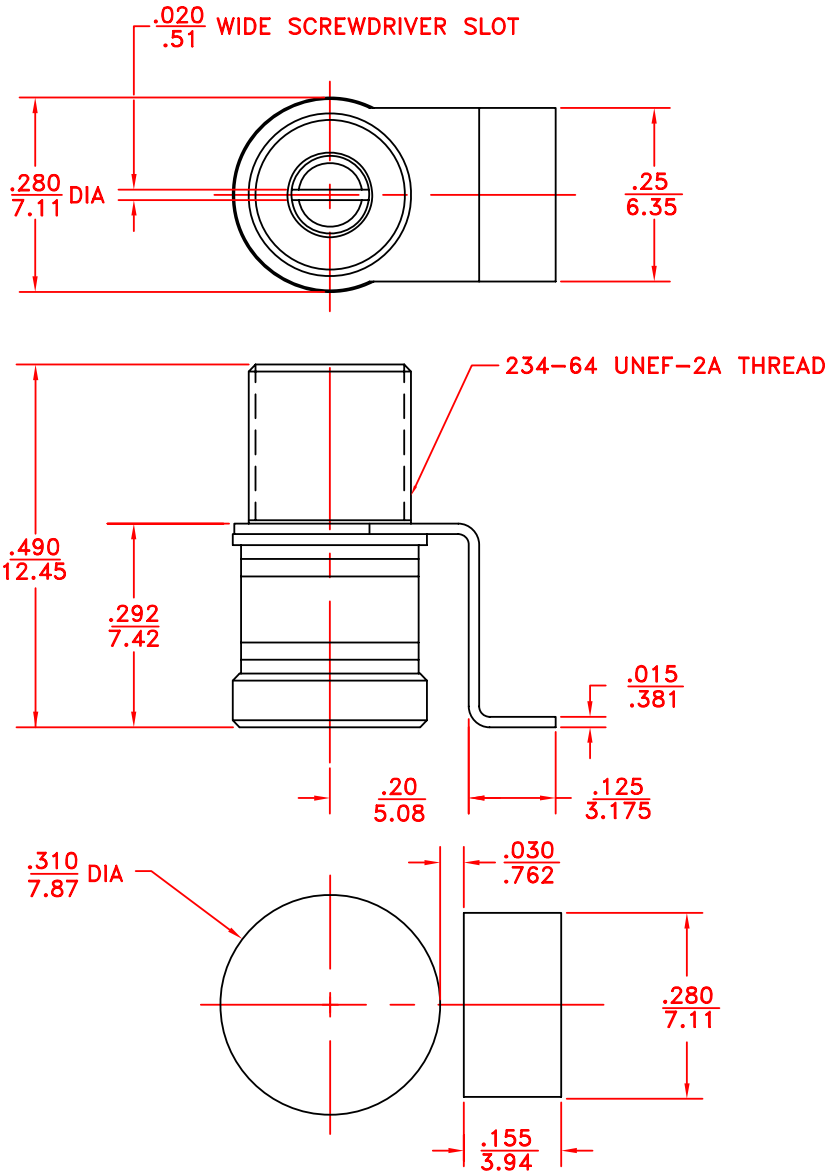

NOTES:

1. $C_{max} \geq 10$ pF
2. C_{min} below 1.0pF
3. Working voltage 1000 VDC
4. Withstanding voltage 2000 VDC
5. $Q @ C_{max}$ and 100 MHZ over 2000
6. Operating temperature -65° C to $+125^{\circ}$ C
7. Torque .5 to 5.0 oz-in
8. Rotational life 10,000 turns
9. Dimensions: (in/mm)
10. Construction: nonmagnetic

SUGGESTED MOUNTING PAD LAYOUT

TOLERANCES: (EXCEPT AS NOTED)				SPRAGUE GOODMAN ELECTRONICS INC. 1700 SHAMES DRIVE WESTBURY, NY 11590			
DECIMAL: ± 0.002 in ± 0.051 mm		MATERIAL:		SCALE: 4:1		DRAWN BY: R. LEVIN	
FRACTIONAL: 1/64		TITLE: OUTLINE DWG SGNMA3T10009				APPROVED: D. DITLYA	
ANGULAR: 1°		DATE: 10/10/12		DRAWING NUMBER SGNMA3T10009		USED FOR: REV. 00	