



Chipsmall Limited consists of a professional team with an average of over 10 year of expertise in the distribution of electronic components. Based in Hongkong, we have already established firm and mutual-benefit business relationships with customers from,Europe,America and south Asia,supplying obsolete and hard-to-find components to meet their specific needs.

With the principle of “Quality Parts,Customers Priority,Honest Operation,and Considerate Service”,our business mainly focus on the distribution of electronic components. Line cards we deal with include Microchip,ALPS,ROHM,Xilinx,Pulse,ON,Everlight and Freescale. Main products comprise IC,Modules,Potentiometer,IC Socket,Relay,Connector.Our parts cover such applications as commercial,industrial, and automotives areas.

We are looking forward to setting up business relationship with you and hope to provide you with the best service and solution. Let us make a better world for our industry!



Contact us

Tel: +86-755-8981 8866 Fax: +86-755-8427 6832

Email & Skype: info@chipsmall.com Web: www.chipsmall.com

Address: A1208, Overseas Decoration Building, #122 Zhenhua RD., Futian, Shenzhen, China



REV	DESCRIPTION	DATE	APP
00	NEW DRAWING	08/11/11	

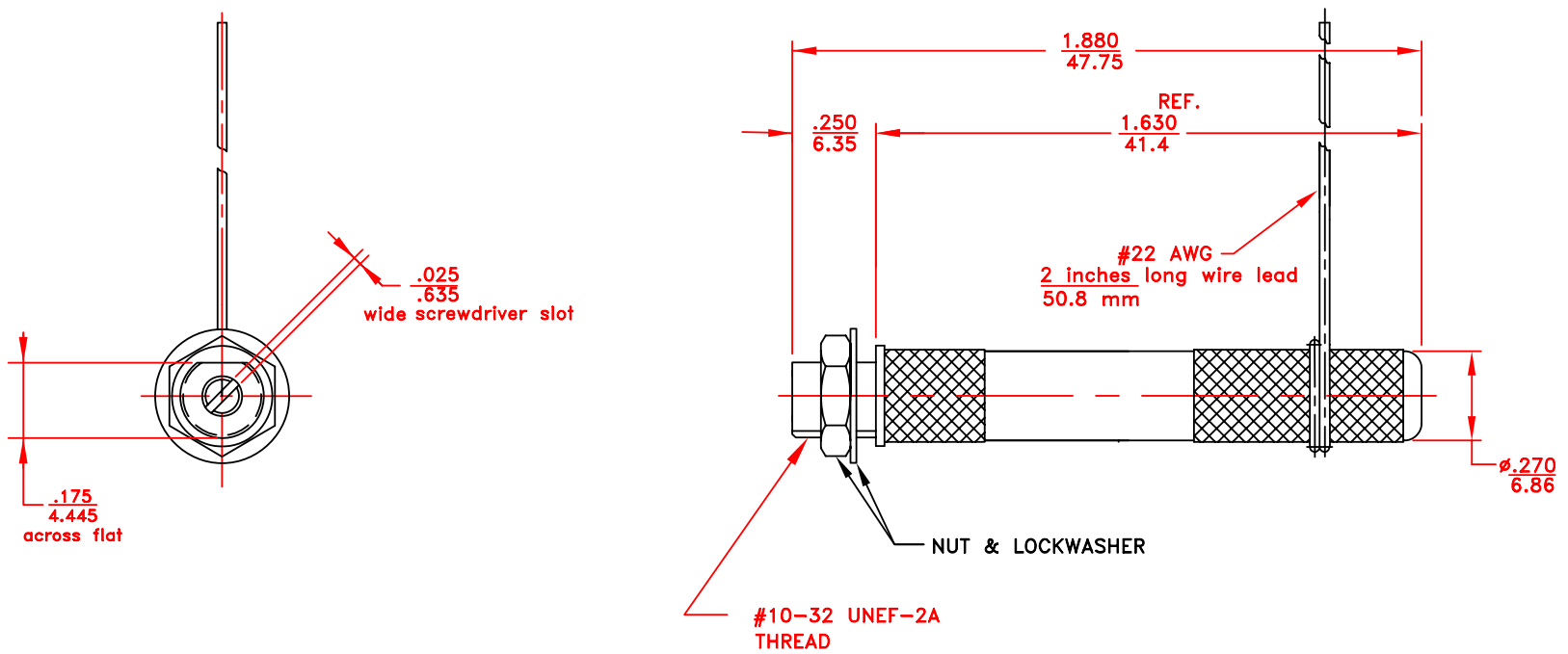

- NOTES:
1. Capacitance: Cmax over 15pF
 2. Capacitance: Cmin less than 1.5 pF
 3. Working voltage: 2 kVDC
 4. Withstanding voltage: 4 kVDC
 5. Torque 1.0 to 5.0 oz-in
 6. Dimension: in/mm
 7. Construction: 40 psi sealed, non-magnetic
 8. Operating temperature : below -55°C to +125°C.
 9. Dimensions: in/mm
 10. Rotational life: 10,000 turns

TOLERANCES: (EXCEPT AS NOTED)		SPRAGUE GOODMAN ELECTRONICS INC. 1700 SHAMES DRIVE WESTBURY, NY 11590	
DECIMAL: ±0.002 in ±0.051 mm	MATERIAL:	SCALE: 2:1	DRAWN BY: R. LEVIN APPROVED: D. DITLYA
FRACTIONAL: 1/64	TITLE: SGNMNC1152		USED FOR:
ANGULAR: 1°	DATE: 08/11/11	DRAWING NUMBER SGNMNC1152	REV. 00