



Chipsmall Limited consists of a professional team with an average of over 10 year of expertise in the distribution of electronic components. Based in Hongkong, we have already established firm and mutual-benefit business relationships with customers from,Europe,America and south Asia,supplying obsolete and hard-to-find components to meet their specific needs.

With the principle of "Quality Parts,Customers Priority,Honest Operation,and Considerate Service",our business mainly focus on the distribution of electronic components. Line cards we deal with include Microchip,ALPS,ROHM,Xilinx,Pulse,ON,Everlight and Freescale. Main products comprise IC,Modules,Potentiometer,IC Socket,Relay,Connector.Our parts cover such applications as commercial,industrial, and automotives areas.

We are looking forward to setting up business relationship with you and hope to provide you with the best service and solution. Let us make a better world for our industry!



## Contact us

Tel: +86-755-8981 8866 Fax: +86-755-8427 6832

Email & Skype: info@chipsmall.com Web: www.chipsmall.com

Address: A1208, Overseas Decoration Building, #122 Zhenhua RD., Futian, Shenzhen, China



# Silicon Protection Circuits

## Surface Mount Surgeor™ Transient Voltage Suppressors

### Surgeor Thyristors For Telecom Protection



Designed to suppress lightning and other transients, Surgeor suppressors are primarily intended for operation on the telephone line “tip and ring” environment in order to protect telecommunications CPE and COE products in conjunction with the Littelfuse 461 series Telecom Nano<sup>20</sup> fuse. These devices provide secondary protection for telecommunication equipment such as telephone, MODEM, line card and other devices subject to damage from transient over voltage events. Surgeors can be an integral part of a Telephone Line Protector Unit, meeting AC Power Cross criteria when used in association with properly selected resistor/ PTC/ fuse combinations such as the Littelfuse 461 series fuse. Littelfuse Surface Mount Surgeors are manufactured using a silicon thyristor technology, offering bidirectional voltage clamping for transients of either polarity from a single chip.

The Surgeor devices described in this data sheet are manufactured with the DO-214AA low profile case style and are second source equivalent parts to industry “SIDAC” types. Surface Mount Surgeor Suppressors are supplied in embossed carrier tape on 330mm (13in) reels.

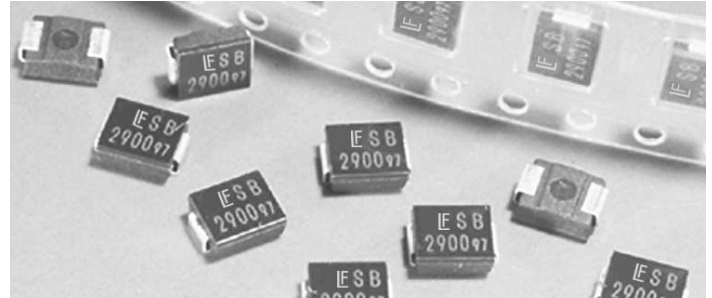

#### Ordering Information

PART NUMBER	V <sub>BD</sub> (MAX) AT <sub>I<sub>BD</sub></sub> =800MA (V)	I <sub>pp</sub> (MAX) 10 x 1000µs Pulse (A)	I <sub>pp</sub> (MAX) 2 x 10µs Pulse (A)
<b>B TYPES</b>			
SGT0640SBT	77	50	320
SGT0720SBT	88	50	320
SGT2300SBT	260	50	200
SGT2900SBT	330	50	200
SGT3100SBT	350	50	200
<b>C TYPES</b>			
SGT0640SCT	77	100	600
SGT0720SCT	88	100	600
SGT1300SCT	160	100	600
SGT1500SCT	180	100	600
SGT2300SCT	260	100	500
SGT2900SCT	330	100	500
SGT3100SCT	350	100	500
SGT3500SCT	400	100	500

NOTE: T Suffix indicates Tape and Reel.

#### Features

- Rated for Telecom Industry Transient Surge Levels:
  - Telcordia (Bellcore) GR-1089
  - ITU CCITT K.20/.21
  - FCC PART 68
  - UL 60950
- Low Profile Package, Compatible with PCMCIA Cards, UL-94V-0 Listed
- Offered in the Most Common V<sub>DRM</sub> Voltage Types
- Low On-State Voltage
- Cross to Common Industry Types
- High Minimum Holding Current

**AGENCY APPROVALS:** Recognized under the components program of Underwriters Laboratories.

**AGENCY FILE NUMBERS:** UL E135010.

#### Applications

- Secondary Protection for:
  - DSL modem
  - Set Top Box
  - Telephone
  - FAX
  - Modem
  - Line Cards
  - SLIC
  - TLPU Modules
- Alarm Systems
- CATV Lines
- Cable Modems

#### Symbol



### Surgeor Thyristors For Telecom Protection

#### Absolute Maximum Ratings

Continuous Reverse Voltage, $V_{DRM}$ .....	.58V to 300V	
Transient Peak Surge Current, $I_{pp}$	B Types	C Types
8 x 20 $\mu$ s	200A	400A
10 x 160 $\mu$ s	150A	200A
10 x 560 $\mu$ s	100A	150A
10 x 1000 $\mu$ s	50A	100A
Critical Rate of Rise of Voltage, $dv/dt$ .....	.2000V/ $\mu$ s	

#### Thermal Information

Thermal Resistance (Typical, Note 1)	$\theta_{JA}$ (°C/W)
J-Bend Package	
C Types .....	85
B Type .....	90
Maximum Storage Temperature Range .....	- 65°C to 150°C
Maximum Junction Temperature (Plastic Package) .....	150°C
Maximum Lead Temperature (Soldering 5s) .....	300°C

#### Operating Conditions

Temperature Range, ( $T_A$ ) .....

CAUTION: Stresses above those listed in "Absolute Maximum Ratings" may cause permanent damage to the device. This is a stress only rating and operation of the device at these or any other conditions above those indicated in the operational sections of this specification is not implied.

#### NOTE:

1.  $\theta_{JA}$  is measured with the component mounted on an evaluation PC board in free air.

#### Electrical Specifications $T_C = 25^\circ\text{C}$ , Unless Otherwise Specified

MODEL NUMBER	$V_{DRM}$ (MAX) V	$I_{DRM}$ (MAX) AT $V_{DRM}$ $\mu$ A	$V_T$ (MAX) AT 2 A V	$V_{BO}$ (MAX) AT $I_{BO} = 800\text{mA}$ (NOTE 2) V	$I_H$ (MIN) mA	$I_{pp}$ (MAX) FOR 10 x 1000 $\mu$ s PULSE (NOTE 3) A	$I_{TSM}$ (NOTE 4) A	$C_O$ (Typ) AT 1MHz / 1 $V_{RMS}, 2V_{DC}$ pF
<b>B TYPES</b>								
SGT0640SBT	58	5	5	77	150	50	25	80
SGT0720SBT	63	5	5	88	150	50	25	80
SGT2300SBT	190	5	5	260	150	50	25	30
SGT2900SBT	250	5	5	330	150	50	25	30
SGT3100SBT	275	5	5	350	150	50	25	30
<b>C TYPES</b>								
SGT0640SCT	58	5	5	77	150	100	65	280
SGT0720SCT	63	5	5	88	150	100	65	280
SGT1300SCT	120	5	5	160	150	100	65	150
SGT1500SCT	140	5	5	190	150	100	65	150
SGT2300SCT	190	5	5	260	150	100	65	100
SGT2900SCT	250	5	5	330	150	100	65	70
SGT3100SCT	275	5	5	350	150	100	65	70
SGT3500SCT	300	5	5	400	150	100	65	55

#### NOTES:

- $dv/dt = 100V/\mu s$ .
- Double exponential current waveform.
- One half cycle, 50 to 60Hz sine, non repetitive.

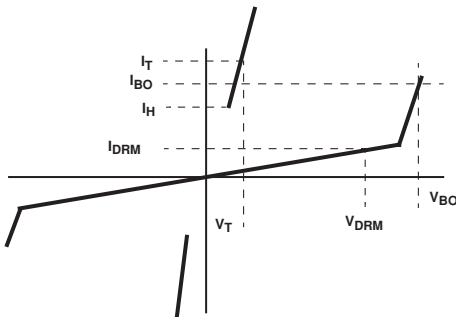
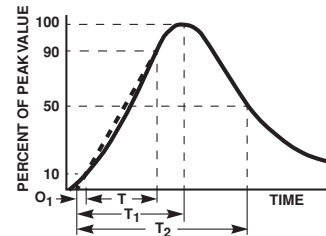

FIGURE 1. V-I CHARACTERISTICS



$O_1$  = Virtual Origin of Wave  
 $T$  = Time From 10% to 90% of Peak  
 $T_1$  = Virtual Front Time =  $1.25 \cdot t$   
 $T_2$  = Virtual Time to Half Value (Impulse Duration)

Example: For an 8/20 $\mu$ s Current Waveform:  
 $8\mu s = T_1$  = Virtual Front Time  
 $20\mu s = T_2$  = Virtual Time to Half Value

FIGURE 2. PEAK PULSE CURRENT TEST WAVEFORM

### Surgeor Thyristors For Telecom Protection

TABLE 1. ELECTRICAL CHARACTERISTICS

MODEL NUMBER	VARIATION OF $V_{BO}$ vs TEMP $T_A = -40^{\circ}C$ TO $85^{\circ}C$ (%) (NOTE 5)	TYPICAL $V_T$ AT PEAK $I_T, T_A = 25^{\circ}C$ VOLTS (V) (NOTE 6)	VARIATION OF $C_O$ vs FREQUENCY (%) (NOTE 7)	MAXIMUM CRITICAL RATE OF RISE OF ON-STATE CURRENT ( $dI/dT$ )(A/ $\mu s$ ) (NOTE 8)	MAXIMUM $I_{PP}$ FOR $2 \times 10 \mu s$ WAVEFORM (A) (NOTE 9)
SGT0640SBT	-6 to +6	4.2 at 50A	1	120	320
SGT0720SBT	-6 to +6	4.2 at 50A	1	120	320
SGT2300SBT	-5 to +4	3.2 at 50A	1	120	200
SGT2900SBT	-4 to +4	3.3 at 50A	1	120	200
SGT3100SBT	-4 to +4	3.3 at 50A	1	120	200
SGT0640SCT	-6 to +6	5.2 at 100A	1	250	600
SGT0720SCT	-6 to +6	5.2 at 100A	1	250	600
SGT1300SCT	-5 to +1	4.1 at 100A	1	250	600
SGT1500SCT	-5 to +1	4.1 at 100A	1	250	600
SGT2300SCT	-5 to +4	4.9 at 100A	1	250	500
SGT2900SCT	-4 to +4	7.2 at 100A	1	250	500
SGT3100SCT	-4 to +4	7.2 at 100A	1	250	500
SGT3500SCT	-3 to +4	7.7 at 100A	2	250	500

NOTES:

5. Typical percentage shift from normalized  $25^{\circ}C$  value (positive coefficient).
6. Typical maximum peak forward voltage drop at specified peak current.
7. Typical percentage shift with test frequency ranging from 1kHz to 1MHz/ $1V_{RMS}$  (for two constant DC bias voltages of 0V and 50V).
8.  $dI/dT$  for leading edge of sine wave where 1/2 rated  $I_{PP}$  is reached at initial  $30^{\circ}$  of the sine.
9. Rated  $I_{PP}$  value for the  $2 \times 10 \mu s$  waveform above which could cause device damage.

### Typical Performance Curves

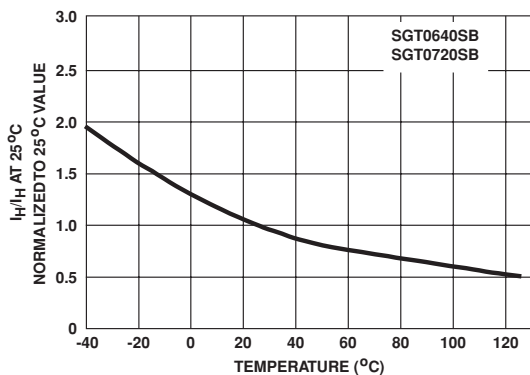

FIGURE 3. TYPICAL HOLDING CURRENT vs JUNCTION TEMPERATURE

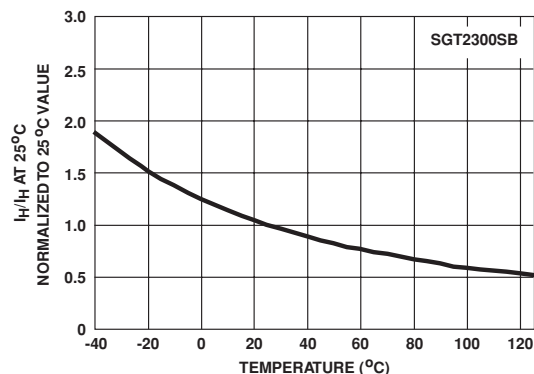

FIGURE 4. TYPICAL HOLDING CURRENT vs JUNCTION TEMPERATURE

### Surgeor Thyristors For Telecom Protection

#### Typical Performance Curves (Continued)

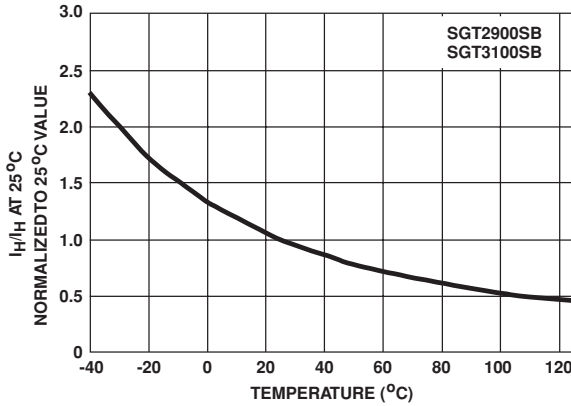

FIGURE 5. TYPICAL HOLDING CURRENT vs JUNCTION TEMPERATURE

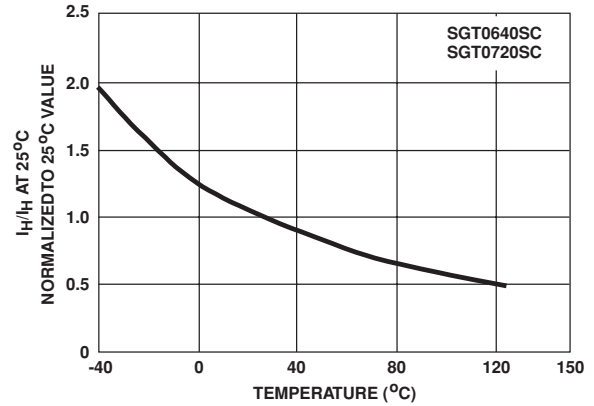

FIGURE 6. TYPICAL HOLDING CURRENT vs JUNCTION TEMPERATURE

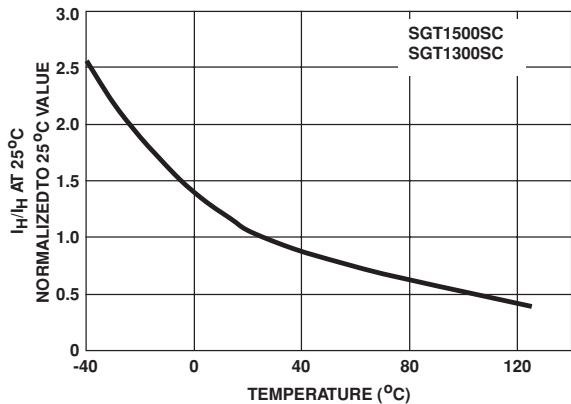

FIGURE 7. TYPICAL HOLDING CURRENT vs JUNCTION TEMPERATURE

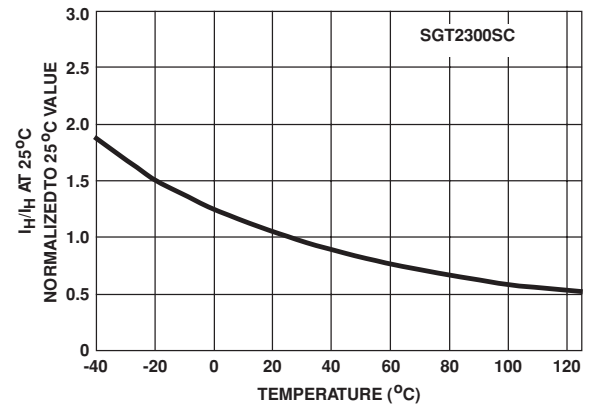

FIGURE 8. TYPICAL HOLDING CURRENT vs JUNCTION TEMPERATURE

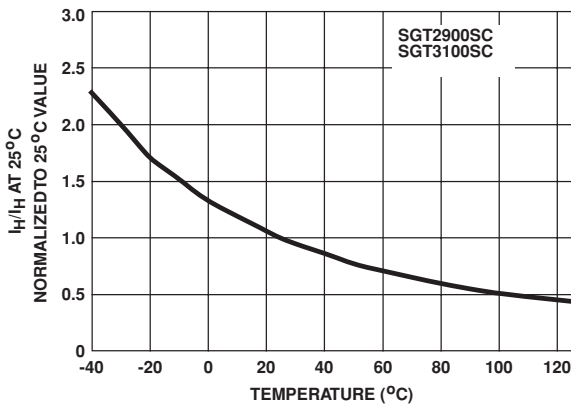

FIGURE 9. TYPICAL HOLDING CURRENT vs JUNCTION TEMPERATURE

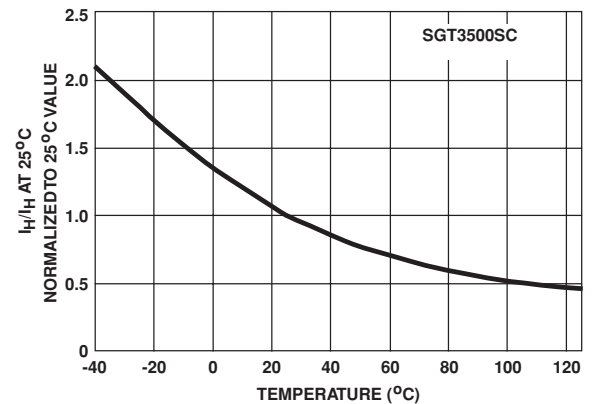

FIGURE 10. TYPICAL HOLDING CURRENT vs JUNCTION TEMPERATURE

# Surgeor Thyristors For Telecom Protection

### Typical Performance Curves (Continued)

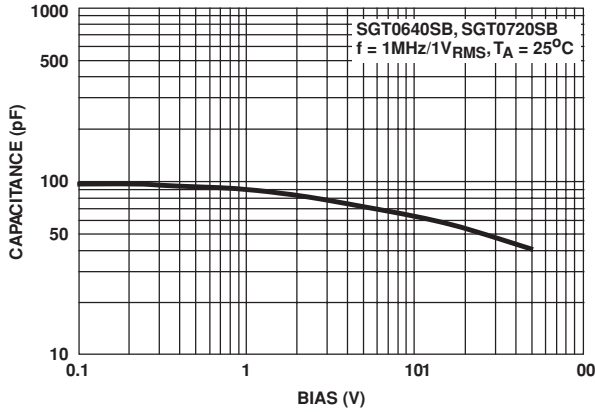

FIGURE 11. TYPICAL CAPACITANCE vs BIAS VOLTAGE

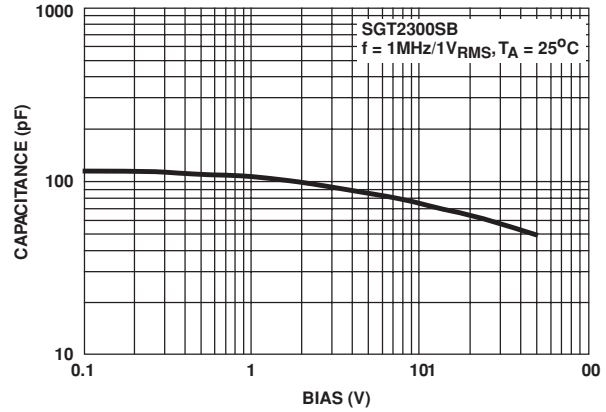

FIGURE 12. TYPICAL CAPACITANCE vs BIAS VOLTAGE

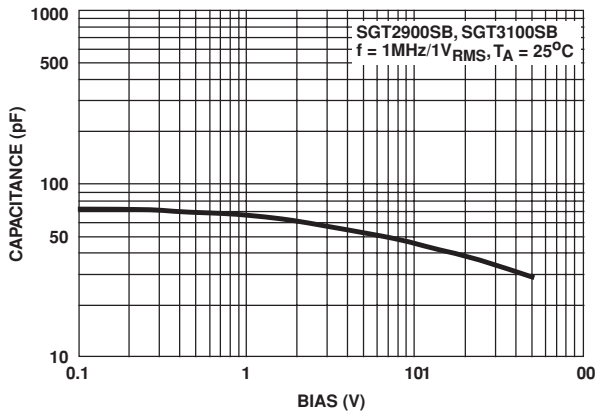

FIGURE 13. TYPICAL CAPACITANCE vs BIAS VOLTAGE

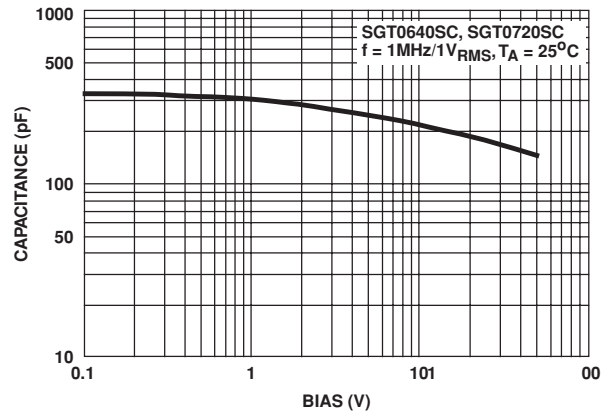

FIGURE 14. TYPICAL CAPACITANCE vs BIAS VOLTAGE

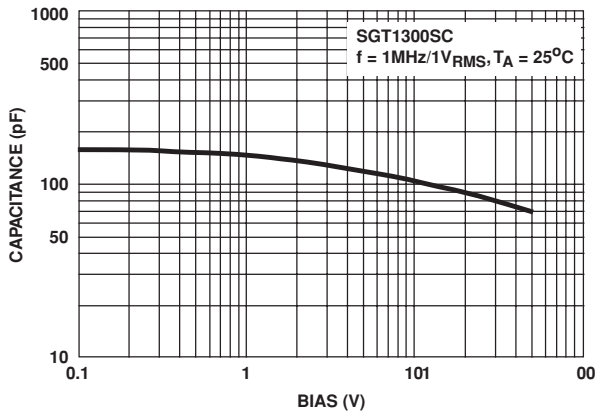

FIGURE 15. TYPICAL CAPACITANCE vs BIAS VOLTAGE

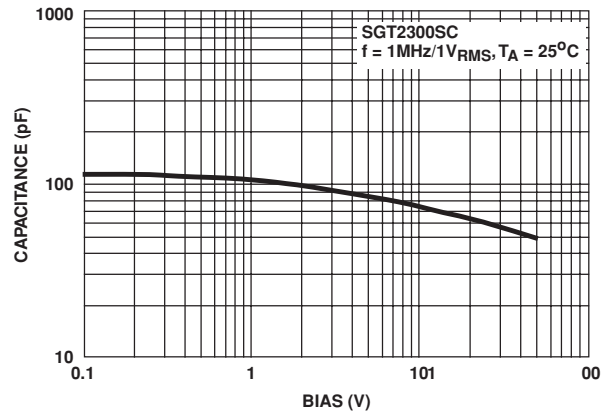

FIGURE 16. TYPICAL CAPACITANCE vs BIAS VOLTAGE

### Surgeor Thyristors For Telecom Protection

#### Typical Performance Curves (Continued)

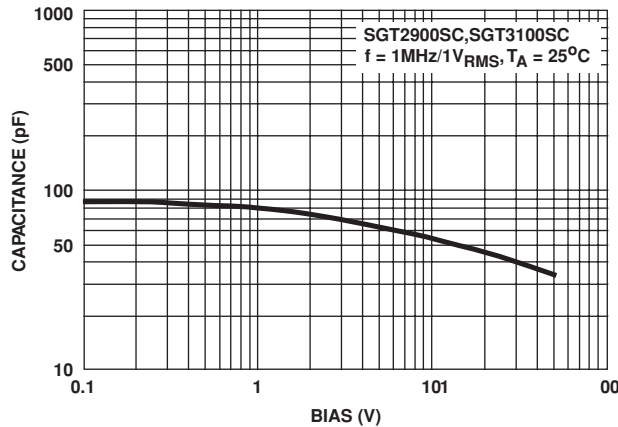

FIGURE 17. TYPICAL CAPACITANCE vs BIAS VOLTAGE

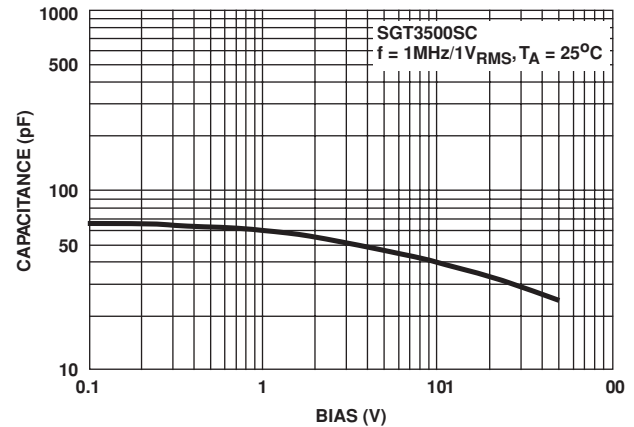

FIGURE 18. TYPICAL CAPACITANCE vs BIAS VOLTAGE

#### Recommended Surgeors for Typical Industry Standard Transient Specifications

INDUSTRY STANDARD	SPECIFIED PEAK VOLTAGE	SPECIFIED PEAK CURRENT	SPECIFIED CURRENT WAVESHAPES	RECOMMENDED SURGEOR I <sub>PP</sub> TYPE
GR1089	600V	100A	10 x 1000μs	C
GR1089	1000V	100A	10 x 360μs	C
GR1089	1000V	100A	10 x 1000μs	C
GR1089	2500V	500A	2 x 10μs	C
GR 1089	1000V	25A	10 x 360μs	B, C
FCC PART 68	800V	100A	10 x 560μs	C
FCC PART 68	1500V	200A	10 x 160μs	C
FCC PART 68	1000V	25A	5 x 320μs	B, C
FCC PART 68	1500V	38A	5 x 320μs	B, C
ITU K.20	1000V	25A	5 x 310μs	B, C
ITU K.20	1000V	50A	5 x 310μs	B, C
ITU K.20	4000V	100A	5 x 310μs	C
ITU K.20	4000V	200A	5 x 310μs	C
ITU K.21	1500V	75A	5 x 310μs	B, C
ITU K.21	4000V	200A	5 x 310μs	C
ITU K.21	1000V	25A	5 x 310μs	B, C
ITU K.21	4000V	100A	5 x 310μs	C

# Silicon Protection Circuits

## Surface Mount Surgeor™ Transient Voltage Suppressors

# Surgeor Thyristors For Telecom Protection

### Terms and Parameter Definitions

$V_{DRM}$  - Maximim Off-State Voltage (DC or Peak) which may be applied continuously.

$I_{DRM}$  - Maximum Reverse Current measured with  $V_{DRM}$  applied. (Off-State Current)

$V_T$  - Forward Voltage drop at the specified Forward Current  $I_T$ , in the On-State latched mode.

$V_{BO}$  - Maximum Breakover Voltage at which the device switches to the On-State latched mode.

$I_H$  - Minimum On-State Current required to maintain the device in the latched-on state.

$C_O$  - Terminal Capacitance measured at the specified off-state bias Voltage.

$I_{TSM}$  - Maximum Peak Surge Current at the specified AC cycle waveform.

$I_{PP}$  - Peak Pulse Surge Current rating of a designated waveform.

### Ordering Information

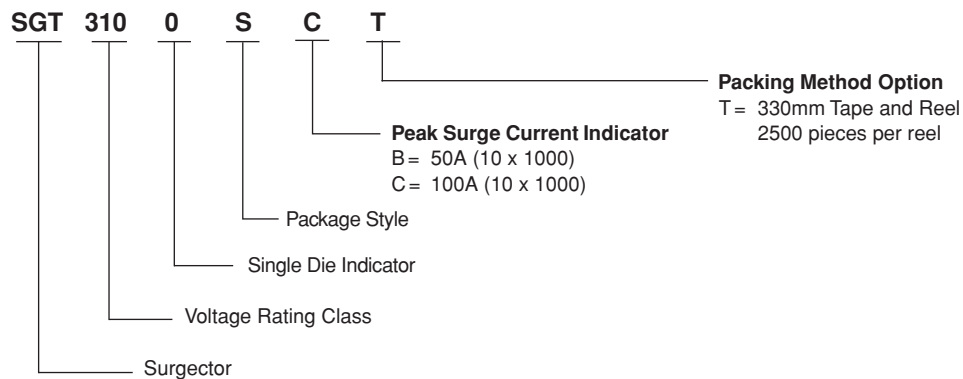

### Tape and Reel Specifications (Meets EIA-481-1)

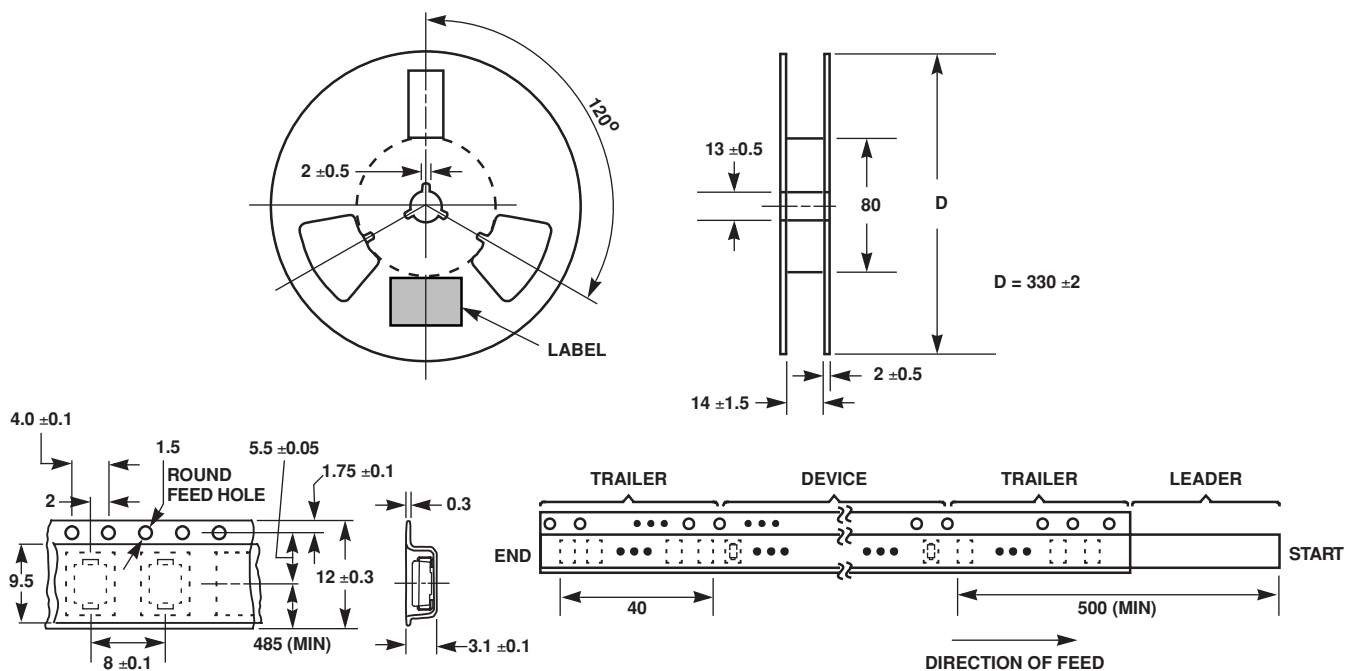



### Surgeor Thyristors For Telecom Protection

#### Branding Layout

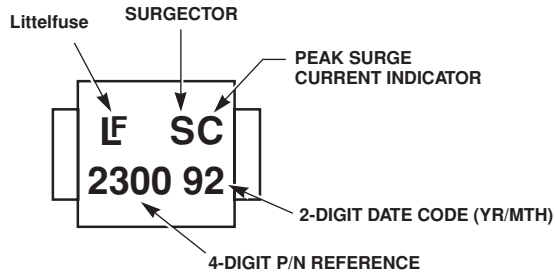

SGT2300SC (TOP VIEW - NOT TO SCALE)

#### Soldering Recommendations

Surface Mount Surgeors may be soldered with wave or reflow methods, and are compatible with common industry time-temperature profiles that include a preheat stage. When hand soldering, a 30W iron with a 1mm tip is recommended. The temperature should not exceed 300°C or a maximum 5 second duration.

#### Mechanical Outline Dimensions and Recommended Solder Pad Layout

