



Chipsmall Limited consists of a professional team with an average of over 10 year of expertise in the distribution of electronic components. Based in Hongkong, we have already established firm and mutual-benefit business relationships with customers from,Europe,America and south Asia,supplying obsolete and hard-to-find components to meet their specific needs.

With the principle of “Quality Parts,Customers Priority,Honest Operation,and Considerate Service”,our business mainly focus on the distribution of electronic components. Line cards we deal with include Microchip,ALPS,ROHM,Xilinx,Pulse,ON,Everlight and Freescale. Main products comprise IC,Modules,Potentiometer,IC Socket,Relay,Connector.Our parts cover such applications as commercial,industrial, and automotives areas.

We are looking forward to setting up business relationship with you and hope to provide you with the best service and solution. Let us make a better world for our industry!



## Contact us

Tel: +86-755-8981 8866 Fax: +86-755-8427 6832

Email & Skype: info@chipsmall.com Web: www.chipsmall.com

Address: A1208, Overseas Decoration Building, #122 Zhenhua RD., Futian, Shenzhen, China



# BMA253 Shuttle Board

## GENERAL DESCRIPTION

The Bosch Sensortec BMA253 shuttle-board is a PCB with a BMA253 acceleration sensor mounted on it. It allows easy access to the sensors pins via a simple socket. As all Bosch Sensortec sensor shuttle boards have identical footprint, they can be plugged into Bosch Sensortec's advanced development tools (e.g. the Development Board). Of course, the BMA253 shuttle board can also be used for customer's own implementations.

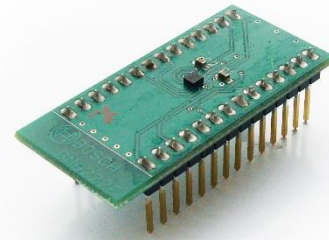

Note: Product photo may differ from real product's appearance.

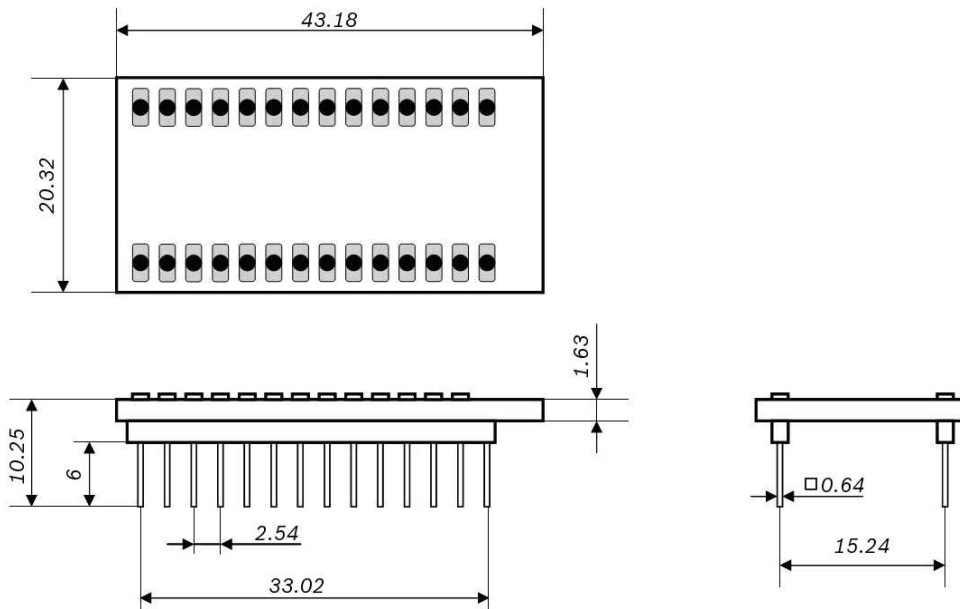

Shuttle board outline dimensions (all dimensions in mm)

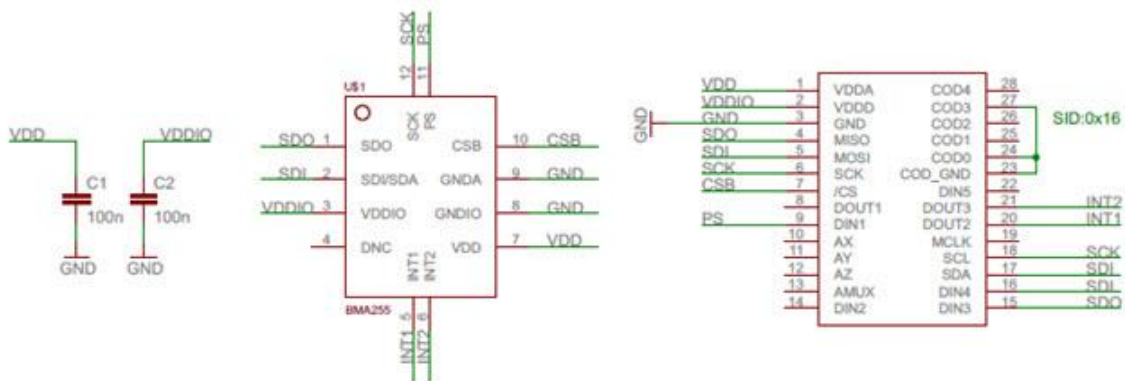

BMA253 shuttle board electrical layout

DELIVERABLES

- ▶ BMA253 shuttle board

**Headquarters**  
**Bosch Sensortec GmbH**  
 Gerhard-Kindler-Strasse 9  
 72770 Reutlingen · Germany  
 Telephone +49 7121 3535 900  
 Fax +49 7121 3535 909  
[www.bosch-sensortec.com](http://www.bosch-sensortec.com)