



Chipsmall Limited consists of a professional team with an average of over 10 year of expertise in the distribution of electronic components. Based in Hongkong, we have already established firm and mutual-benefit business relationships with customers from,Europe,America and south Asia,supplying obsolete and hard-to-find components to meet their specific needs.

With the principle of “Quality Parts,Customers Priority,Honest Operation,and Considerate Service”,our business mainly focus on the distribution of electronic components. Line cards we deal with include Microchip,ALPS,ROHM,Xilinx,Pulse,ON,Everlight and Freescale. Main products comprise IC,Modules,Potentiometer,IC Socket,Relay,Connector.Our parts cover such applications as commercial,industrial, and automotives areas.

We are looking forward to setting up business relationship with you and hope to provide you with the best service and solution. Let us make a better world for our industry!



Contact us

Tel: +86-755-8981 8866 Fax: +86-755-8427 6832

Email & Skype: info@chipsmall.com Web: www.chipsmall.com

Address: A1208, Overseas Decoration Building, #122 Zhenhua RD., Futian, Shenzhen, China



SI-8000S Series Full-Mold, Separate Excitation Step-down Switching Mode

Features

- Compact full-mold package (equivalent to TO220)
- Output current: 3.0A
- High efficiency: 79 to 91%
- Requires only 4 discrete components
- Internally-adjusted phase correction and output voltage
- Built-in reference oscillator (60kHz)
- Built-in overcurrent and thermal protection circuits
- Built-in soft start circuit (Output ON/OFF available)

Lineup

Part Number	SI-8033S	SI-8050S	SI-8090S	SI-8120S	SI-8150S
Vo(V)	3.3	5.0	9.0	12.0	15.0
Io(A)	3.0				

Absolute Maximum Ratings

Parameter	Symbol	Ratings	Unit
DC Input Voltage	V _{IN}	43*	V
Power Dissipation	P _{D1}	18(With infinite heatsink)	W
	P _{D2}	1.5(Without heatsink, stand-alone operation)	W
Junction Temperature	T _j	+125	°C
Storage Temperature	T _{stg}	-40 to +125	°C
SW Terminal Applied Reverse Voltage	V _{sw}	-1	V
Thermal Resistance(junction to case)	θ _{jc}	5.5	°C/W

*35V for SI-8033S

Applications

- Power supplies for telecommunication equipment
- Onboard local power supplies

Recommended Operating Conditions

Parameter	Symbol	Ratings					Unit
		SI-8033S	SI-8050S	SI-8090S	SI-8120S	SI-8150S	
DC Input Voltage Range	V _{IN}	5.5 to 28	7 to 40	12 to 40	15 to 40	18 to 40	V
Output Current Range	I _o	0 to 3.0					A
Operating Junction Temperature Range	T _{op}	-30 to +125					°C

Electrical Characteristics

(T_a=25°C)

Parameter	Symbol	Ratings															Unit
		SI-8033S			SI-8050S			SI-8090S			SI-8120S			SI-8150S			
Output Voltage	Vo	min.	typ.	max.	min.	typ.	max.	min.	typ.	max.	min.	typ.	max.	min.	typ.	max.	V
		SI-8000S*1	3.17	3.30	3.43	4.80	5.00	5.20	8.55	9.00	9.45	11.50	12.00	12.50	14.25	15.00	
Efficiency	η	SI-8000SS			SI-8000SS			SI-8000SS			SI-8000SS			SI-8000SS			%
		3.234	3.30	3.366	4.90	5.00	5.10	-----			-----			-----			
Oscillation Frequency	f	Conditions			Conditions			Conditions			Conditions			Conditions			kHz
		V _{IN} =15V, I _o =1.0A	V _{IN} =20V, I _o =1.0A	V _{IN} =21V, I _o =1.0A	V _{IN} =24V, I _o =1.0A	V _{IN} =25V, I _o =1.0A	79	84	88	90	91	60	60	60	60	60	
Line Regulation	ΔV _{OLINE}	Conditions			Conditions			Conditions			Conditions			Conditions			mV
		V _{IN} =8 to 28V, I _o =1.0A	V _{IN} =10 to 30V, I _o =1.0A	V _{IN} =15 to 30V, I _o =1.0A	V _{IN} =18 to 30V, I _o =1.0A	V _{IN} =21 to 30V, I _o =1.0A	25	80	40	100	50	120	60	130	60	130	
Load Regulation	ΔV _{LOAD}	Conditions			Conditions			Conditions			Conditions			Conditions			mV
		V _{IN} =15V, I _o =0.5 to 1.5A	V _{IN} =20V, I _o =0.5 to 1.5A	V _{IN} =21V, I _o =0.5 to 1.5A	V _{IN} =24V, I _o =0.5 to 1.5A	V _{IN} =25V, I _o =0.5 to 1.5A	10	30	10	40	10	40	10	40	10	40	
Temperature Coefficient of Output Voltage	ΔVo/ΔTa	±0.5			±0.5			±1.0			±1.0			±1.0			mV/°C
Overcurrent Protection Starting Current	I _{st}	3.1			3.1			3.1			3.1			3.1			A
		Conditions			Conditions			Conditions			Conditions			Conditions			
Soft Start Pin*2	V _{SSL}	0.2			0.2			0.2			0.2			0.2			V
		Conditions			Conditions			Conditions			Conditions			Conditions			
Outflow Current at Low Voltage	I _{SSL}	15			15			15			15			15			μA
		V _{SSL} =0.2V															

*1: "S" may be printed to the right of the marking (except SI-8090S, SI-8120S, SI-8150S).

*2: Pin 5 is a soft start pin. Soft start at power on can be performed with a capacitor connected to this pin.

The output can also be turned ON/OFF with this pin.

The output is stopped by setting the voltage of this pin to V_{SSL} or lower.

Soft-start pin voltage can be changed with an open-collector drive circuit of a transistor.

When using both the soft-start and ON/OFF functions together, the discharge current from C₃ flows into the ON/OFF control transistor. Therefore, limit the current securely to protect the transistor if C₃ capacitance is large.

The ON/OFF pin is pulled up to the power supply in the IC, so applying the external voltage is prohibited.

If this pin is not used, leave it open.

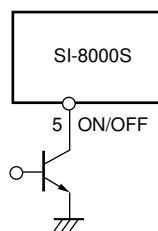

V_{OUT}. ON/OFF

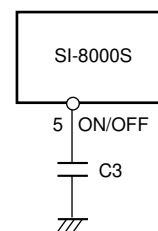

Soft start

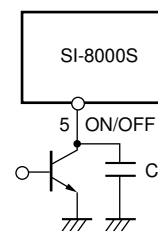

Soft start +V_{OUT}. ON/OFF

External Dimensions (TO220F-5)

(Unit : mm)

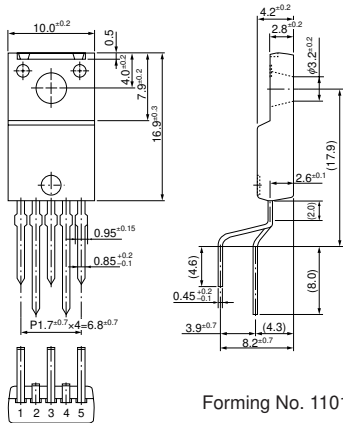

Pin Assignment

- ① VIN
- ② SWout
- ③ GND
- ④ Vos
- ⑤ S.S

Plastic Mold Package Type
 Flammability: UL94V-0
 Product Mass: Approx. 2.3g

Block Diagram

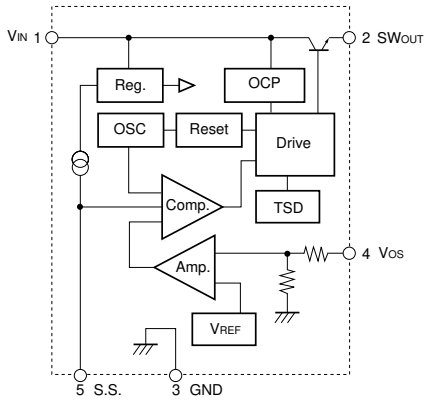

Typical Connection Diagram

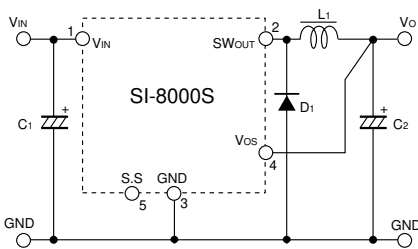

- C_{1,2} : 1000μF
- L₁ : 150μH
- D₁ : RK46(Sanken)

T_a-P_d Characteristics

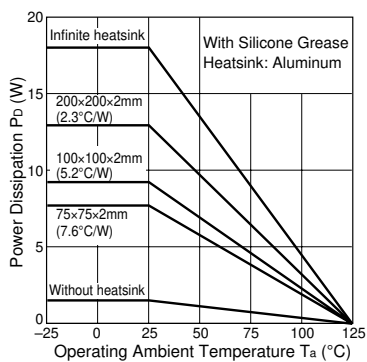

$$P_D = V_O \cdot I_O \left(\frac{100}{\eta \chi} - 1 \right) - V_F \cdot I_O \left(1 - \frac{V_O}{V_{IN}} \right)$$

The efficiency depends on the input voltage and the output current. Therefore, obtain the value from the efficiency graph and substitute the percentage in the formula above.

- V_O : Output voltage
- V_{IN} : Input voltage
- I_O : Output current
- ηχ : Efficiency (%)
- V_F : Diode D₁ forward voltage
0.5V(RK46)

Thermal design for D₁ must be considered separately.