



Chipsmall Limited consists of a professional team with an average of over 10 year of expertise in the distribution of electronic components. Based in Hongkong, we have already established firm and mutual-benefit business relationships with customers from,Europe,America and south Asia,supplying obsolete and hard-to-find components to meet their specific needs.

With the principle of “Quality Parts,Customers Priority,Honest Operation,and Considerate Service”,our business mainly focus on the distribution of electronic components. Line cards we deal with include Microchip,ALPS,ROHM,Xilinx,Pulse,ON,Everlight and Freescale. Main products comprise IC,Modules,Potentiometer,IC Socket,Relay,Connector.Our parts cover such applications as commercial,industrial, and automotives areas.

We are looking forward to setting up business relationship with you and hope to provide you with the best service and solution. Let us make a better world for our industry!



Contact us

Tel: +86-755-8981 8866 Fax: +86-755-8427 6832

Email & Skype: info@chipsmall.com Web: www.chipsmall.com

Address: A1208, Overseas Decoration Building, #122 Zhenhua RD., Futian, Shenzhen, China



LED Module

LT-H562A
LT-H282A
LT-H072A



Features & Benefits

- Easy connection with re-workable poke-in connector
- Fit better to replace conventional T5, T8 fixture with narrow width
- Full Certifications

Applications

Indoor Lighting:

- Office / Retail/ Living space
- Area Panels, Troffer and Linear Pendants
- Channel and Cove lighting

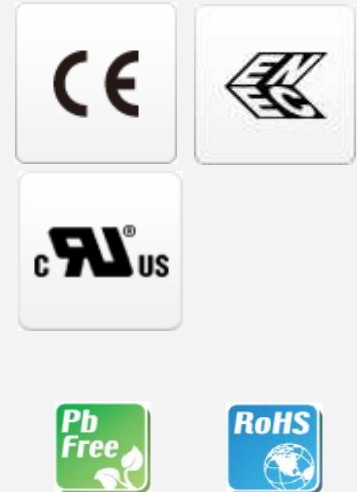

Table of Contents

1.	Product Code Information	-----	3
2.	Characteristics	-----	4
3.	Structure and Assembly	-----	6
4.	Certification and Declaration	-----	9
5.	Label Structure	-----	10
6.	Packing Structure	-----	12
7.	Precautions in Handling & Use	-----	13

1. Product Code Information

Model	Nominal CCT (K)	Product Code
LT-H072A	3000	SI-B8V031070WW
	3500	SI-B8U031070WW
	4000	SI-B8T031070WW
	5000	SI-B8R031070WW
LT-H282A	3000	SI-B8V102280WW
	3500	SI-B8U102280WW
	4000	SI-B8T102280WW
	5000	SI-B8R102280WW
LT-H562A	3000	SI-B8V201560WW
	3500	SI-B8U201560WW
	4000	SI-B8T201560WW
	5000	SI-B8R201560WW

2. Characteristics

Item	Rating	Unit	Remark
Rated Lifetime	>50,000	hour	L70B50 @ $t_p = 85^\circ\text{C}$
Ingress Protection (IP)	no rating	-	
Ambient / Operating Temperature (t_{amb})	-20 ~ +50	$^\circ\text{C}$	
Storage Temperature	-30 ~ +80	$^\circ\text{C}$	

a) H072A

Item	Nom. CCT (K)	Rating			Unit	Remark
		Min	Typ.	Max		
Luminous Flux (Φ_v)	3000	320	350	380	lm	$I_f = 300\text{ mA}$ $t_p = 50^\circ\text{C}$
	3500	325	360	390		
	4000	335	370	400		
	5000	345	380	410		
Luminous Efficacy	3000	113	124	134	lm/W	
	3500	115	126	138		
	4000	118	131	141		
	5000	122	134	145		
CCT	3000	2957	3049	3142	K	
	3500	3303	3422	3539		
	4000	3796	3948	4100		
	5000	4798	5050	5307		
Color Consistency (initial)	3000	-	3	-	MacAdam step	
	3500					
	4000					
	5000					
Color Rendering Index (Ra)		80	-	-	-	
Operating Current (I_f)		-	300	360	mA	-
Operating Voltage (V_f)		8.51	9.45	10.40	Vdc	$I_f = 300\text{ mA}$
Power Consumption		2.6	2.8	3.1	W	$t_p = 50^\circ\text{C}$

b) H282A

Item	Nom. CCT (K)	Rating			Unit	Remark
		Min	Typ.	Max		
Luminous Flux (Φ_v)	3000	1185	1290	1395	lm	$I_f = 300\text{ mA}$ $t_p = 50^\circ\text{C}$
	3500	1205	1310	1415		
	4000	1255	1365	1475		
	5000	1280	1390	1505		
Luminous Efficacy	3000	115	125	136	lm/W	

	3500	117	127	138		
	4000	122	132	143		
	5000	124	135	146		
CCT	3000	2958	3051	3145	K	
	3500	3303	3422	3542		
	4000	3813	3968	4123		
	5000	4820	5074	5336		
Color Consistency (initial)	3000	-	3	-	MacAdam step	
	3500					
	4000					
	5000					
Color Rendering Index (Ra)		80	-	-	-	
Operating Current (I _f)		-	300	360	mA	-
Operating Voltage (V _f)		30.9	34.3	37.7	Vdc	I _f = 300 mA
Power Consumption		9.3	10.3	11.3	W	t _p = 50 °C

c) H562A

Item	Nom. CCT (K)	Rating			Unit	Remark
		Min	Typ.	Max		
Luminous Flux (Φ _v)	3000	2370	2580	2785	lm	
	3500	2410	2620	2830		
	4000	2505	2725	2945		
	5000	2560	2785	3010		
Luminous Efficacy	3000	116	126	137	lm/W	I _f = 300 mA t _p = 50 °C
	3500	118	128	139		
	4000	123	134	144		
	5000	125	136	148		
CCT	3000	2957	3050	3142	K	
	3500	3311	3429	3547		
	4000	3806	3958	4109		
	5000	4795	5046	5299		
Color Consistency (initial)	3000	-	3	-	MacAdam step	
	3500					
	4000					
	5000					
Color Rendering Index (Ra)		80	-	-	-	
Operating Current (I _f)		-	300	360	mA	-
Operating Voltage (V _f)		61.2	68.0	74.8	Vdc	I _f = 300 mA
Power Consumption		18.4	20.4	22.4	W	t _p = 50 °C

Notes:

- 1) t_p: temperature at which performance is specified; measured at “Tc point”.

2) Samsung maintains a measurement tolerance of: Luminous flux: $\pm 7\%$, CRI: ± 3.0 , Voltage: ± 0.3 V.

Item	Nominal*	Life**	Max***	Unit
Temperature	50 (t_p)	85 ($t_{p, 50}$)	90 (t_c)	°C

Notes:

- * Temperature used to specify performance of the module (t_p).
 - ** Rated maximum performance temperature at which lifetime is specified ($t_{p, 50}$).
 - *** Rated maximum temperature, highest permissible temperature to avoid safety risk (t_c).
- All temperatures are measured at the designated “Tc point” as indicated on the module.

3. Structure and Assembly

a) Appearance

H072A



H282A



H562A



b) Dimension

H072A

imension	Specification	Tolerance	Unit
Module Length	70.0	± 0.4	mm
Module Width	24.0	± 0.3	mm
Module Height	5.8	± 0.3	mm
PCB Thickness	1.6	± 0.16	mm
Module Weight	6.1	± 0.3	g

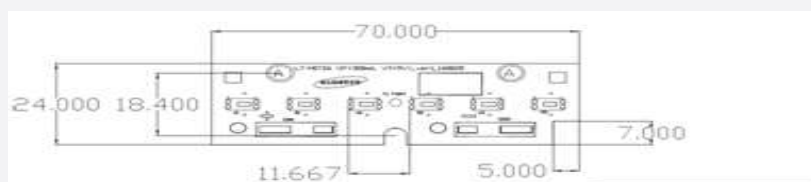

H282A

imension	Specification	Tolerance	Unit
Module Length	280.0	± 0.5	mm
Module Width	24.0	± 0.3	mm
Module Height	5.8	± 0.3	mm
PCB Thickness	1.6	± 0.16	mm
Module Weight	22.4	± 0.3	g

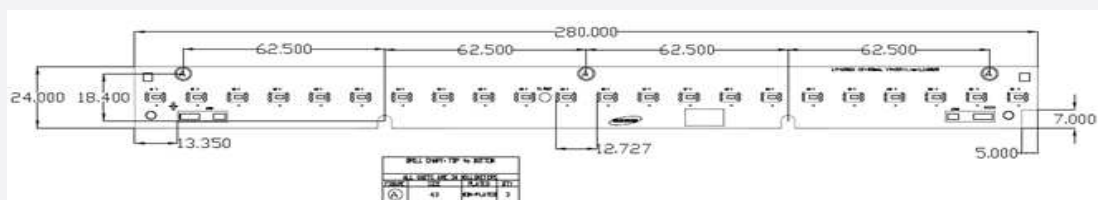

H562A

imension	Specification	Tolerance	Unit
Module Length	560.0	± 0.5	mm
Module Width	24.0	± 0.3	mm
Module Height	5.8	± 0.3	mm
PCB Thickness	1.6	± 0.16	mm
Module Weight	43.0	± 2.2	g

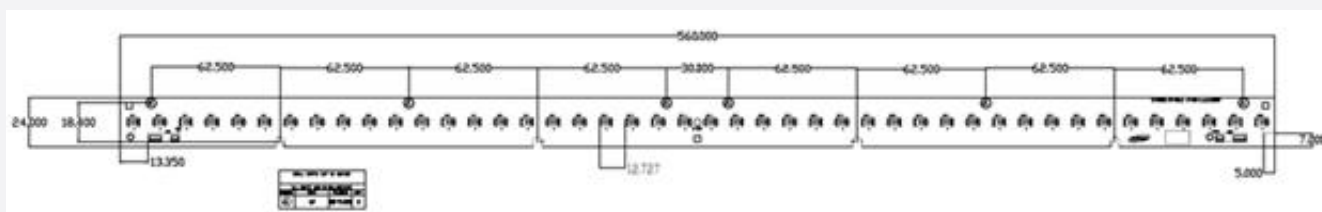

c) Assembly

Connectors on the board are provided for easy wiring with the LED driver and between modules



d) Structure

Item	Specification
LED	LM561B Middle Power LED
PCB	Material: copper, solder mask, epoxy
Connector	Reworkable poke-in connector type
Wire	24~18 AWG; terminal strip length of 7.5~8.5 mm

e) Light Distribution

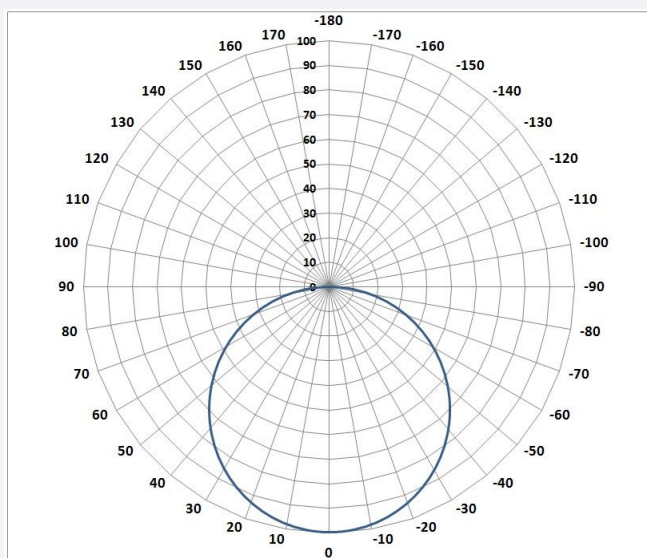

f) Thermal Management

Performance temperatures are measured on “Tc point” as indicated on the module.

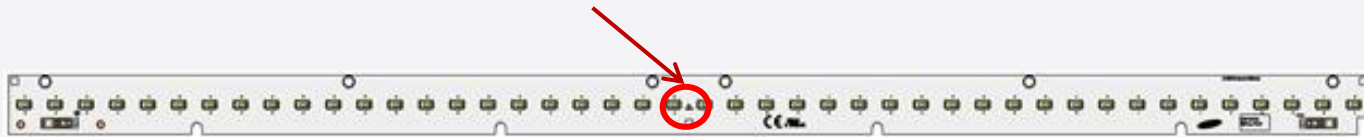

g) Schematic Circuit

H072A

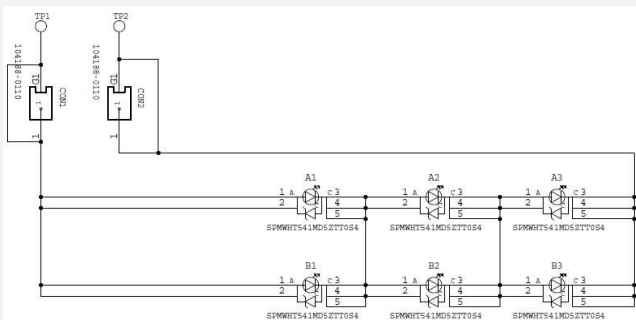

H282A

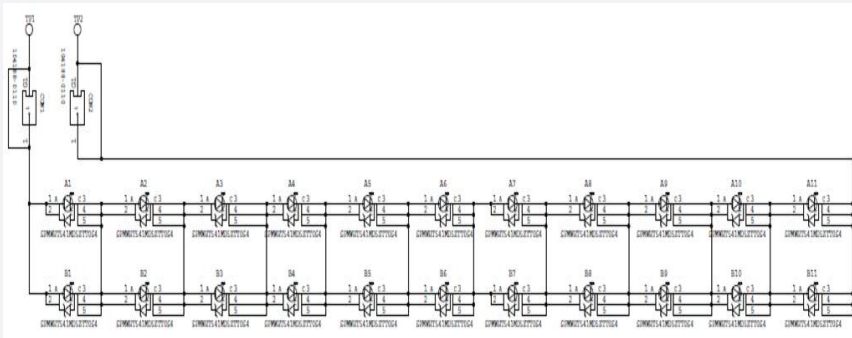

H562A

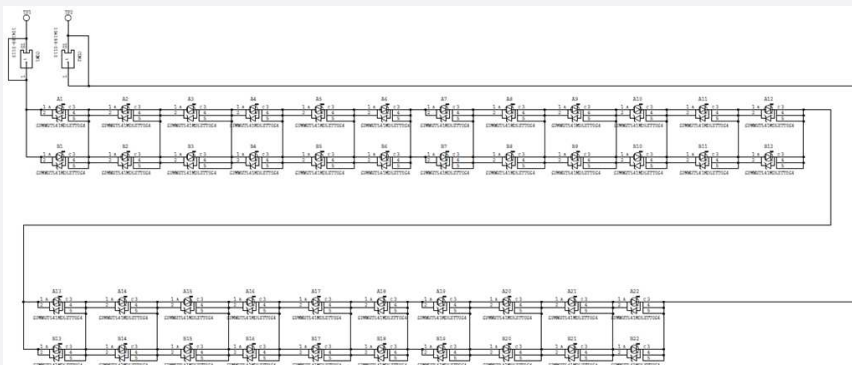

4. Certification and Declaration

Item	Compliant to	Remark
Test & Certification	CE	IEC / EN 62031, IEC / EN 62471
	ENEC	IEC / EN 62031, IEC / EN 62471
	UL / cUL for Component	UL 8750
	Photobiological Safety (LM561B LED)	IEC / EN 62471
Declaration	RoHS	Hazardous Substance & Material
	REACH	Hazardous Substance & Material

5. Label Structure

a) Module Label

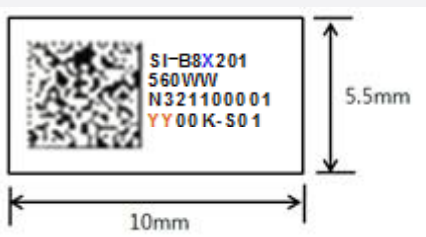

The lot number is composed of the following characters:

A. Barcode type : 2-dimensional data matrix code

B. Information of Barcode

① Example : SI-B8X071300WW_K2241000014000K-S01



② 38 digits: Model code (15) + Space (1) + SMT date (4) + SMT line No (1) + Serial No.(5)
+ Color temperature (5) + LED maker (2) + GROUP No (2)

C. Number information

① Model code: SI-B8X071300WW

X: W (2700K), V (3000K), U (3500K), T (4000K), R (5000K)

② Space: Space

③ SMT date: K224 (2010-February-24th)

A (2000), B(2001) ······ J(2009), K(2010), L(2011), ······ (year)

1(January), 2(February), ······ 9(September), A(October), B(November), C(December) (month)

01, 02, ······ 31th (date)

④ SMT Line No. : 1 line

1~9, A(10), B(11), C(12), D(13), E(14), F(15)

⑤ Serial No: 00001

00001~99999: Setting "00001" every working day

⑥ Color temperature: YZ00K

Y : 27, 30, 35, 40, 50

⑦ LED Maker: -S (Samsung)

⑧ Group No: 01 (Binning group)

b) Box Label

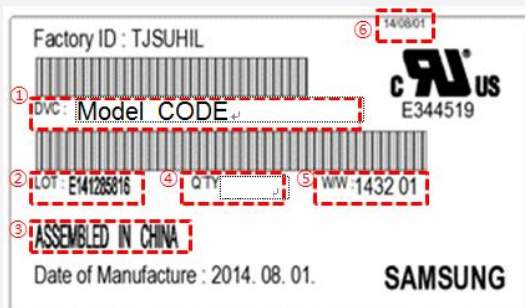

The lot number is composed of the following characters:

- ① : Product code
- ② : Lot ID
- ③ : Place of origin
- ④ : Quantity
- ⑤ : Describe production week
- ⑥ : Date of Issue

6. Packing Structure

a) Packing Process

H072A

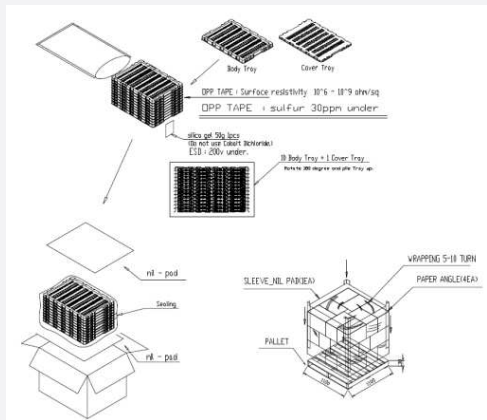

H282A

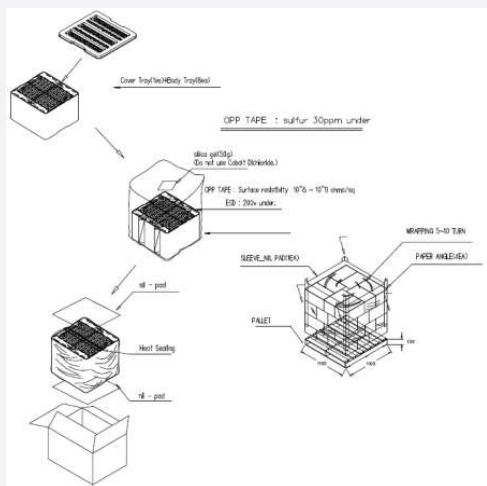

H562A

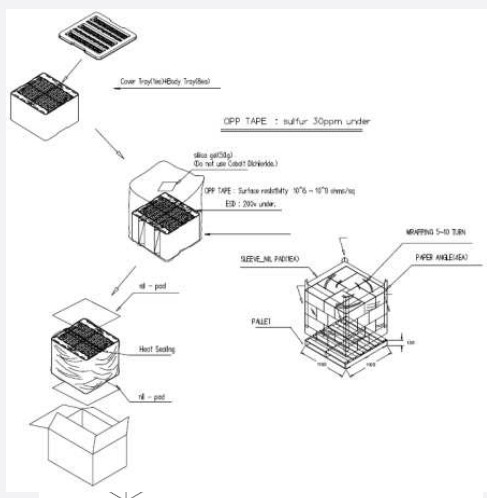

b) Packing**H072A**

Packing	Quantity (modules)	Dimension (mm)			
		Length	Width	Height	Tolerance
Outer Box	1500	430	310	275	±5
Pallet	36000	1100	1100	130	-

H282A

Packing	Quantity (modules)	Dimension (mm)			
		Length	Width	Height	Tolerance
Outer Box	320	385	335	225	±5
Pallet	10240	1100	1100	130	-

H562A

Packing	Quantity (modules)	Dimension (mm)			
		Length	Width	Height	Tolerance
Outer Box	240	615	335	225	±5
Pallet	3840	1100	1100	130	-

7. Precautions in Handling & Use

A. The LED Lighting Modules for white light are devices which are materialized by combining white LEDs.

The color of white light can differ a little unusually to diffuser plate(sign-board panel).

Also when the LEDs are illuminating, operating current should be decided after considering the ambient maximum temperature.

B. Handling

To prevent the LED Lighting Modules from making any defectives, please handle the LED Lighting Modules with care as follows.

- (1) Don't drop the unit and don't give the unit any shocks.
- (2) Don't bend the PCB and don't touch the LED Resin.
- (3) Don't storage the Module in a dusty place or room.
- (4) Don't take the product apart.
- (5) Don't touch the LED and also PCB and other circuit parts of Module with your naked fingers or sharpness things.
- (6) Take care so that do not pull wire with hand in case of carries or moves LED Lighting Modules.

C. Cleaning

The LED Lighting Modules should not be used in any type of fluid such as water, oil, organic solvent, etc.

It is recommended that IPA (Isopropyl Alcohol) be used as a solvent for cleaning the LED Lighting Modules.

When using other solvents, it should be confirmed beforehand whether the solvents will dissolve the package and the resin or not. Freon solvents should not be used to clean the LEDs because of worldwide regulations. Do not clean the LED Lighting Modules by the ultrasonic.

Before cleaning, a pre-test should be done to confirm whether any damage to the LED Lighting Modules will occur.

D. Static Electricity

Static electricity or surge voltage damages the LED Lighting Modules. Please keep the working process anti-static electricity condition to prevent the Lighting from destroying, as following.

- (1) Anyone who handles the unit should be well grounded.(earth ring or anti-static glove)
- (2) Anyone who handles the unit should wear anti-electrostatic working clothes.
- (3) All kinds of device and instruments, such as working table, measuring instruments and assembly jigs in your production lines should be well grounded.

E. Storage

The LED Lighting Modules must be stored to insert a package of a moisture absorbent material(silica gel) in a box.

F. Others

If over voltage which exceeds the absolute maximum rating is applied to LED Lighting Modules.

It will cause damage Circuits(that LED is included) and result in destruction.

Do not directly look into lighted LED with naked eyes.

Please use this product within 5 months, which is kept in its original packaging unopened when stocked

Legal and additional information.

[About Samsung Electronics Co., Ltd.](#)

Samsung Electronics Co., Ltd. is a global leader in technology, opening new possibilities for people everywhere. Through relentless innovation and discovery, we are transforming the worlds of TVs, smartphones, tablets, PCs, cameras, home appliances, printers, LTE systems, medical devices, semiconductors and LED solutions. We employ 286,000 people across 80 countries with annual sales of US\$216.7 billion. To discover more, please visit www.samsungled.com.

Copyright © 2015 Samsung Electronics Co., Ltd. All rights reserved.
Samsung is a registered trademark of Samsung Electronics Co., Ltd.
Specifications and designs are subject to change without notice. Non-metric weights and measurements are approximate. All data were deemed correct at time of creation. Samsung is not liable for errors or omissions. All brand, product, service names and logos are trademarks and/or registered trademarks of their respective owners and are hereby recognized and acknowledged.

Samsung Electronics Co., Ltd.
95, Samsung 2-ro
Giheung-gu
Yongin-si, Gyeonggi-do, 446-711
KOREA

www.samsungled.com

